



**Weasler**<sup>®</sup>



North American  
Drivelines and Components



Metric Drivelines  
and Components



Constant Velocity  
Drivelines and Components



Clutches



Sprockets, Hubs  
and Pulleys

# Aftermarket

Product Guide

2021



**Weasler<sup>®</sup>**

Weasler Engineering is a global leader in the manufacture and distribution of mechanical power transmission solutions for all varieties of agricultural machinery. Farming, lawn and turf, construction, industrial, and marine OEMs worldwide look to us for innovative and dependable drive train systems and components. Founded in 1951, the Weasler brand is widely recognized for unsurpassed quality, on-time delivery, consistent reliability, and exceptional service.

**[www.weasler.com](http://www.weasler.com)**



**Weasler<sup>®</sup>**

Weasler Engineering is part of the CentroMotion organization, a privately held, growing portfolio of highly respected global brands that add value through innovative motion, actuation and control technologies. Our skilled subject matter experts develop solutions that enable our global customers' products to be smarter, safer and more productive, while also creating value for our investors. Learn more about CentroMotion at:

[www.centromotion.com](http://www.centromotion.com)

## TABLE OF CONTENTS

<b>SAFETY SECTION .....</b>	<b>1</b>
Warning & Safety Decals .....	2
Easy Lock Guard System .....	3
Greasing Recommendations .....	4
Driveline Length Adjustment .....	6
<b>QUICK REFERENCE SECTION.....</b>	<b>7</b>
Cross & Bearing Kit Interchange.....	8
Shafting & Tubing.....	11
Universal Joint Replacement .....	12
Easy Lock Guarding System.....	13
Nylon Bearing Repair Kit.....	15
80° Constant Velocity Driveline Replacement Chart .....	16
1000 Series Cross Reference.....	17
Locking Device & Locking Device Repair Kit.....	18
General Unit Conversion.....	19
<b>DRIVELINE REPLACEMENT APPLICATIONS SECTION .....</b>	<b>21</b>
<b>NORTH AMERICAN DRIVELINE &amp; COMPONENT SECTION .....</b>	<b>45</b>
Part Number Identification .....	46
North American Transparency Identification System .....	47
6 Series.....	48
12 Series.....	53
14 Series.....	57
35 Series.....	62
44 Series.....	67
55 Series.....	72
77 Series.....	76
W Series .....	78
0675 Series.....	80
1000 Series.....	81
Miscellaneous .....	84
2600 Series.....	85
Shafting & Tubing.....	86
Shock Absorbing Flexible Coupling Disc .....	86
Locking Device & Locking Device Repair Kit.....	87
<b>METRIC DRIVELINE &amp; COMPONENT SECTION .....</b>	<b>89</b>
Metric Transparency Identification System .....	90
Part Number Identification .....	91
1 Series - Bondioli & Pavesi.....	92
2 Series - Bondioli & Pavesi.....	95
3 Series - Bondioli & Pavesi.....	98
4 Series - Bondioli & Pavesi.....	101
5 Series - Bondioli & Pavesi.....	104
6 Series - Bondioli & Pavesi.....	107
7N Series - Bondioli & Pavesi.....	109
8 Series - Bondioli & Pavesi.....	113
9 Series - Bondioli & Pavesi.....	116
2100/100 Series - Walterscheid.....	119
2200/200 Series - Walterscheid.....	121
I Series - Walterscheid.....	123
2300/210 Series - Walterscheid.....	125
220/720 Series - Walterscheid.....	128

## TABLE OF CONTENTS

### **METRIC DRIVELINE & COMPONENT SECTION ... continued.....**

<i>2400 Series - Walterscheid</i> .....	130
<i>2500 Series - Walterscheid</i> .....	133
<i>2600 Series - Walterscheid</i> .....	136
<i>II Series - Walterscheid</i> .....	138
<i>Shafting &amp; Tubing</i> .....	139
<i>Metric Replacement Drivelines</i> .....	140
<i>Q.D. Repair Kit</i> .....	143

### **CONSTANT VELOCITY DRIVELINES AND COMPONENTS SECTION... 145**

<i>North American 80° CV Category 3 / 14</i> .....	146
<i>North American 80° CV Category 4 / 35</i> .....	149
<i>North American 80° CV Category 5 / 35/44</i> .....	153
<i>North American 80° CV Category 6 / 55</i> .....	158
<i>50° Constant Velocity Driveline</i> .....	164
<i>Metric 80° CV Category 3 / 2380</i> .....	166
<i>Metric 80° CV Category 4 / 2480</i> .....	168
<i>Metric 80° CV Category 6 / 2580</i> .....	172
<i>Metric 80° CV Tri-Lobe</i> .....	177

### **CLUTCH SECTION ..... 179**

<i>TorqMaster Part Number Identification</i> .....	180
<i>TorqMaster Features and Benefits</i> .....	181
<i>TorqMaster Assembly Instructions</i> .....	182
<i>Clutch Pak Selection Guide</i> .....	183
<i>North American Clutch Components</i> .....	185
<i>Metric Clutch Components</i> .....	188
<i>Replacement Clutch Applications - Features and Benefits</i> .....	194

### **SPROCKETS, HUBS, & PULLEYS SECTION..... 197**

<i>Welding Instructions</i> .....	198
<i>Sprocket &amp; Hub Part Number System</i> .....	198
<i>Sprockets</i> .....	199
<i>Hubs</i> .....	203
<i>Pulleys</i> .....	205

### **JAW COUPLING SECTION ..... 207**

<i>Jaw Coupling Part Numbers</i> .....	208
--	-----

### **MERCHANDISERS SECTION..... 209**

<i>All Purpose Driveline Display</i> .....	210
<i>North American &amp; Metric Rack Displays</i> .....	211
<i>North American Driveline Components Display</i> .....	212
<i>North American Driveline Components 44/55 Series Display</i> .....	213
<i>Metric Driveline Components Display</i> .....	214
<i>Sprockets, Hubs &amp; Pulleys Display</i> .....	215
<i>Sprockets Display Components</i> .....	216



**Weasler**<sup>®</sup>

## Aftermarket Product Guide



# Safety

# SAFETY SECTION

## WARNING!

- Be certain to disengage PTO shaft and to turn off the tractor before making any operational maintenance inspections or repairs. Keep clear of the machine until all parts have stopped moving.
- NEVER operate an implement with driveline guards missing or in a damaged condition.
- Guards must rotate freely on the yokes.

## SAFETY DECALS



PART NO.: 13-10022

**IMPORTANT**

- CHECK THAT GUARD MISSING DECAL ON STEEL TUBE UNDER INNER GUARD AND ROTATING DRIVELINE DECAL ON OUTER GUARD ARE FIRMLY AFFIXED, UNDAMAGED AND READABLE - IF NOT, REPLACE.
- GUARDS MUST ROTATE FREELY ON YOKES



PART NO.: 13-10021

FOR USE ON  
IMPLEMENT END  
ONLY



**ALL CLUTCHES MUST BE USED ON THE IMPLEMENT END ONLY**  
Yellow decal is provided on clutch.

## SAFETY MANUAL -

The Agricultural Driveline Manufacturers Association (ADMA) has printed a Safety Manual for owners and operators of agricultural machinery. Copies can be ordered from Weasler.

PART NO.: 56-15123

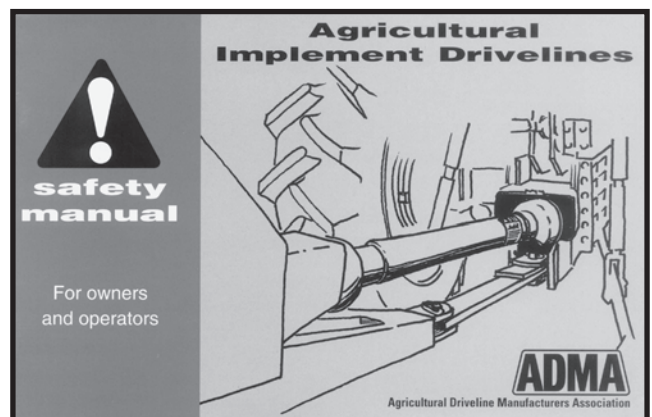

# EASY LOCK GUARD SYSTEM

## INSTRUCTIONS FOR REMOVAL AND INSTALLATION OF EASY LOCK GUARDS

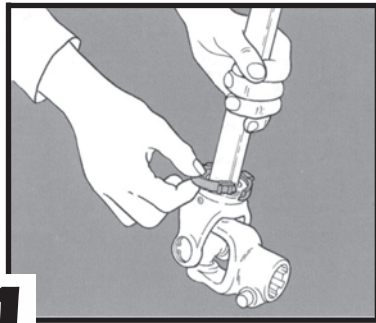
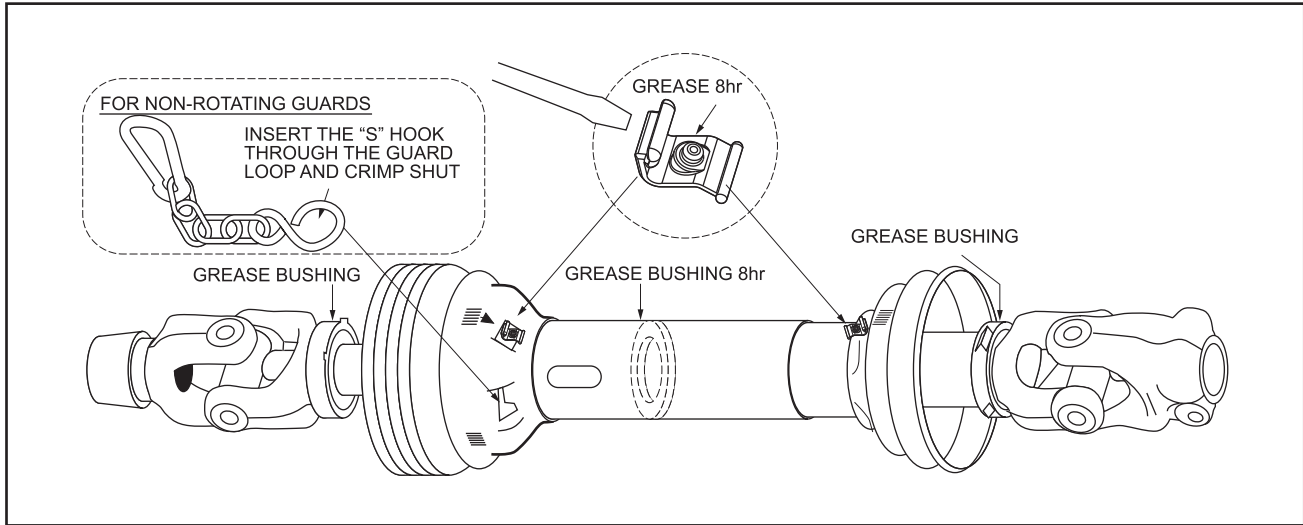

Clean and grease bearing raceway before the nylon bearing is placed in the groove. Grease any remaining nylon bearings in guard.

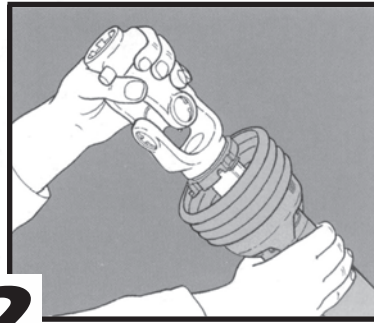

Slide guard half over driveline and insert nylon bearing tabs into the openings in the guard.

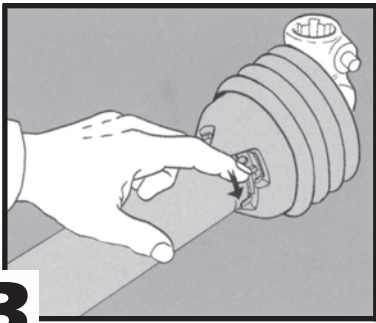

Turn the nylon bearing until it engages into the guard.

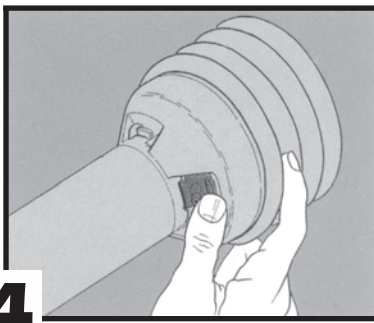

Push Easy Lock clip into position. The nylon bearing and guard are now secure. **GUARDS MUST ROTATE FREELY ON YOKES.**

**5** **TO REMOVE GUARD** - Use screwdriver to release Easy Lock clip. Turn the nylon bearings to disengage from the guard and remove guard.



# GREASING RECOMMENDATIONS

Be certain to follow greasing instructions as identified below:

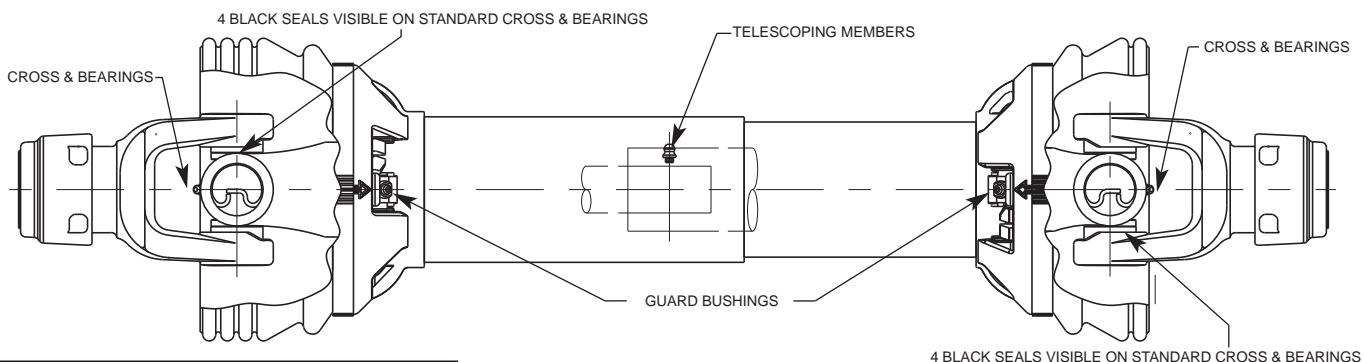

## TELESCOPING DRIVELINES

LUBRICATE ALL FITTINGS WITH A GOOD QUALITY LITHIUM SOAP COMPATIBLE E.P. GREASE MEETING THE N.L.G.I. #2 SPECIFICATIONS AND CONTAINING NO MORE THAN 1% MOLYBDENUM DISULFIDE.

AN E.P. GREASE MEETING THE N.L.G.I. #2 SPECIFICATIONS AND CONTAINING 3% MOLYBDENUM DISULFIDE MAY BE SUBSTITUTED IN THE TELESCOPING MEMBERS ONLY.

LOCATION	STANDARD INTERVAL	EXTENDED LUBE INTERVAL	LEVER ACTION PUMPS
CROSS & BEARINGS	*8 HRS.	50 HRS.	2-3
TELESCOPING MEMBERS	8 HRS.	50 HRS.	8-10
Ⓒ & NON-ROTATING GUARD BUSHINGS (1000 RPM MAX.)	8 HRS.	50 HRS.	2

ROTATING GUARD BUSHINGS SHOULD BE LUBRICATED UPON REPLACEMENT

\*CONSTANT ANGLE APPLICATIONS MAY REQUIRE A LUBE INTERVAL OF 4 HOURS

**CAUTION!! REPLACEMENT PARTS ARE NOT LUBRICATED**

REPLACEMENT PARTS MUST BE LUBRICATED AT TIME OF ASSEMBLY AND DURING USE PER THE LUBE RECOMMENDATIONS

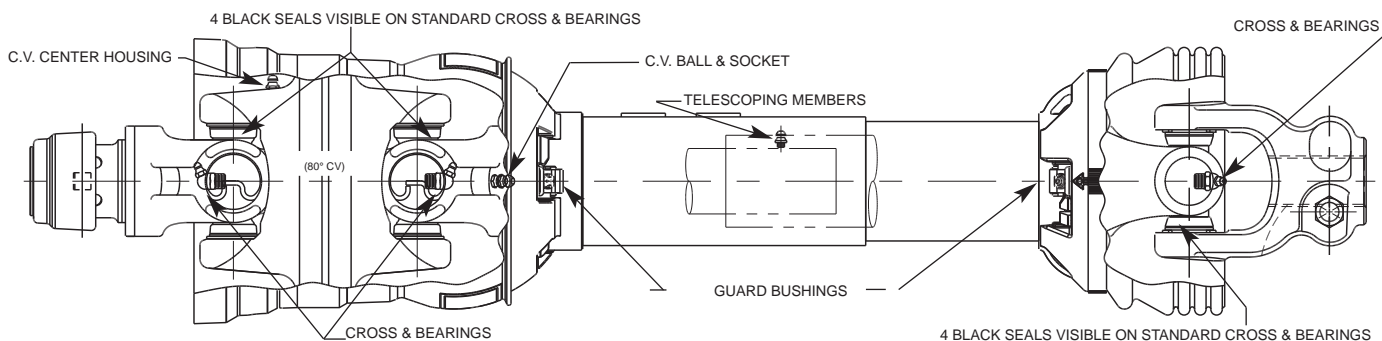

## 80° CONSTANT VELOCITY DRIVELINES

LUBRICATE ALL FITTINGS WITH A GOOD QUALITY LITHIUM SOAP COMPATIBLE E.P. GREASE MEETING THE N.L.G.I. #2 SPECIFICATIONS AND CONTAINING NO MORE THAN 1% MOLYBDENUM DISULFIDE.

AN E.P. GREASE MEETING THE N.L.G.I. #2 SPECIFICATIONS AND CONTAINING 3% MOLYBDENUM DISULFIDE MAY BE SUBSTITUTED IN THE TELESCOPING MEMBERS ONLY.

LOCATION	STANDARD INTERVAL	EXTENDED LUBE INTERVAL	LEVER ACTION PUMPS
CROSS & BEARINGS	*8 HRS.	50 HRS.	2-3
TELESCOPING MEMBERS	8 HRS.	50 HRS.	8-10
CV BALL & SOCKET	*8 HRS.	50 HRS.	4-6
CV CENTER HOUSING	24 HRS.	50 HRS.	12-15
Ⓒ & NON-ROTATING GUARD BUSHINGS (1000 RPM MAX.)	8 HRS.	50 HRS.	2

ROTATING GUARD BUSHINGS SHOULD BE LUBRICATED UPON REPLACEMENT

\*CONSTANT ANGLE APPLICATIONS MAY REQUIRE A LUBE INTERVAL OF 4 HOURS

**CAUTION!! REPLACEMENT PARTS ARE NOT LUBRICATED**

REPLACEMENT PARTS MUST BE LUBRICATED AT TIME OF ASSEMBLY AND DURING USE PER THE LUBE RECOMMENDATIONS

# GREASING RECOMMENDATIONS

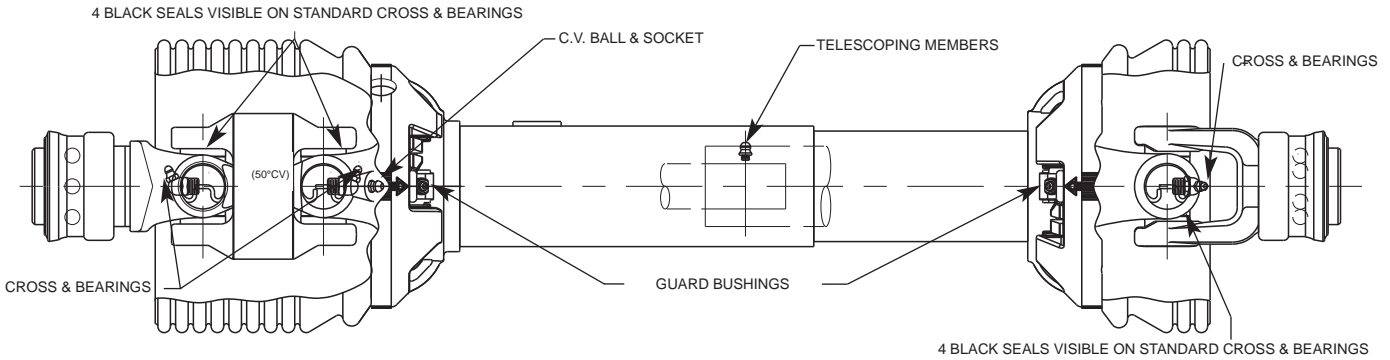

## 50° CONSTANT VELOCITY DRIVELINES

LUBRICATE ALL FITTINGS WITH A GOOD QUALITY LITHIUM SOAP COMPATIBLE E.P. GREASE MEETING THE N.L.G.I. #2 SPECIFICATIONS AND CONTAINING NO MORE THAN 1% MOLYBDENUM DISULFIDE.

AN E.P. GREASE MEETING THE N.L.G.I. #2 SPECIFICATIONS AND CONTAINING 3% MOLYBDENUM DISULFIDE MAY BE SUBSTITUTED IN THE TELESCOPING MEMBERS ONLY.

LOCATION	STANDARD INTERVAL	EXTENDED LUBE INTERVAL	LEVER ACTION PUMPS
CROSS & BEARINGS	*8 HRS.	50 HRS.	2-3
TELESCOPING MEMBERS	8 HRS.	50 HRS.	8-10
CV BALL & SOCKET	*8 HRS.	N/A	4-6
CE & NON-ROTATING GUARD BUSHINGS (1000 RPM MAX.)	8 HRS.	50 HRS.	2

ROTATING GUARD BUSHINGS SHOULD BE LUBRICATED UPON REPLACEMENT

\*CONSTANT ANGLE APPLICATIONS MAY REQUIRE A LUBE INTERVAL OF 4 HOURS

**CAUTION!! REPLACEMENT PARTS ARE NOT LUBRICATED**

REPLACEMENT PARTS MUST BE LUBRICATED AT TIME OF ASSEMBLY AND DURING USE PER THE LUBE RECOMMENDATIONS

## GREASING RECOMMENDATIONS FOR CROSS & BEARING KITS

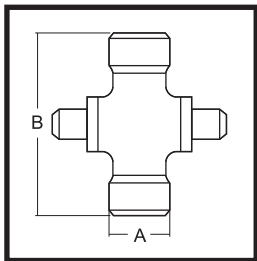

STANDARD CROSS & BEARING KITS (R-KITS) = 8 HOURS

EXTENDED LUBRICATION CROSS & BEARING KITS (E-KITS) = 50 - 250 HOURS

# DRIVELINE LENGTH ADJUSTMENT

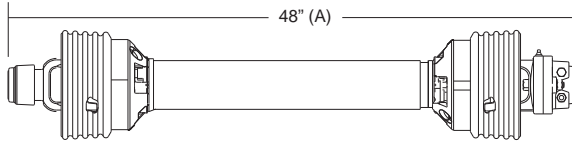

**Replacement Driveline**

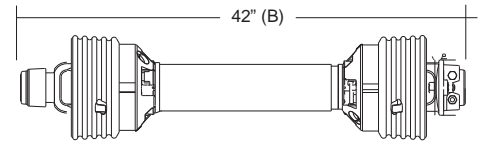

**Existing Driveline**

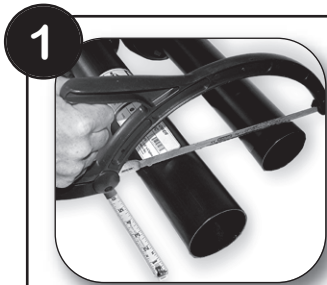

**1**

Remove guard from driveline. Separate driveline halves. Shorten guard halves (Pic. 1) and profile tube halves (Pic. 2) same as existing driveline halves or see example below.



**2**

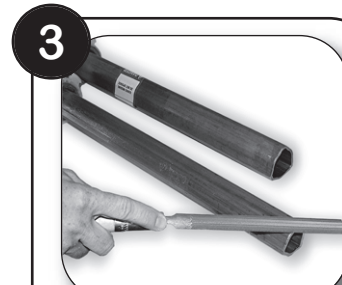

**3**

Round off all sharp edges and remove burrs.



**4**

Grease sliding profiles.

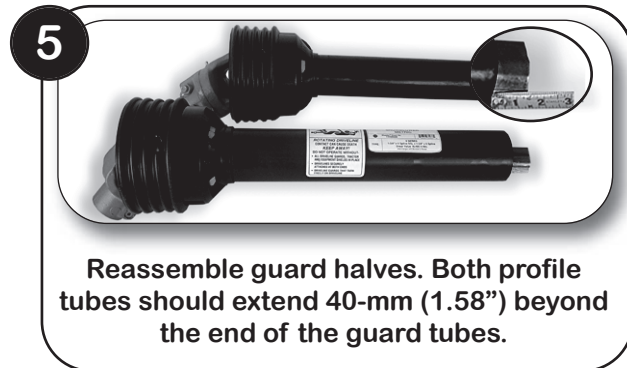

**5**

Reassemble guard halves. Both profile tubes should extend 40-mm (1.58") beyond the end of the guard tubes.



**6**

Reassemble driveline halves together making sure they slide (telescope) easily and ensure guards rotate freely on yokes.

**EXAMPLE:** If overall replacement driveline length dimension is 48" (See A), and your existing overall driveline length dimension is 42" (See B), the amount to shorten EACH driveline half would be 6".

Your driveline is now ready to reassemble and use.



## Aftermarket Product Guide



# Quick Reference

# CROSS REFERENCE CHART

## NORTH AMERICAN COMPONENTS

Weasler Cross & Brg. Kit Stock #	Weasler Aftmkt. U-Joint Series	Weasler U-Joint Series	APC/Wesco U-Joint Series	Chainbelt U-Joint Series	G&G U-Joint Series	Neapco U-Joint Series	Rockwell U-Joint Series	Spicer U-Joint Series
200-0100							1FR	
200-0600	6	L6W/6RW	6N 6R	–	6N	L600	L6N	–
200-0675						0675		
200-0700		W						
200-1000								1000
200-1200	12	12RW 12R	12N	R12N R31N/120	12N	1200	L12N	1140
200-1400	14	14R/GN 14NW	14N	R14N/140	14N	2000	L14N	1240
200-1875						1800		
200-2600						2600		1480
200-3500	35	35RW/35R DN/35NW	35N	R35N/350	35N	2200	35N	1340
200-4400	44	44R	44N	440	44R	44R	44R	1440
200-5500	55	L55/55NW 55R	–	–	55N	–	55N	–

QUICK REFERENCE SECTION

## METRIC COMPONENTS

Cross & Bearing R-Kit Stock #	Cross & Bearing E-Kit Stock No.	Interchanges With Bondioli & Pavesi Series	Interchanges With Walterscheid Series
200-6154	201-6154	1	N/A
200-6580	201-6580	5	N/A
200-6794	201-6794	7N	N/A
200-6806	201-6806	8	N/A
200-6908	201-6908	9	N/A
200-7004	201-7004	N/A	2600
200-7155	201-7155	N/A	2100
200-7676	201-7676	N/A	2400
200-7890	N/A	N/A	II
200-7989	201-7989	N/A	2500
200-8261	201-8261	2	2200
200-8370	201-8370	3	I
200-8474	201-8474	4	2300
200-8692	201-8692	6	220
200-8706	201-8706	7 (Old Series)	230
200-7276	201-7276	N/A	2280
200-7491	201-7491	N/A	2380
200-7694	201-7694	N/A	2480

# QUICK REFERENCE for Cross & Bearing Kits

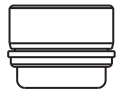

**1** Snap Ring located in the bushing (Internal)



**2** Snap Ring located in the yoke (External)

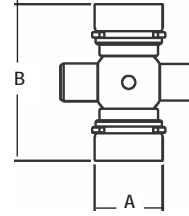
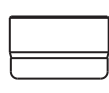

A - Bearing Diameter  
B - Cap to Cap Length

## NORTH AMERICAN SERIES

WEASLER (R) STOCK No.	WEASLER (E) STOCK No.	SERIES	(R) KIT RATED H/P @ 540 RPM	(E) KIT RATED H/P @ 540 RPM	(R) KIT RATED H/P @1000 RPM	(E) KIT RATED H/P @1000 RPM	(A) BEARING DIAMETER	(B) CAP TO CAP OVERALL LENGTH	SNAP RING TYPE	PAGE No.
200-0100	N/A	Rockwell 1FR	N/A	N/A	N/A	N/A	7/8" (.88)	2 15/16" (2.94)	2	84
200-0600	201-0600	6	14	19	21	29	31/32" (.97)	2 9/32" (2.28)	1	48
200-0675	N/A	0675	16	N/A	24	N/A	15/16" (.94)	2 5/16" (2.31)	1	80
200-0700	N/A	W	N/A	N/A	N/A	N/A	9/16" (.56)	1 1/2" (1.5)	Pin & Block	78
200-1000	N/A	1000	15	N/A	24	N/A	15/16" (.94)	2 23/64" (2.36)	1	81
200-1200	201-1200	12	19	26	29	40	1 1/16" (1.06)	2 1/2" (2.5)	1	53
200-1400	201-1400	14	28	38	44	58	1 1/8" (1.13)	2 5/8" (2.63)	2	58
200-1401	(Interchanges w/ Howse)	14	28	N/A	44	N/A	1 1/8" (1.13)	3 5/32" (3.16)	1	84
200-1875	N/A	1800	30	N/A	48	N/A	1" (1.0)	3 7/32" (3.22)	1	84
200-2600	N/A	2600	100	N/A	144	N/A	1 3/8" (1.38)	4 3/16" (4.19)	2	85
200-3500	201-3500	35	51	70	79	108	1 1/4" (1.25)	3 7/32" (3.22)	2	62
200-3501	(Interchanges w/ Howse)	35	51	N/A	79	N/A	1 1/4" (1.25)	3 7/32" (3.22)	1	84
200-4400	201-4400	44	77	103	119	158	1 5/16" (1.31)	4" (4.0)	1	68
200-5500	201-5500	55	106	137	164	211	1 17/32" (1.53)	4 5/16" (4.31)	2	73
N/A	201-7700	77	N/A	171	N/A	264	1 25/32" (1.78")	4 31/32" (4.96")	2	76

## ITALIAN SERIES

WEASLER (R) STOCK No.	WEASLER (E) STOCK No.	SERIES	(R) KIT RATED H/P @ 540 RPM	(E) KIT RATED H/P @ 540 RPM	(R) KIT RATED H/P @1000 RPM	(E) KIT RATED H/P @1000 RPM	BEARING DIAMETER	CAP TO CAP OVERALL LENGTH	SNAP RING TYPE	PAGE No.
200-6154	201-6154	1	15	19	23	29	22.0 mm (.8661)	54.0 mm (2.126)	2	92
200-8261	201-8261	2	21	25	33	38	23.8 mm (.937)	61.2 mm (2.409)	2	95
200-8370	201-8370	3	29	38	44	58	27.0 mm (1.063)	70.0 mm (2.756)	2	98
200-8474	201-8474	4	36	45	56	70	27.0 mm (1.063)	74.6 mm (2.937)	2	101
200-6580	201-6580	5	52	65	81	100	30.2 mm (1.189)	79.4 mm (3.134)	2	104
200-8692	201-8692	6	64	79	99	122	30.2 mm (1.189)	92.0 mm (3.661)	2	108
200-6794	201-6794	7N	79	94	122	145	34.9 mm (1.374)	94.0 mm (3.701)	2	110
200-6806	201-6806	8	100	120	154	185	34.9 mm (1.374)	106.5 mm (4.193)	2	113
200-6908	201-6908	9	120	151	185	232	41.0 mm (1.614)	108.0 mm (4.252)	2	116

## GERMAN SERIES

WEASLER (R) STOCK No.	WEASLER (E) STOCK No.	SERIES	(R) KIT RATED H/P @ 540 RPM	(E) KIT RATED H/P @ 540 RPM	(R) KIT RATED H/P @1000 RPM	(E) KIT RATED H/P @1000 RPM	BEARING DIAMETER	CAP TO CAP OVERALL LENGTH	SNAP RING TYPE	PAGE No.
200-7155	201-7155	2100	16	19	23	29	22.0 mm (.8661)	54.8 mm (2.158)	2	119
200-8261	201-8261	2200	21	25	33	38	23.8 mm (.937)	61.2 mm (2.409)	2	121
200-8370	201-8370	I	30	38	44	58	27.0 mm (1.063)	70.0 mm (2.756)	2	123
200-8474	201-8474	2300	37	45	56	70	27.0 mm (1.063)	74.6 mm (2.937)	2	125
200-8692	201-8692	220	64	79	99	122	30.2 mm (1.189)	92.0 mm (3.661)	2	128
200-7676	201-7676	2400	53	66	80	102	32.0 mm (1.259)	76.0 mm (2.992)	2	130
200-7989	201-7989	2500	80	94	124	144	36.0 mm (1.417)	88.8 mm (3.496)	2	133
200-7004	201-7004	2600	113	149	175	230	42.0 mm (1.654)	104.0 mm (4.095)	2	136

QUICK REFERENCE SECTION

# Constant Velocity Cross & Bearing Kits

## Quick Reference

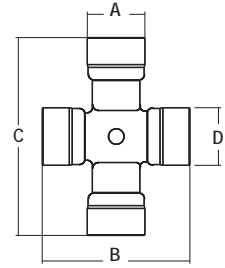

### UNEQUAL ARM C.V. KITS

#### 80° NORTH AMERICAN SERIES

WEASLER (R) STOCK No.	WEASLER (E) STOCK No.	CATEGORY	SERIES	(A) BEARING DIAMETER	(B) CAP TO CAP OVERALL LENGTH	(C) CAP TO CAP OVERALL LENGTH	(D) BEARING DIAMETER	PAGE No.
200-1430	201-1430	3	14	1 1/8" (1.13)	2 5/8" (2.63)	4 1/4" (4.25)	1 1/8" (1.13)	146
200-3540	201-3540	4	35	1 1/8" (1.13)	3 7/32" (3.22)	4 1/4" (4.25)	1 1/4" (1.25)	149
200-3545	201-3545	5	35/44	1 1/4" (1.25)	3 7/32" (3.22)	4 5/16" (4.31)	1 1/4" (1.25)	153
200-5556	N/A	6	55	1 5/16" (1.31)	3 23/32" (3.72)	4 5/16" (4.31)	1 17/32" (1.53)	158

#### 80° GERMAN SERIES

WEASLER (R) STOCK No.	WEASLER (E) STOCK No.	SERIES	(A) BEARING DIAMETER	(B) CAP TO CAP OVERALL LENGTH	(C) CAP TO CAP OVERALL LENGTH	(D) BEARING DIAMETER	PAGE No.
200-7491	201-7491	Metric 2380	27mm (1.063)	74.6mm (2.94)	91mm (3.583)	23.8mm (.737)	166
200-7694	201-7694	Metric 2480	32mm (1.259)	76mm (2.992)	94mm (3.701)	27mm (1.063)	168
200-7906	201-7906	Metric 2580	36mm (1.417)	88.8mm (3.496)	106mm (4.173)	32mm (1.259)	172

#### 80° EQUAL ARM WORLD WIDE C.V. KITS

Equal Arm C.V. Kits are not interchangeable with Unequal Arm C.V. Kits

WEASLER (R) STOCK No.	WEASLER (E) STOCK No.	ASAE CATEGORY	(A) BEARING DIAMETER	(B) CAP TO CAP OVERALL LENGTH
203-0310	204-0310	Cat. 3	27.0mm (1.07)	81.7mm (3.22)
203-8692	204-8692	Cat. 4	30.22mm (1.19)	92.0mm (3.63)
200-5800	201-5800	Cat. 5	30.22mm (1.19)	106.5mm (4.19)
203-6806	204-6806	Cat. 6	34.94mm (1.38)	106.5mm (4.20)

Bushing Lube  
Located in Cup

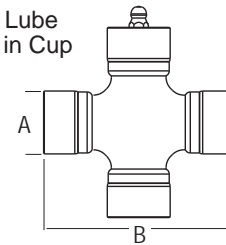

## NORTH AMERICAN SHAFTING & TUBING

### North American Shaft

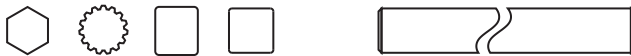

Stock Number	Size	Length
400-0012	3/4" Sq.	6'
400-0014	7/8" Sq.	6'
400-0015	1 5/16" Sq.	6'
400-0016	1" Sq.	6'
400-0019	1 3/16" Sq.	6'
400-0021	1 5/16" Sq.	6'
400-1214	3/4" x 7/8" Rect.	6'
400-1618	1" x 1 1/8" Rect.	6'
402-0014	7/8" Hex	6'
402-0016	1" Hex	6'
402-0018	1 1/8" Hex	6'
402-0020	1 1/4" Hex	6'
404-0019	1 3/16" Sq.	3'
404-0021	1 5/16" Sq.	3'
404-1214	3/4" x 7/8" Rect.	3'
404-1615H	1" x 15 Spl. (Induction Hardened)	3'
404-1618	1" x 1 1/8" Rect.	3'
404-2120	1 5/16" x 20 Spl. (Induction Hardened)	3'
404-2720	1 11/16" x 20 Spl. (Induction Hardened)	3'
404-7720	1 7/8" x 20 Spl. (Induction Hardened)	3'

### North American Tube



Stock Number	Size	Length
600-0012	1" Sq. Fits Shaft 3/4" Sq.	6'
600-0015	1 1/4" Sq. (.120 Wall) Fits Shaft 15/16"	6'
600-0016	1 1/4" Sq. (.109 Wall) Fits Shaft 1" Sq.	6'
600-0020	1 5/8" Sq. Fits Shaft 1.25" Sq.	6'
600-1618	1" x 1 x 1/8" Rect. O.D. - Fits Shaft 3/4" x 7/8"	6'
600-2022	1 1/4" x 1 3/8" Rect. O.D. - Fits Shaft 1" x 1 1/8"	6'
602-0600	1 1/2" Rd. (.065 Wall) O.D.	6'
602-1400	2" Rd. (.083 Wall) O.D.	6'
602-2600	2 3/4" Rd. (.109 Wall) O.D.	6'
602-3500	2 1/8" Rd. (.120 Wall) O.D.	6'
602-4400	2 1/2" Rd. (.120 Wall) O.D.	6'
604-0600	1 1/2" Rd. (.065 Wall) O.D.	3'
604-1400	2" Rd. (.083 Wall) O.D.	3'
604-1618	1" x 1 1/8" Rect. O.D. - Fits Shaft 3/4" x 7/8"	3'
604-2022	1 1/4" x 1 3/8" Rect. O.D. - Fits Shaft 1" x 1 1/8"	3'
604-3500	2 1/8" Rd. (.120 Wall) O.D.	3'
604-4400	2 1/2" Rd. (.120 Wall) O.D.	3'

# METRIC PROFILE SHAFTING & TUBING

## GERMAN-STYLE SHAFTING & TUBING

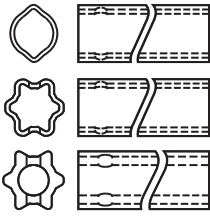

Lemon & Star Profile

## ITALIAN-STYLE SHAFTING & TUBING



Tri-Lobe Profile

SERIES	STOCK NO.	LENGTH		OUTSIDE DIAMETER		WALL THICKNESS		USE AS	PROFILE
		M	IN.	M	IN.	MM	IN.		
ByPy 1	400-6126	1.5	59.06	26.5	1.024	3.4	.138	Inner	Tri-Lobe
ByPy 1	404-6126	1	39.37	26.5	1.024	3.4	.138	Inner	Tri-Lobe
ByPy 1	600-6133	1.5	59.06	32.5	1.299	2.6	.102	Outer	Tri-Lobe
ByPy 1	604-6133	1	39.37	32.5	1.299	2.6	.102	Outer	Tri-Lobe
ByPy 1	604-6133	1	39.37	32.5	1.299	2.6	.102	Outer	Tri-Lobe
ByPy 2	400-6229	1.5	59.06	29	1.142	4.1	.134	Inner	Tri-Lobe
ByPy 2	404-6229	1	39.37	29	1.142	4.1	.134	Inner	Tri-Lobe
ByPy 2	600-6236	1.5	59.06	36	1.417	3.2	.134	Outer	Tri-Lobe
ByPy 2	604-6236	1	39.37	36	1.417	3.2	.134	Outer	Tri-Lobe
ByPy 3	600-6236	1.5	59.06	36	1.417	3.2	.134	Inner	Tri-Lobe
ByPy 3	604-6236	1	39.37	36	1.417	3.2	.134	Inner	Tri-Lobe
ByPy 3 & 4	600-6343	1.5	59.06	43.5	1.713	3.4	.138	Outer	Tri-Lobe
ByPy 3 & 4	604-6343	1	39.37	43.5	1.713	3.4	.138	Outer	Tri-Lobe
ByPy 4	400-6436	1.5	59.06	36	1.417	3.9	.157	Inner	Tri-Lobe
ByPy 4	404-6436	1	39.37	36	1.417	3.9	.157	Inner	Tri-Lobe
ByPy 5 & 6	400-6545	1.5	59.06	45	1.77	3.9	.150	Inner	Tri-Lobe
ByPy 5 & 6	404-6545	1	39.37	45	1.77	3.9	.150	Inner	Tri-Lobe
ByPy 5	600-6552	1.5	59.06	51.5	2.03	3	.120	Outer	Tri-Lobe
ByPy 5	604-6552	1	39.37	51.5	2.03	3	.120	Outer	Tri-Lobe
ByPy 6 & 7N	600-6654	1.5	59.06	54	2.13	4.5	.180	Outer	Tri-Lobe
ByPy 6 & 7N	604-6654	1	39.37	54	2.13	4.5	.180	Outer	Tri-Lobe
ByPy 7N	400-6745	1.5	59.06	45	1.77	5.4	.210	Inner	Tri-Lobe
ByPy 7N	404-6745	1	39.37	45	1.77	5.4	.210	Inner	Tri-Lobe
ByPy 8	600-6654	1.5	59.06	54	2.13	4.5	.180	Inner	Tri-Lobe
ByPy 8	604-6654	1	39.37	54	2.13	4.5	.180	Inner	Tri-Lobe
ByPy 8 & 9	600-6863	1.5	59.06	63	2.48	4.1	.161	Outer	Tri-Lobe
ByPy 8 & 9	604-6863	1	39.37	63	2.48	4.1	.161	Outer	Tri-Lobe
ByPy 9	400-6954	1.5	59.06	54	2.13	4.9	.190	Inner	Tri-Lobe
ByPy 9	404-6954	1	39.37	54	2.13	4.9	.190	Inner	Tri-Lobe
W/S 2100	400-7123	1.5	59.06	23.5	0.93	SOLID		Inner	Lemon
W/S 2100	404-7123	1	39.37	23.5	0.93			Inner	Lemon
W/S 2100	600-7130	1.5	59.06	30	1.19	2.9	.114	Outer	Lemon
W/S 2100	604-7130	1	39.37	30	1.19	2.9	.114	Outer	Lemon
W/S I, 2200 & 2300	400-7234	1.5	59.06	34.5	1.36	4	.160	Inner	Lemon
W/S I, 2200 & 2300	404-7234	1	39.37	34.5	1.36	4	.160	Inner	Lemon
W/S I, 2200 & 2300	600-7241	1.5	59.06	41	1.61	2.9	.114	Outer	Lemon
W/S I, 2200 & 2300	604-7241	1	39.37	41	1.61	2.9	.110	Outer	Lemon
W/S 2400 & 220/720	400-7539	1.5	59.06	39.5	1.56	4.5	.180	Inner	Lemon
W/S 2400 & 220/720	404-7539	1	39.37	39.5	1.56	4.5	.180	Inner	Lemon
W/S 2400 & 220/720	600-7548	1.5	59.06	48	1.89	3.8	.150	Outer	Lemon
W/S 2400 & 220/720	604-7548	1	39.37	48	1.89	3.8	.150	Outer	Lemon
W/S 2400 & 2500	400-7651	1.5	59.06	51	2.07	6	.240	Inner	Star
W/S 2400 & 2500	404-7651	1	39.37	51	2.07	6	.240	Inner	Star
W/S 2400 & 2500	600-7961	1.5	59.06	61	2.4	4.3	.170	Outer	Star
W/S 2400 & 2500	604-7961	1	39.37	61	2.4	4.3	.170	Outer	Star
W/S 2600	600-7961	1.5	59.06	61	2.4	4.3	.170	Inner	Star
W/S 2600	604-7961	1	39.37	61	2.4	4.3	.170	Inner	Star
W/S 2600	600-7071	1.5	59.06	71.5	2.81	4.9	.190	Outer	Star
W/S 2600	604-7071	1	39.37	71.5	2.81	4.9	.190	Outer	Star

QUICK REFERENCE SECTION



# UNIVERSAL JOINT REPLACEMENT

## TO DISASSEMBLE UNIVERSAL JOINT

1. Remove all snap rings

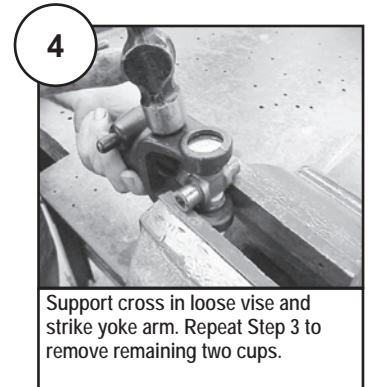
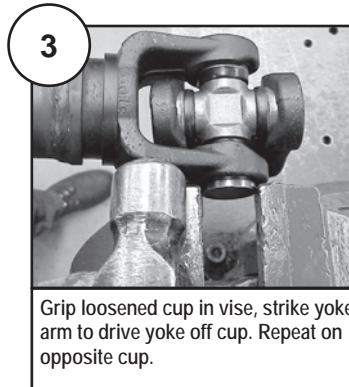
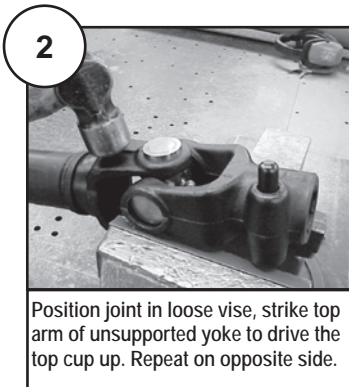
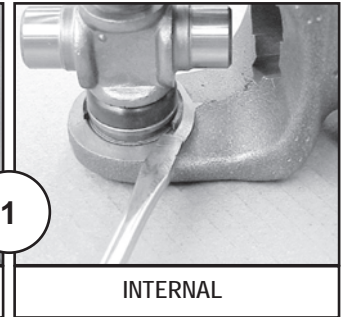
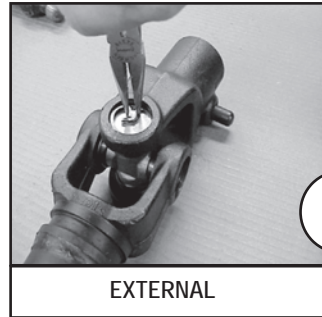

## TO REASSEMBLE UNIVERSAL JOINT

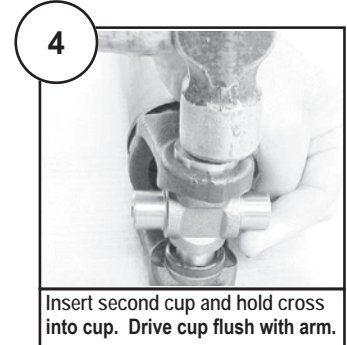
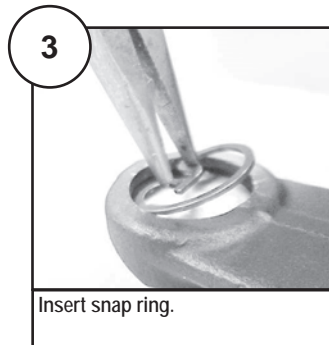
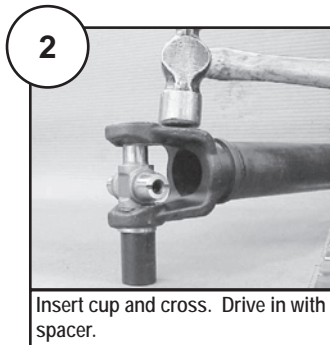

*\*Visually inspect the cross and bearing cap, needles and cross for any signs of cracks, wear, fatigue. Weasler highly recommends that upon re-assembly the cross and bearing be replaced and not re-used to ensure safety and maximum life.*

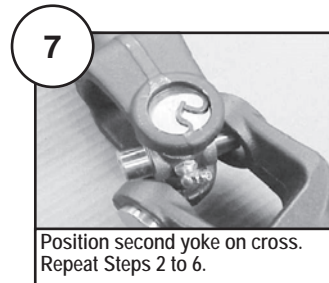
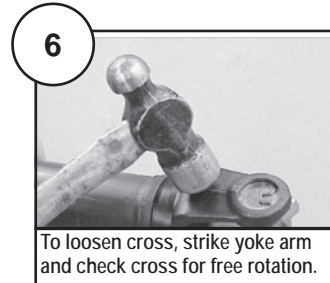
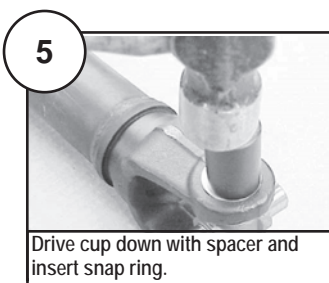

8

LUBRICATE ALL FITTINGS WITH A GOOD QUALITY LITHIUM SOAP COMPATIBLE E.P. GREASE MEETING THE N.L.G.I. #2 SPECIFICATIONS AND CONTAINING NO MORE THAN 1% MOLYBDENUM DISULFIDE.

QUICK REFERENCE SECTION

# EASY LOCK GUARDING SYSTEM



QUICK REFERENCE SECTION

## NORTH AMERICAN

SERIES	OLD GUARDS	OLD NYLON BEARING KITS	NEW GUARDS	NEW NYLON BEARING KITS
<b>6</b>	900-0648	920-0600/920-4P15	900-2548	921-0600
	900-0660	920-0600/920-4P15	900-2560	921-0600
<b>W</b>	900-0748	920-0141	900-2548	921-5170
<b>12</b>	900-1248	920-1200/920-4P16	900-2548	921-1200
	900-1260	920-1200/920-4P16	900-2560	921-1200
<b>14</b>	900-1248	920-1200/920-5071	900-2548	921-1200
	900-1260	920-1200/920-5071	900-2560	921-1200
<b>35</b>	900-3548	920-3500/920-5084	900-2548	921-1200
	900-3560	920-3500/920-5084	900-2560	921-1200
<b>44</b>	900-4448	920-4400	902-3548	921-4400
	900-4460	920-4400	902-3560	921-4400
<b>55</b>	900-4448	920-4400	902-3548	921-4400
	900-4460	920-4400	902-3560	921-4400

### PLEASE NOTE!

- Not all guard and nylon bearing systems are interchangeable. When purchasing shaft weld and tube weld yokes or guards, make certain there is a proper fit between nylon bearing raceway in yoke and guard. Make sure guard rotates freely on the yokes.
- The nylon bearings provided are the most popular in the replacement market. If the nylon bearing provided is not a proper fit, it is essential that the proper nylon bearing is identified and installed to insure proper performance and safety. To assist in ordering the proper nylon bearing, listed in this brochure are stock numbers and dimensions for nylon bearings.
- All Series North American guards are provided without nylon bearings. To help assure the proper set of nylon bearings are installed, one nylon bearing set will be exactly the same (nylon bearing raceway dimensions) as has always been provided in our aftermarket guards. The other set will be dimensioned to retrofit the Weasler OEM raceway. Assembly instructions included with these nylon bearing kits.
- **ALL GUARDS ARE PROVIDED WITHOUT NYLON BEARINGS - ORDER NYLON BEARINGS SEPARATELY**

# EASY LOCK GUARDING SYSTEM

## METRIC

QUICK REFERENCE SECTION

INTERCHANGES with SERIES	OLD GUARDS	OLD NYLON BEARING KITS	NEW GUARDS	NEW NYLON BEARING KITS
<b>BYPY 1</b>	900-8134	960-0101	900-2548	961-5029
	900-8148	960-0101	900-2548	961-5029
	900-8154	960-0101	900-2560	961-5029
<b>BYPY 2</b>	900-8234	960-0202	900-2548	961-2502
	900-8248	960-0202	900-2548	961-2502
	900-8254	960-0202	900-2560	961-2502
<b>BYPY 3 &amp; 4</b>	900-8234	960-0234	900-2548	961-2534
	900-8248	960-0234	900-2548	961-2534
	900-8254	960-0234	900-2560	961-2534
<b>BYPY 5</b>	900-8534	960-0305	902-3548	961-3505
	900-8548	960-0305	902-3548	961-3505
	900-8554	960-0305	902-3560	961-3505
<b>BYPY 6</b>	900-8634	960-0467	902-3548	961-3567
	900-8648	960-0467	902-3548	961-3567
	900-8254	960-0467	902-3560	961-3567
<b>BYPY 7</b>	900-8634	960-0467	902-3548	961-3567
	900-8648	960-0467	902-3548	961-3567
	900-8654	960-0467	902-3560	961-3567
<b>BYPY 8 &amp; 9</b>	900-6934	960-0489	900-4548	961-4589
	900-6948	960-0489	900-4548	961-4589
	900-6954	960-0489	900-4560	961-4589
<b>W/S 2100 (AW10)</b>	900-8134	960-0105	900-2548	961-5005
	900-8148	960-0105	900-2548	961-5005
	900-8154	960-0105	900-2560	961-5005
<b>W/S (AW20) &amp; W/S I (AWII)</b>	900-8234	960-0215	900-2548	961-0251
	900-8248	960-0215	900-2548	961-0251
	900-8254	960-0215	900-2560	961-0251
<b>W/S 2300 (AW21)</b>	900-8234	960-0215	900-2548	961-0251
	900-8248	960-0215	900-2548	961-0251
	900-8254	960-0215	900-2560	961-0251
<b>W/S 220 (AW22), W/S 2400 (AW35) &amp; W/S 2500 (AW36)</b>	900-8534	960-0325	902-3548	961-3525
	900-8548	960-0325	902-3548	961-3525
	900-8554	960-0325	902-3560	961-3525
<b>W/S 2600 (AW26)</b>	900-8634	960-0435	900-4548	961-4535
	900-8648	960-0435	900-4548	961-4535
	900-8654	960-0435	900-4560	961-4535

# EASY LOCK GUARDING SYSTEM

## NYLON BEARING REPAIR KITS

### TYPE A - FITS 250 GUARDS

#### NORTH AMERICAN SERIES

STOCK No.	SERIES	GUARD TYPE	DIM A INNER BRG. ID	DIM B INNER BRG. OD	DIM A OUTER BRG. ID	DIM B OUTER BRG. OD
921-0600	6	250	46.4-mm (1.83")	71.4-mm (2.81")	46.4-mm (1.83")	71.4-mm (2.81")
921-1200	12, 14 & 35	250	52.8-mm (2.08")	71.4-mm (2.81")	51.3-mm (2.02")	71.4-mm (2.81")
921-5170	W	250	41.8-mm (1.65")	71.4-mm (2.81")	41.8-mm (1.65")	71.4-mm (2.81")

#### METRIC SERIES

STOCK No.	INTERCHANGES W/SERIES	GUARD TYPE	DIM A INNER BRG. ID	DIM B INNER BRG. OD	DIM A OUTER BRG. ID	DIM B OUTER BRG. OD
961-5029	ByPy 1	250	34.5-mm (1.36")	71.4-mm (2.81")	40.4 -mm(1.59")	71.4-mm (2.81")
961-2502	ByPy 2	250	40.4-mm (1.59")	71.4-mm (2.81")	47.4-mm (1.87")	71.4-mm (2.81")
961-2534	ByPy 3 & 4	250	47.4-mm (1.87")	71.4-mm (2.81")	53.4-mm (2.10")	71.4-mm (2.81")
961-5005	W/S 2100	250	41.4-mm (1.63")	71.4-mm (2.81")	41.4-mm (1.63")	71.4-mm (2.81")
961-0251	W/S 2200, W/S I & W/S 2300	250	50.8-mm (2.00")	71.4-mm (2.81")	50.8-mm (2.00")	71.4-mm (2.81")

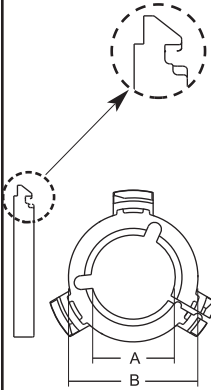

### TYPE B - FITS 350/450 GUARDS

#### NORTH AMERICAN SERIES

STOCK No.	SERIES	GUARD TYPE	DIM A INNER BRG. ID	DIM B INNER BRG. OD	DIM A OUTER BRG. ID	DIM B OUTER BRG. OD
921-4400	44 & 55	350	67.2-mm (2.65")	83.6-mm (3.29")	67.2-mm (2.65")	83.6-mm (3.29")

#### METRIC SERIES

STOCK No.	INTERCHANGES W/SERIES	GUARD TYPE	DIM A INNER BRG. ID	DIM B INNER BRG. OD	DIM A OUTER BRG. ID	DIM B OUTER BRG. OD
961-3505	ByPy 5	350	53.5-mm (2.11")	83.6-mm (3.29")	62.7-mm (2.47")	83.6-mm (3.29")
961-3567	ByPy 6 & 7	350	59.4-mm (2.34")	83.6-mm (3.29")	68.4-mm (2.69")	83.6-mm (3.29")
961-4589	ByPy 8 & 9	450	68.4-mm (2.69")	103-mm (4.06")	80.4-mm (3.17")	103-mm (4.06")
961-3525	W/S 220, W/S 2400, & W/S 2500	350	62.5-mm (2.46")	83-mm (3.27")	62.5-mm (2.46")	83-mm (3.27")
961-4535	W/S 2600	450	82.8-mm (3.26")	103-mm (4.05")	82.8-mm (3.26")	103-mm (4.05")

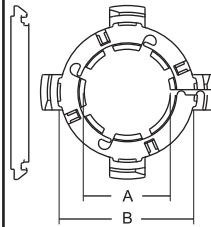

### TYPE C

#### PREVIOUS-STYLE METRIC NYLON BEARING KIT

INTERCHANGES W/ STOCK No.	SERIES	DIM A INNER BRG. ID	DIM B INNER BRG. OD	DIM A OUTER BRG. ID	DIM B OUTER BRG. OD
960-0101	ByPy 1	34.8-mm (1.37")	57-mm (2.24")	40.8-mm (1.61")	57-mm (2.24")
960-0202	ByPy 2	40.4-mm (1.59")	71.4-mm (2.81")	47.4-mm (1.87")	71.4-mm (2.81")
960-0234	ByPy 3 & 4	47.4-mm (1.87")	71.4-mm (2.81")	53.4-mm (2.10")	71.4-mm (2.81")
960-0305	ByPy 5	53.4-mm (2.10")	81.7-mm (3.22")	62.7-mm (2.47")	81.7-mm (3.22")
960-0467	ByPy 6 & 7	59.4-mm (2.34")	98.8-mm (3.89")	68.4-mm (2.69")	98.8-mm (3.89")
960-0489	ByPy 8 & 9	68.4-mm (2.69")	98.8-mm (3.89")	80.4-mm (3.17")	98.8-mm (3.89")
960-0105	W/S 2100	41.4-mm (1.63")	57-mm ((2.24")	41.4-mm (1.63")	57-mm (2.24")
960-0215	W/S 2200, AW11, & W/S 2300	50.8-mm (2.00")	71.4-mm (2.81")	50.8-mm (2.00")	71.4-mm (2.81")
960-0325	W/S 220, W/S 2400, & W/S 2500	62.7-mm (2.47")	81.7-mm (3.22)	62.7-mm (2.47")	81.7-mm (3.22")
960-0435	W/S 2600	82.8-mm (3.26")	98.8-mm (3.89")	82.8-mm (3.26")	98.8-mm (3.89")

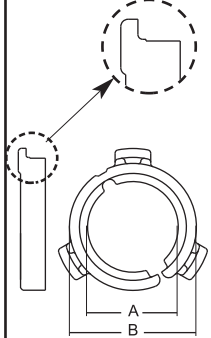

QUICK REFERENCE SECTION

# EASY LOCK GUARDING SYSTEM

## PREVIOUS-STYLE NORTH AMERICAN NYLON BEARING KIT

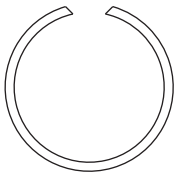
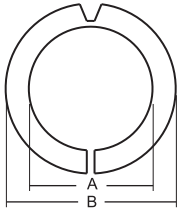
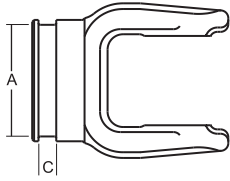

METAL RETAINING RING

STOCK NUMBER	DIM A		DIM B		DIM C	
	YOKE RACEWAY O.D.	NYLON BEARING I.D.	NYLON BEARING O.D.	YOKE RACEWAY WIDTH	NYLON BEARING WIDTH	
920-0017	2.15"	(2 5/32")	2.76"	(2 3/4")	.36"	(23/64")
920-0069	1.77"	(1 49/64")	2.76"	(2 3/4")	.36"	(23/64")
920-0085	2.02"	(2 1/64")	2.76"	(2 3/4")	.36"	(23/64")
920-0141	1.65"	(1 21/32")	2.76"	(2 3/4")	.36"	(23/64")
920-0165	2.15"	(2 5/32")	3.26"	(3 17/64")	.36"	(23/64")
920-0195	1.78"	(1 25/32")	2.52"	(2 33/64")	.37"	(3/8")
920-0259	2.03"	(2 1/32")	3.26"	(3 17/64")	.36"	(23/64")
920-0260	1.39"	(1 25/64")	2.77"	(2 49/64")	.36"	(23/64")
920-0600	1.83"	(1 53/64")	2.76"	(2 3/4")	.25"	(1/4")
920-1200	2.09"	(2 3/32")	2.77"	(2 49/64")	.32"	(21/64")
920-3500	2.08"	(2 5/64")	2.76"	(2 3/4")	.32"	(21/64")
920-4400	2.65"	(2 21/32")	3.26"	(3 17/64")	.36"	(23/64")
920-5071	2.02"	(2 1/64")	2.76"	(2 3/4")	.36"	(23/64")

(Kit includes nylon bearing and metal retaining ring)

QUICK REFERENCE SECTION

### 80° Constant Velocity Driveline

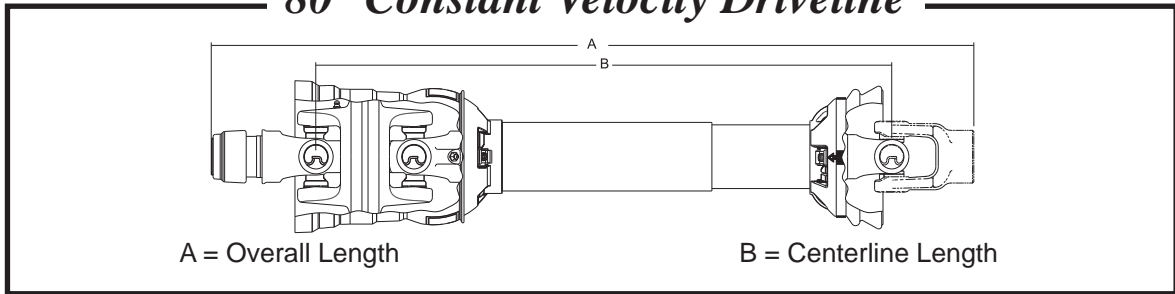

### Constant Velocity Driveline Replacement Chart

ASAE Category	Weasler Series	Replacement For
3	14	Bondioli & Pavesi 4 Series Walterscheid 2380 Series
4	35	Bondioli & Pavesi 5 Series
5	35/44	Bondioli & Pavesi 6 Series Walterscheid 2480 Series
6	55	Bondioli & Pavesi 8 Series Walterscheid 2580 Series & 2680 Series

The above chart lists the approximate size replacement for Constant Velocity Drivelines. These are not an exact interchange, and should be used as a general replacement guide only. NOTE: 35/44 refers to CV Series. When CV is assembled with 44 Series tube end driveline becomes a 44 Series. When CV is assembled with a 35 Series tube end driveline is a 35 Series.

# 1000 Series CROSS REFERENCE

NEAPCO PART NO.	WEASLER STOCK NO.	SPICER PART NO.	WEASLER STOCK NO.
-	802-1015	-	300-1000
-	802-1016	-	700-1000
-	10001-1036	-	10001-1044
1-0170	200-1000	-	802-1016
10-0322	10001-1014	-	802-1020
10-0333	10001-1012	-	10001-1034
10-0383	10001-1007	-	10001-1042
10-0411	801-1018	-	10001-1043
10-0412	804-1014	-	10001-1037
10-0413	10001-1045	-	10001-1035
10-0422	804-1012	-	10001-1036
10-0423	10001-1056	-	806-1013
10-0452	804-1016	-	10001-1061
10-0463 or 10-4453	10001-1049	-	806-1019
10-0473	800-1015	10-3-122X	10001-1015
10-0483	800-1016	10-3-163X	10001-1013
10-0493	10001-1051	10-3-183X	10001-1062
10-1532	10001-1034	10-3-22X	10001-1014
10-1557	10001-1037	10-3-33X	10001-1012
10-1574	806-1019	10-3-51X	812-1020
10-1702	10001-1039	10-3-83X	10001-1007
10-1703	10001-1040	10-4-110X	102-1006
10-1705	10001-1041	10-4-103	10001-1053
10-1707	10001-1043	10-4-11	801-1018
10-1708	10001-1044	10-4-113	10001-1052
10-1765	812-1020	10-4-12	804-1014
10-3122	10001-1015	10-4-123	10001-1054
10-3163	10001-1013	10-4-13 or 10-4-133	10001-1045
10-3183	10001-1062	10-4-153	800-1019
10-4123	10001-1055	10-4-163	800-1017
10-4139	102-1006	10-4-183	10001-1058
10-4143	10001-1053	10-4-193	10001-1055
10-4153	800-1019	10-4-22	804-1012
10-4163	800-1017	10-4-23	10001-1056
10-4173	800-1013	10-4-293	10001-1060
10-4183	10001-1058	10-4-373	800-1010
10-4193	10001-1054	10-4-43	800-1013
10-4293	10001-1060	10-4-443	10001-1059
10-4363	802-1020	10-4-453 or 10-4-253	10001-1049
10-4373	800-1010	10-4-481	801-1013
10-4443	10001-1059	10-4-52	804-1016
10-4473	10001-1052	10-4-53	10001-1057
10-4481	801-1013	10-4-573	10001-1051
10-4573 or 10-4493	10001-1033	10-4-63	10001-1048
10-4693	10001-1038	10-4-643	802-1015
10-4943	10001-1057	10-4-693	10001-1038
10-5113	10001-1048	10-4-703	10001-1040
10-5129	300-1000	10-4-713	10001-1039
10-5131	700-1000	10-4-723	10001-1041
10-5149	10001-1035	10-4-73	800-1015
10-5216	10001-1061	10-4-83	800-1016
10-5313	806-1013	10-4-93	10001-1033
10-5354	10001-1042	HM170	200-1000

**QUICK REFERENCE SECTION**

## Locking Device

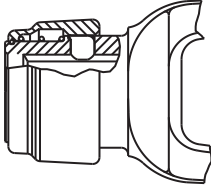

### Safety Slide Lock

An exclusive Weasler replacement component, the Safety Slide Lock\* yoke is locked in place by two hardened pawls with compound radii that conform to the groove in the shaft for full contact. The device is particularly applicable where there is appreciable end thrust.

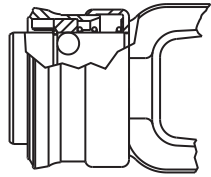

### Spring Lok

The collar is spring loaded for ease of installation and positive locking to tractor shaft.

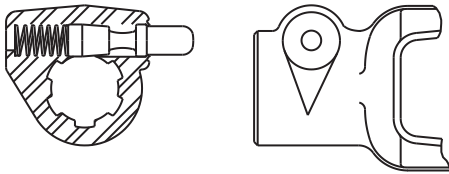

### Quick Disconnect

A smooth plunger eliminates sharp projections such as x-washers. Trails rather than leads rotation.

## Locking Device Repair Kit

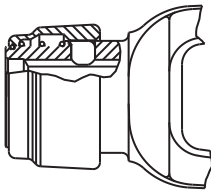

### \*Auto-Lok/Safety Slide Lock

Stock No. 13004000

Repair Kit for Weasler Auto-Lok and Safety Slide Lock  
6 Spline & 21 Spline

Stock No. 13004020

Repair Kit for Weasler Auto-Lok and Safety Slide Lock  
20 Spline

Stock No. 13004015

Repair Kit for  
1" x 15 Spline

\*This repair kit contains both balls & pawls. When repairing the "Safety Slide Lock" use the pawls only and discard the balls. When repairing the "Auto-Lok" use both the balls and the pawls.

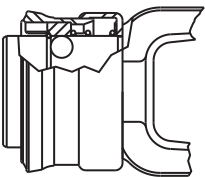

### Spring Lok

Stock No. 13003100

Repair Kit for Weasler Spring-Lok  
6 Spline & 21 Spline

Stock No. 13003115

1" x 15 Spline

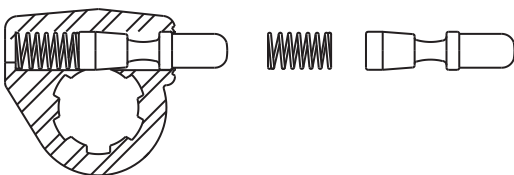

### Quick Disconnect

Stock No. 13002006

Repair Kit for Weasler  
and Rockwell 6 Spline

Stock No. 13002806

Repair Kit for 1 3/4" x 6 Spl.

Stock No. 13002021

Weasler 21 Spline and  
Hex Quick Disconnect

Stock No. 13002020

Weasler 20 Spline

## CONVERSION TABLE

1 inch	=	25.4 mm	1 HP	=	0.746 kW
1 mm	=	0.0394 inch	1 kW	=	1.341 HP
1 lb	=	4.44 N	1 Kg	=	2.305 lb
1 N	=	0.225 lb	1 lb	=	0.454 Kg
1 in•lb	=	0.113 Nm	1 ft•lb	=	1.356 Nm
1 Nm	=	0.738 ft•lb	1 M	=	1000 mm
1 Nm	=	8.85 in•lb	1 ft	=	12 inches
			1 kW	=	1000 Watts

## STANDARD UNIT CONVERSION

Power (HP)	=	$\frac{\text{Torque (in}\cdot\text{lb)} \times \text{Shaft Speed (RPM)}}{63,000}$
Torque (in•lb)	=	$\frac{\text{Power (HP)} \times 63,000}{\text{Shaft Speed (RPM)}}$

## METRIC UNIT CONVERSION

Power (kW)	=	$\frac{\text{Torque (Nm)} \times \text{Shaft Speed (RPM)}}{0.00955}$
Torque (Nm)	=	$\frac{\text{Power (kW)} \times 0.00955}{\text{Shaft Speed (RPM)}}$



# *NOTES*

**QUICK REFERENCE  
SECTION**



## Aftermarket Product Guide



# Replacement Drivelines

# SMOOTH. RELIABLE. SAFE.

Transfer the right amount of power when and where you need it with Weasler's drive shaft lines.

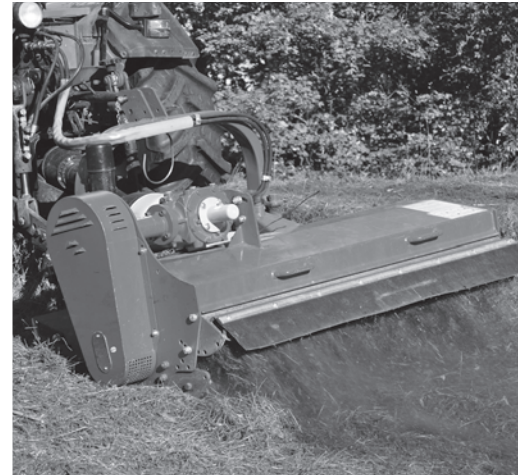
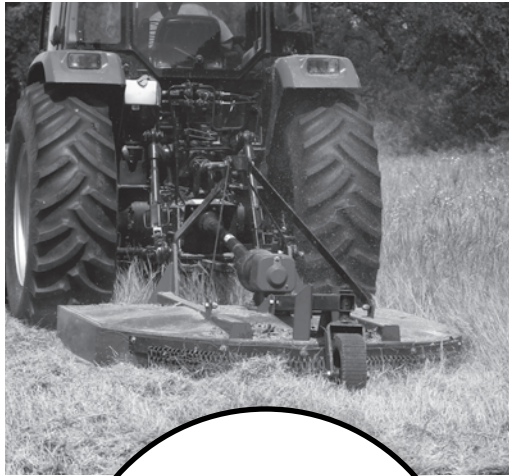

## THE STANDARD DRIVE SHAFT

When you have occasional equipment projects that only require up to 80hp, choose the Standard Drive Shaft. Perfect for applications such as rotary cutters, fertilizer spreaders, tillers and more, the Standard PTO is the perfect ready-to-install solution.

Part#	Application	Series
14006127ST	Fertilizer Spreader	1 Series
14006340ST	Finish Mower / Rotary Cutter	3 Series
14006430ST	Finishing Mower and Rotary Cutter	4 Series
14006432ST	4-ft. Rotary Cutter	4 Series
14006437ST	5-ft. Rotary Cutter	4 Series
14006442ST	6-ft. Rotary Cutter	4 Series
14006448ST	All Purpose Driveline	4 Series
14006453ST	Post Hole Digger	4 Series
14006542ST	6-ft. Lift Cutter HD	5 Series
14006546ST	Heavy Duty Rotary Cutter	5 Series
14006657ST	All Purpose Driveline	6 Series
14106436ST	Pull-Type Cutter/Tiller	4 Series

REPLACEMENT  
DRIVELINES



**Weasler**<sup>®</sup>

All Weasler PTO drive shafts are made up of quality components and are designed to meet the regional ASABE and CEN standards in which they will be used. To learn more about what Weasler drive shafts can do for your next project, **Call 262.338.2161 or visit Weasler.com.**

# Standard Product, Quality Components

Even low horse power applications require a seamless transfer of power between a tractor and its attached machinery. As a global leader in mechanical power transmission, Weasler's focus on quality components gives you the best drive train system for your essential drive train applications.

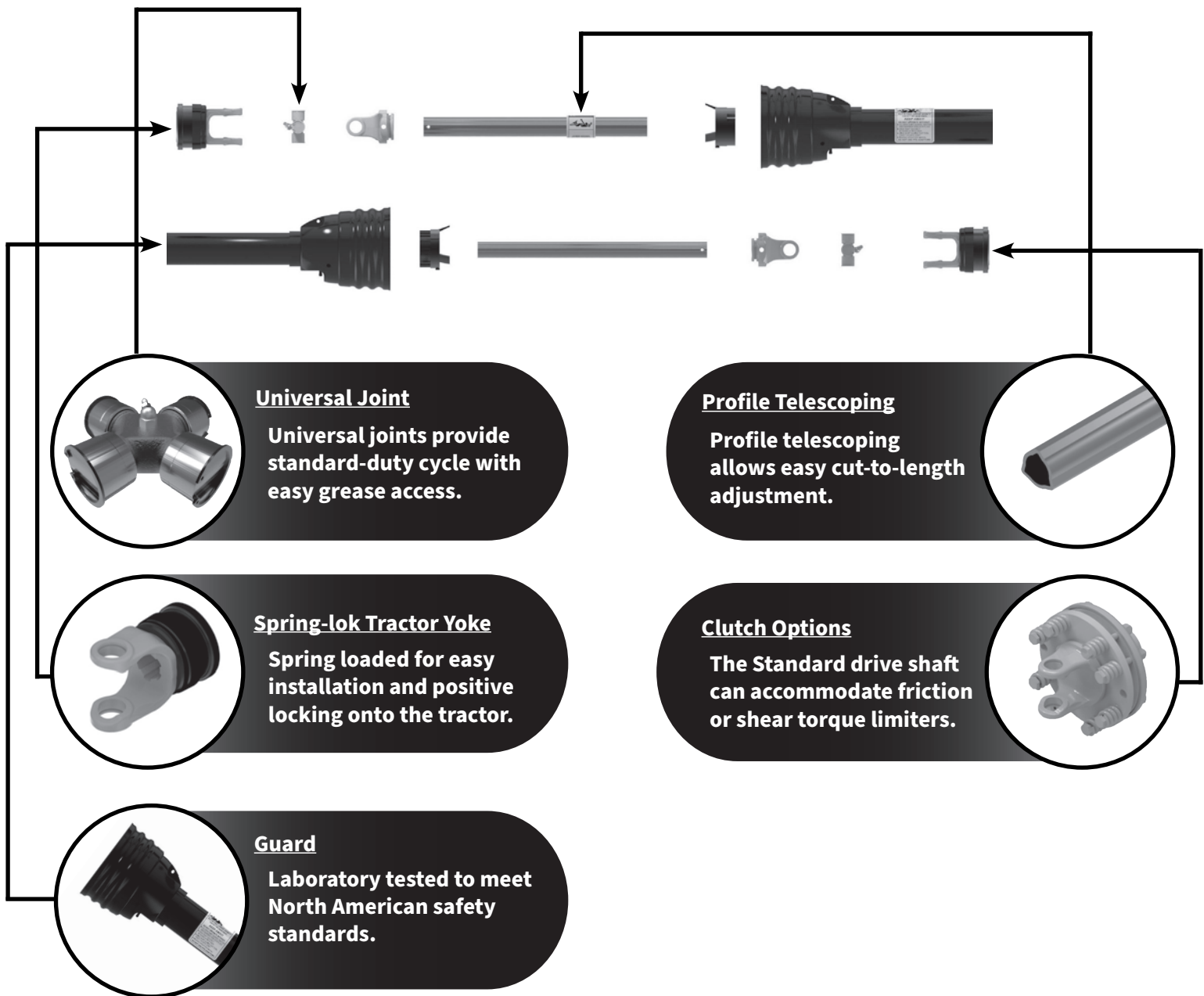

With our well-thought through components, our Standard product is designed to deliver a drive shaft that pairs perfectly with lower powered drive train applications. If you would like to know more about our products or services, contact your local Weasler representative today.



# Weasler®

## GENUINE WEASLER - DESIGNED TO PERFORM

▪ Choice of the OEM's ▪ Leading provider to the Aftermarket! ▪

### **TORQMASTER OVERRUNNING FRICTION CLUTCH**

- Visual Wear Indicator shows clutch disc life
- Unique spring maintains torque level throughout life of friction disc - no adjustment needed
- Housing designed to efficiently dissipate heat and extend life



### **50° CV JOINT**

- Minimal vibration at high turn angles
- Hardened ball and socket provides long life
- Articulated guard system provides full coverage at maximum angle
- Easy to grease with the guard system in position

### **SPLINE SHAFTING & SLIP SLEEVE**

- Smooth drive shaft operation due to close fit between shaft and broached slip sleeve
- Increased durability with heat treated telescoping members
- Lubrication to 360° of shaft surface
- Multiple contact points reduce wear by distributing the load



### **EASY LOCK GUARD SYSTEM**

- User friendly - easy assembly
- Simple tool needed to unlock safety shield
- No tool needed to lock safety shield



### **E-KITS**

- Extended lubrication cycle of 50 to 250 hours
- Easier grease access through the guard, no need to remove the guard
- High temperature triple lipped seal keeps grease in and contaminants out



REPLACEMENT  
DRIVELINES

## COMPLETE DOUBLE 50° CV DRIVELINE - INCLUDING FREE MOTION CLUTCH

▪ 1-3/8" x 21 Spline Friction Clutch with Double Clamp Yoke x 1 3/8" 21 Spline CV Double Clamp Yoke ▪

### **PART No.: 14605578**

▪ 78" OVERALL COMPRESSED LENGTH ▪

Fits Standard Tongue CNH Models: 210; DC102; DC103; H7230; H7330; 1411; 1412

### **PART No.: 14605589**

▪ 89" OVERALL COMPRESSED LENGTH ▪

Fits Swivel Tongue CNH Models: 210; DC102; DC103; H7230; H7330

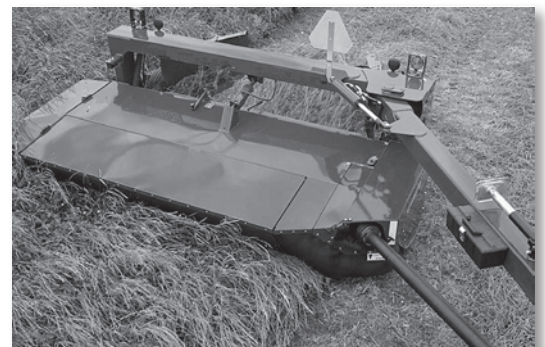

## DOUBLE CV MOWER CONDITIONER

Providing  
Better Solutions...

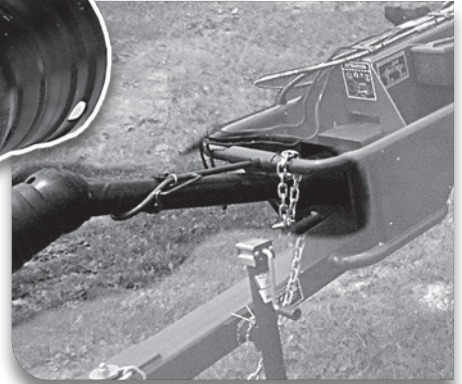

- **LONGER LIFE:**
- **PATENTED:**
- **E-KITS:**
- **EQUAL ARM CV:**
- **NO MODIFICATION:**
- **MULTIPLE MODELS:**
- **REDUCED INVENTORY:**

**Hardening Spline Shafting**  
**Easy Lock Guarding**  
**More durability and longer grease intervals**  
**Compact design - easier to handle**  
**Ready to run**

- No need to cut-to-length (unlike other Aftermarket options)
- Design optimizes compressed and extended lengths

**3 drivelines cover 5 brands and 7 models**

**CASE IH**

**CNH**

**HESSTON**

**MASSEY**

**NEW IDEA**

### DIRECT REPLACEMENT DOUBLE CV DRIVELINES

STOCK#	INTERCHANGES WITH	MODEL NO.
14656849	1 3/8" - 21 Spl. x 1 1/2" Rd. w- 3/8" K-Way	
	AGCO HESSTON	1340, 1345
	CASE IH	8312
	MASSEY FERGUSON	PDT 12
	NEW IDEA	5512
14656853	1 3/8" - 21 Sp. x 1 1/2" - 23 Spl.	
	CASE IH	DC132
	CNH	1431
14756853	1 3/4" - 20 Spl. x 1 1/2" - 23 Spl.	
	CASE IH	DC132
	CNH	1431

### \* DRIVELINE TRACTOR CV HALF ASSEMBLY

STOCK#	INTERCHANGES WITH	MODEL NO.
83-14656849	1 3/8" x 21 Spl	
	AGCO HESSTON	1340, 1345
	CASE IH	8312
	MASSEY FERGUSON	PDT 12
	NEW IDEA	5512
83-14656853	1 3/8" x 21 Spl	
	CASE IH	DC132
	CNH	1431
83-14756853	1 3/4" x 20 Spl	
	CASE IH	DC132
	CNH	1431

### \* DRIVELINE MACHINE CV HALF ASSEMBLY

82-14656849	1 1/2" Round with 3/8" K-way	
	AGCO HESSTON	1340, 1345
	CASE IH	8312
	MASSEY FERGUSON	PDT 12
	NEW IDEA	5512
82-14656853	1 1/2" - 23 Spl.	
	CASE IH	DC132
	CNH	1431

\*Complete shield is provided when ordering half drivelines



**Weasler®**

# METRIC TRI-LOBE (ITALIAN STYLE)



- Weasler CV's now equipped with Italian-style tri-lobe tubing.
- Very significant field population of machines equipped with Italian CVs.
- **Weasler CV** has fully enclosed center housing with patented ball and socket system = **higher performance and longer life.**
- Light weight and compact CV design for handling ease - and has easy access for all greasing locations.
- EasyOff / Easy On - CV carries patented and user-friendly **Easy Lock Guard System.**

## MIX AND MATCH FOR COMPLETE OFFERING

- Round Balers •
- Flex Wing Mowers •
- Hay Rakes •
- Tedders •
- Sprayers •

### CV TRACTOR HALF ASSEMBLY

Interchanges with

**Bondoli & Pavesi**

(APPROXIMATE 60" OVERALL COMPRESSED LENGTH)

### TUBE HALF ASSEMBLY

REPLACEMENT DRIVELINES

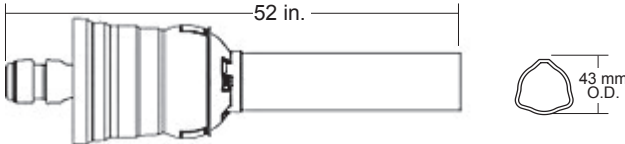

WEI Part #	ByPy Series	Tractor Yoke
93-14586460	4	1-3/8" 6 Spl.
93-14686460	4	1-3/8" 21 Spl.

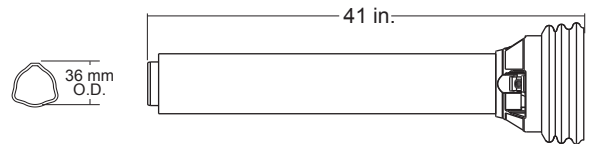

WEI Part #
92-14586460

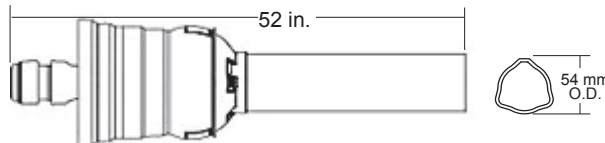

WEI Part #	ByPy Series	Tractor Yoke
93-14586660	6	1-3/8" 6 Spl.
93-14686660	6	1-3/8" 21 Spl.
93-14786660	6	1-3/4" 20 Spl.

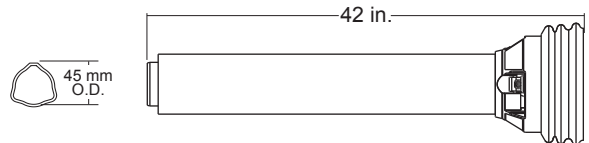

WEI Part #
92-14586660

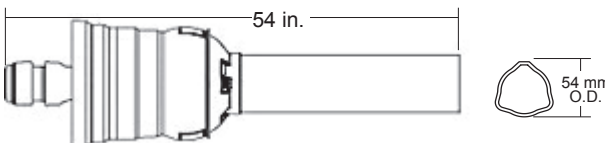

WEI Part #	ByPy Series	Tractor Yoke
93-14586860	8	1-3/8" 6 Spl.
93-14686860	8	1-3/8" 21 Spl.
93-14786860	8	1-3/4" 20 Spl.

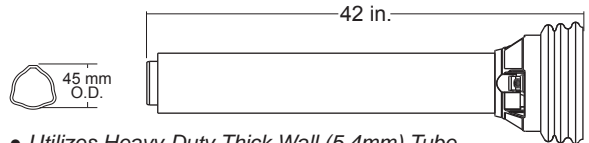

• Utilizes Heavy-Duty Thick Wall (5.4mm) Tube

WEI Part #
92-14586860

**NOTE:** Order **Implement Yoke and Cross & Bearing Kit** as required. *Cut-to-Length CV drivelines may need to be adjusted for the intended application. See Page 6 for Driveline Length Adjustment instructions.*

# “READY-TO-GO” ROUND BALER CV REPLACEMENTS...

## Genuine Weasler

- choice of the OEM's
- leading provider to the Aftermarket !



### • CV TRACTOR TUBE HALF ASSEMBLY •

Interchanges with:

**1-3/8" x 6 Spline Tractor Yoke - 540 RPM**

**Part #: 92-14558659:**

DEERE® MODELS: 447, 449, 457, 458, 458S, 459, 467, 468, 469, 547, 557, 558, 559, 567, 568, 569

**1-3/8" x 21 Spline Tractor Yoke - 1000 RPM**

**Part #: 92-14658659:**

DEERE® MODELS: 447, 457, 468, 468S, 469, 547, 557, 568, 569

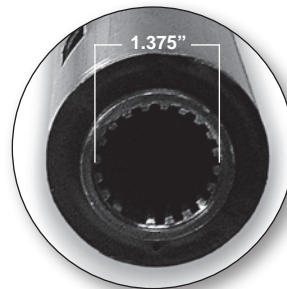

**CAT 4**  
Fits 1 5/16" Spline Shaft

REPLACEMENT  
DRIVELINES

Interchanges with:

**1-3/8" x 6 Spline Tractor Yoke - 540 RPM**

**Part #: 92-14505859:**

DEERE® MODELS: 447, 448, 457, 467, 547, 557, 567

**1-3/8" x 21 Spline Tractor Yoke - 1000 RPM**

**Part #: 92-14605859:**

DEERE® MODELS: 467, 468, 468S, 567, 568

**CAT 5**  
Fits 1 11/16" Spline Shaft

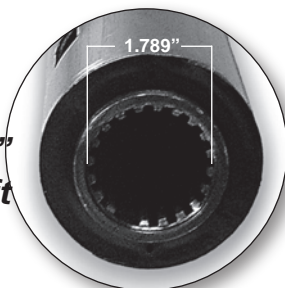

**NOTE:** Certain models (highlighted above) were originally equipped to accept either the large (1-11/16") spline or the smaller (1-5/16") spline. Please verify correct spline configuration before ordering.





## CONSTANT VELOCITY DRIVELINES...continued

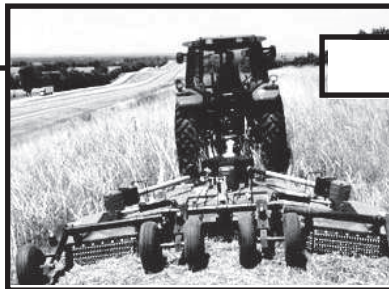
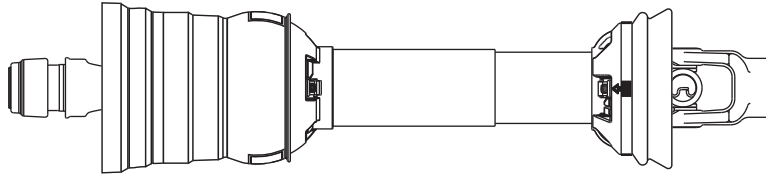

### • FLEX WING MOWERS •

Interchange with:

### • BUSH HOG® Model No.: 2415, 2515, 2615, 2720 & 3615

ALSO FITS OTHER COMPETITIVE MODELS

**NORTH AMERICAN**

### COMPLETE DRIVELINE ASSEMBLY

**METRIC**

STOCK #	TRACTOR YOKE	CLAMP YOKE	CATEGORY
14566855	1 3/8" x 6 Spl.	1 3/4" x 20 Spl.	6
14666855	1 3/8" x 21 Spl.	1 3/4" x 20 Spl.	6
14766855	1 3/4" x 20 Spl.	1 3/4" x 20 Spl.	6

STOCK #	TRACTOR YOKE	CLAMP YOKE	CATEGORY
14516855	1 3/8" x 6 Spl.	1 3/4" x 20 Spl.	6
14616855	1 3/8" x 21 Spl.	1 3/4" x 20 Spl.	6
14716855	1 3/4" x 20 Spl.	1 3/4" x 20 Spl.	6

(OVERALL COMPRESSED LENGTH - 55")

### DRIVELINE TRACTOR HALF ASSEMBLY

STOCK #	TRACTOR YOKE	CATEGORY
93-14556855	1 3/8" x 6 Spl.	6
93-14656855	1 3/8" x 21 Spl.	6
93-14756855	1 3/4" x 20 Spl.	6

STOCK #	TRACTOR YOKE	CATEGORY
93-14516855	1 3/8" x 6 Spl.	6
93-14616855	1 3/8" x 21 Spl.	6
93-14716855	1 3/4" x 20 Spl.	6

### DRIVELINE MACHINE HALF ASSEMBLY

STOCK #	MACHINE (CLAMP) YOKE	CATEGORY
92-14515555	1 3/4" x 20 Spl.	6

STOCK #	MACHINE (CLAMP) YOKE	CATEGORY
92-14516855	1 3/4" x 20 Spl.	6

REPLACEMENT DRIVELINES

## CONSTANT VELOCITY DRIVELINES...continued

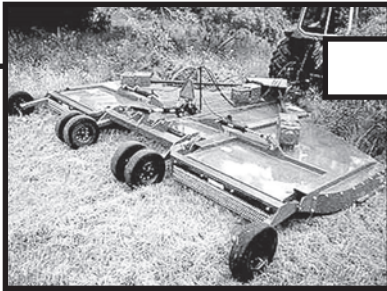
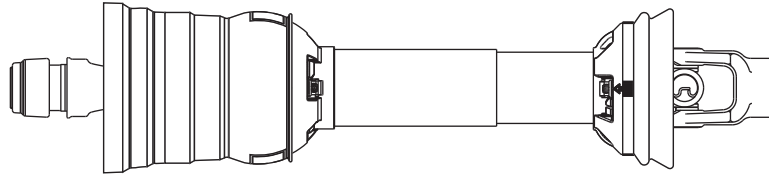

### • FLEX WING MOWERS •

Interchange with:

• **RHINO® Model No.: SR-15, SE-15**

ALSO FITS OTHER  
COMPETITIVE MODELS

NORTH AMERICAN				<b>COMPLETE DRIVELINE ASSEMBLY</b>				METRIC			
STOCK #	TRACTOR YOKE	CLAMP YOKE	CATEGORY	STOCK #	TRACTOR YOKE	CLAMP YOKE	CATEGORY	STOCK #	TRACTOR YOKE	CLAMP YOKE	CATEGORY
14556851	1 3/8" x 6 Spl.	1 3/4" x 20 Spl.	6	14506851	1 3/8" x 6 Spl.	1 3/4" x 20 Spl.	6	14506851	1 3/8" x 6 Spl.	1 3/4" x 20 Spl.	6
14656851	1 3/8" x 21 Spl.	1 3/4" x 20 Spl.	6	14606851	1 3/8" x 21 Spl.	1 3/4" x 20 Spl.	6	14606851	1 3/8" x 21 Spl.	1 3/4" x 20 Spl.	6
14756851	1 3/4" x 20 Spl.	1 3/4" x 20 Spl.	6	14706851	1 3/4" x 20 Spl.	1 3/4" x 20 Spl.	6	14706851	1 3/4" x 20 Spl.	1 3/4" x 20 Spl.	6
(OVERALL COMPRESSED LENGTH - 51")											
				<b>DRIVELINE TRACTOR HALF ASSEMBLY</b>							
STOCK #	TRACTOR YOKE	CATEGORY		STOCK #	TRACTOR YOKE	CATEGORY		STOCK #	TRACTOR YOKE	CATEGORY	
19556800	1 3/8" x 6 Spl.	6		93-14506851	1 3/8" x 6 Spl.	6		93-14506851	1 3/8" x 6 Spl.	6	
19656800	1 3/8" x 21 Spl.	6		93-14606851	1 3/8" x 21 Spl.	6		93-14606851	1 3/8" x 21 Spl.	6	
19756800	1 3/4" x 20 Spl.	6		93-14706851	1 3/4" x 20 Spl.	6		93-14706851	1 3/4" x 20 Spl.	6	
				<b>DRIVELINE MACHINE HALF ASSEMBLY</b>							
STOCK #	MACHINE (CLAMP) YOKE	CATEGORY		STOCK #	MACHINE (CLAMP) YOKE	CATEGORY		STOCK #	MACHINE (CLAMP) YOKE	CATEGORY	
92-14505551	1 3/4" x 20 Spl.	6		92-14506851	1 3/4" x 20 Spl.	6		92-14506851	1 3/4" x 20 Spl.	6	

REPLACEMENT  
DRIVELINES



**CONSTANT VELOCITY DRIVELINES...continued**

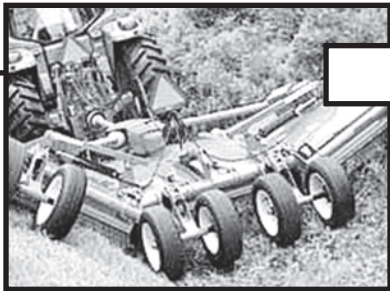
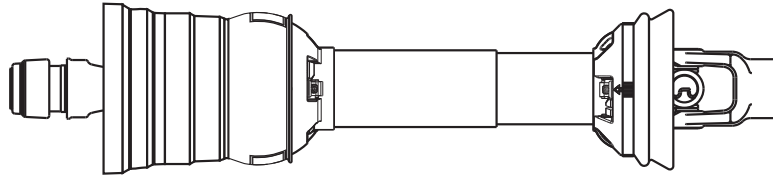

**• FLEX WING MOWERS •**

Interchange with:

**• DEERE® Model No.: 1517, 1518, 2018**

ALSO FITS OTHER COMPETITIVE MODELS

**NORTH AMERICAN**

**COMPLETE DRIVELINE ASSEMBLY**

**METRIC**

STOCK #	TRACTOR YOKE	CLAMP YOKE	CATEGORY
14566855	1 3/8" x 6 Spl.	1 3/4" x 20 Spl.	6
14666855	1 3/8" x 21 Spl.	1 3/4" x 20 Spl.	6
14766855	1 3/4" x 20 Spl.	1 3/4" x 20 Spl.	6

STOCK #	TRACTOR YOKE	CLAMP YOKE	CATEGORY
14516855	1 3/8" x 6 Spl.	1 3/4" x 20 Spl.	6
14616855	1 3/8" x 21 Spl.	1 3/4" x 20 Spl.	6
14716855	1 3/4" x 20 Spl.	1 3/4" x 20 Spl.	6

(OVERALL COMPRESSED LENGTH - 55")

**DRIVELINE TRACTOR HALF ASSEMBLY**

STOCK #	TRACTOR YOKE	CATEGORY
93-14556855	1 3/8" x 6 Spl.	6
93-14656855	1 3/8" x 21 Spl.	6
93-14756855	1 3/4" x 20 Spl.	6

STOCK #	TRACTOR YOKE	CATEGORY
93-14516855	1 3/8" x 6 Spl.	6
93-14616855	1 3/8" x 21 Spl.	6
93-14716855	1 3/4" x 20 Spl.	6

**DRIVELINE MACHINE HALF ASSEMBLY**

STOCK #	MACHINE (CLAMP) YOKE	CATEGORY
92-14515555	1 3/4" x 20 Spl.	6

STOCK #	MACHINE (CLAMP) YOKE	CATEGORY
92-14516855	1 3/4" x 20 Spl.	6

**REPLACEMENT DRIVELINES**

# AFTERMARKET REPLACEMENT DRIVELINES

## MACHINE SPECIFIC SHAFTS

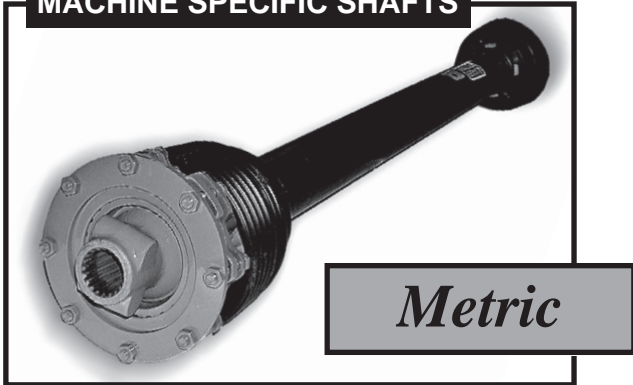

*Metric*

High Performance Friction Clutch specially developed for demanding field conditions for wing drives on flex wing and multiple disc mowers

STOCK NO.	USED ON DRIVE LINE
566-8620	14106656
566-8620	14106664
566-8621	14116664
566-8606	14126664

STOCK NO.	DESCRIPTION
98715000	Spring
970-1700	Disc



REPLACEMENT FRICTION CLUTCH



SCHULTE



WOODS



JOHN DEERE



BUSH HOG



RHINO / M & W



KODIAK



LAND PRIDE



BUSH-WHACKER

\*For Inner Profile Tube Replacement order: Stock No. 400-6745 - 45.0mm (5.4 Wall) mm

Interchanges with Bondioli & Pavesi

STOCK #	SERIES	DESCRIPTION	TORQUE RATING	COMP. OAL	APPLICATION
*14106656	ByPy 6	1-3/4" x 20 Clamp x 1-3/4" x 20 Clamp Fric.Cl.	15,000 in•lbs	56.11"	• M & W- A415, AGI 15 ft. Flex Wing • Rhino- FR15,SR15 15 ft. Rotary Cutter • Landpride- RC5515,RC6515 15 ft. Mower • Woods - BW180 Flex Wing
*14106664	ByPy 6	1-3/4" x 20 Clamp x 1-3/4" x 20 Clamp Fric.Cl.	15,000 in•lbs	64.11"	• Schulte - XH1500 Flex Wing • Bush Hog- 2515, 2720 Flex Wing • Deere- HX15 • Kodiak- Ol' Grizz 15 ft
*14116664	ByPy 6	1-3/8" x 21 Clamp x 1-3/8" x 21 Clamp Fric.Cl.	15,000 in•lbs	64.11"	• Schulte - FX26 • Deere- 1518, 2018
*14126664	ByPy 6	1-3/4" x 20 Clamp x 1-3/8" x 6 Clamp Fric.Cl.	15,000 in•lbs	64.11"	• Bush-Whacker - T-180

## ALL PURPOSE SHAFTS

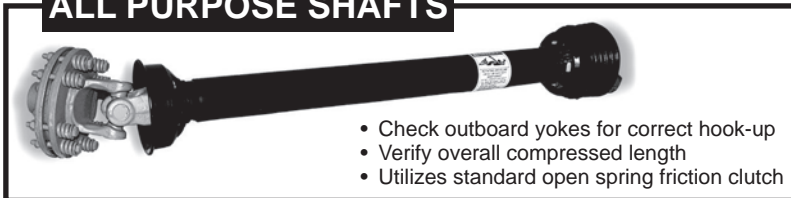

- Check outboard yokes for correct hook-up
- Verify overall compressed length
- Utilizes standard open spring friction clutch

## REPLACEMENT SPRING FRICTION CLUTCH

STOCK NO.	USED ON DRIVE LINE
566-8620	14106656
566-8620	14106664
566-8621	14116664

STOCK NO.	DESCRIPTION
970-4160	Disc

Interchanges with Bondioli & Pavesi

STOCK #	SERIES	DESCRIPTION	TORQUE RATING	COMP. OAL	APPLICATION
14106660	ByPy 6	1-3/8" x 6 Q.D. x 1-3/4" x 20 Clamp Fric.Cl.	13,200 in•lbs	61.15"	• Bush Hog - Various Models
14106661	ByPy 6	1-3/4" x 20 Q.D. x 1-3/4" x 20 Clamp Fric.Cl.	13,200 in•lbs	63.18"	• Bush Hog - Various Models
14116660	ByPy 6	1-3/8" x 6 Q.D. x 1-3/8" x 21 Clamp Fric.Cl.	13,200 in•lbs	61.15"	• Bush Hog - Various Models

NOTE: Replacement shafts may differ slightly from original equipment shafts

15,000 in•lbs = 1700 Nm & 13,200 in•lb = 1500 Nm

REPLACEMENT DRIVELINES



**Weasler®**

**MACHINE SPECIFIC SHAFTS**



*North American*

High Performance Friction Clutch specially developed for demanding field conditions for wing drives on flex wing and multiple disc mowers

**USED ON**

STOCK NO.	DRIVE LINE
566-4420	14104456
566-4420	14104464
566-4421	14114464
566-4406	14124464

**FRICITION CLUTCH REPLACEMENT PARTS:**

STOCK NO.	DESCRIPTION
98715000	Spring
970-1700	Disc



REPLACEMENT FRICTION CLUTCH



SCHULTE



WOODS

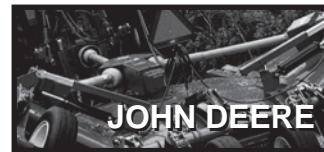

JOHN DEERE



BUSH HOG



RHINO / M & W



KODIAK



LAND PRIDE



BUSH-WACKER

NOTE: Replacement shafts may differ slightly from original equipment shafts

STOCK #	SERIES	DESCRIPTION	TORQUE RATING	COMP. OAL	APPLICATION
14104456	44	1-3/4" x 20 Clamp x 1-3/4" x 20 Clamp Fric.Cl.	15,000 in•lbs	56.11"	• M & W- A415, AGI 15 ft. Flex Wing • Rhino- FR15,SR15 15 ft. Rotary Cutter • Landpride- RC5515,RC6515 15 ft. Mower • Woods - BW180 Flex Wing
14104464	44	1-3/4" x 20 Clamp x 1-3/4" x 20 Clamp Fric.Cl.	15,000 in•lbs	64.11"	• Schulte- XH1500 Flex Wing • Bush Hog- 2515, 2720 Flex Wing • Deere- HX15 • Kodiak- OI' Grizz 15 ft
14114464	44	1-3/8" x 21 Clamp x 1-3/8" x 21 Clamp Fric.Cl.	15,000 in•lbs	64.11"	• Schulte- FX26 • Deere-1518, 2018
14124464	44	1-3/4" x 20 Clamp x 1-3/8" x 6 Clamp Fric.Cl.	15,000 in•lbs	64.11"	• Bush-Wacker- T-180

15,000 in•lbs = 1700 Nm

REPLACEMENT  
DRIVELINES

**ALSO AVAILABLE: NORTH AMERICAN AND METRIC 80° CV PRIMARY DRIVELINES FOR FLEXWING CUTTERS**



**80° CV DRIVELINES**

Contact your Weasler representative for additional information

## CONSTANT VELOCITY DRIVELINES...continued



### • ROUND BALERS •

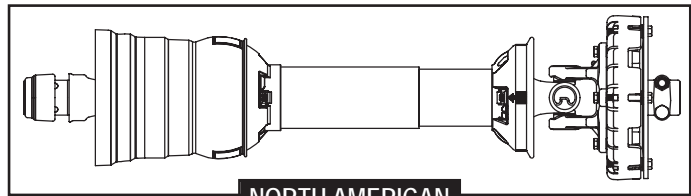

**NORTH AMERICAN**

Interchange with:

• **DEERE® Model No.: 466, 467, 566 & 567**

### COMPLETE DRIVELINE ASSEMBLY

STOCK #	MODEL#	TRACTOR YOKE	CLUTCH YOKE	FRICTION CLUTCH	CATEGORY	RPM
14505800	466 / 467	1 3/8" x 6 Spl.	1 3/8" x 6 Spl.	18,000 in•lb (9")	5/35R	540
14605800	566 / 567	1 3/8" x 21 Spl.	1 3/8" x 6 Spl.	10,000 in•lb (9")	5/35R	1000

(OVERALL COMPRESSED LENGTH - 60.3")

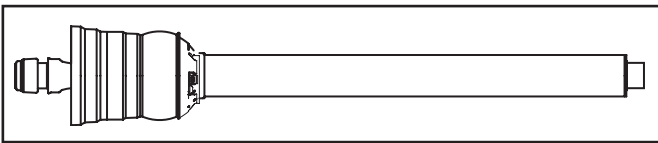

### DRIVELINE TRACTOR SHAFT HALF ASSEMBLY

STOCK #	TRACTOR YOKE	SHAFT HALF	CATEGORY
19505806	1 3/8" x 6 Spl.	1 11/16" x 20 Spl.	5/35R
19605821	1 3/8" x 21 Spl.	1 11/16" x 20 Spl.	5/35R

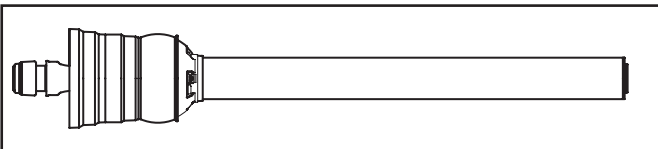

### DRIVELINE TRACTOR TUBE HALF ASSEMBLY

STOCK #	TRACTOR YOKE	TUBE HALF	CATEGORY
92-14505859	1 3/8" x 6 Spl.	2 1/2" O.D.	5/35R
92-14605859	1 3/8" x 21 Spl.	2 1/2" O.D.	5/35R

**NOTE:** The above two part numbers are provided with CV, tube and slip sleeve assembled. C.V. TUBE HALF to connect to TRACTOR PTO.

### • GEHL DELUXE MODEL No.: 2880

#### COMPLETE DRIVELINE ASSEMBLY

STOCK#	TRACTOR YOKE	CLUTCH YOKE	FRICTION CLUTCH	CATEGORY
14505801	1 3/8" x 6 Spl.	1 3/8" x 21 Spl.	15,000 in•lb (7")	5/35R

(OVERALL COMPRESSED LENGTH - 60")

#### DRIVELINE TRACTOR HALF ASSEMBLY

STOCK#	TRACTOR YOKE	CATEGORY
19505806	1 3/8" x 6 Spl.	5/35R



## CONSTANT VELOCITY DRIVELINES...continued



### • ROUND BALERS •

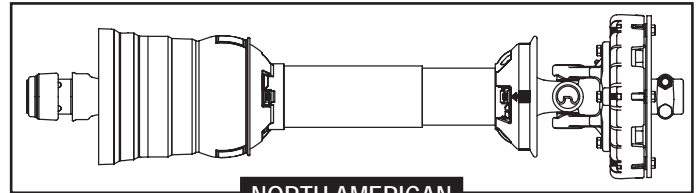

**NORTH AMERICAN**

Interchange with:

- VERMEER Model No.: 604K •
- CASE Model No.: 8455S & 8455T •
- HESSTON Model No.: 555S & 555T •

### COMPLETE DRIVELINE ASSEMBLY

STOCK #	TRACTOR YOKE	CLUTCH YOKE	FRICTION CLUTCH	CATEGORY	RPM
14505802	1 3/8" x 6 Spl.	1 3/8" x 6 Spl.	15,000 in•lb (7")	5/35R	540
14605802	1 3/8" x 21 Spl.	1 3/8" x 6 Spl.	15,000 in•lb (7")	5/35R	1000

(OVERALL COMPRESSED LENGTH - 58")

### DRIVELINE TRACTOR HALF ASSEMBLY

STOCK#	TRACTOR YOKE	CATEGORY
19505806	1 3/8" x 6 Spl.	5/35R
19605821	1 3/8" x 21 Spl.	5/35R

REPLACEMENT DRIVELINES



### • BEET HARVESTERS •

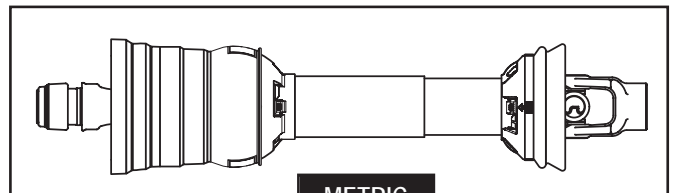

**METRIC**

• LENGTH MAY NEED TO BE MODIFIED TO FIT SPECIFIC MODELS

### COMPLETE DRIVELINE ASSEMBLY

STOCK #	TRACTOR YOKE	MACHINE YOKE	OAL COMPRESSED	CATEGORY
14606862	1 3/8" x 21 Spl. SSL	1 3/4" Rd. w/Keyway	62.4"	6
14706862	1 3/4" x 20 Spl. SSL	1 3/4" Rd. w/Keyway	62.4"	6

(OVERALL COMPRESSED LENGTH - 62.4")

## CONSTANT VELOCITY DRIVELINES...continued

### • PEANUT HARVESTERS •

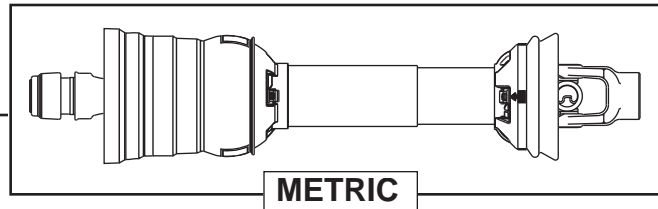

METRIC



KMC MODEL No.:  
33, 3350, 3355, 3360



AMADAS MODEL No.:  
9097, 9297, 9597, 9797, 9897, 9897T,  
9997A, 9997B, 9997E, 9997T,  
M2100D/M9997T, M2100A/M9997A

### COMPLETE DRIVELINE ASSEMBLY

STOCK #	TRACTOR YOKE	IMPLEMENT YOKE	CATEGORY
14626855	1 3/8" x 21 Spl.	1 3/8" x 21 Spl. Clamp	6
14636855	1 3/8" x 21 Spl.	1 3/8" x 21 Spl. w/Pinhole	6
14726855	1 3/4" x 20 Spl.	1 3/8" x 21 Spl. Clamp	6
14736855	1 3/4" x 20 Spl.	1 3/8" x 21 Spl. w/Pinhole	6

(OVERALL COMPRESSED LENGTH - 55")

### DRIVELINE TRACTOR HALF ASSEMBLY

STOCK#	TRACTOR YOKE	CATEGORY
93-14616855	1 3/8" x 21 Spl.	6
93-14716855	1 3/4" x 20 Spl.	6

### DRIVELINE MACHINE HALF ASSEMBLY

STOCK#	TRACTOR YOKE	CATEGORY
92-14626855	1 3/8" x 21 Clamp	6
92-14636855	1 3/8" x 21 Spl. w/Pinhole	6

### COMPLETE DRIVELINE ASSEMBLY (NON-CV)

STOCK #	TRACTOR YOKE	MACHINE YOKE	OAL COMPRESSED	SERIES
14007955	1 3/4" x 20 Spl. QD	1 3/8" x 21 Spl. w/Pinhole	55"	W/S 2500

(Star Tubing)





## METRIC DRIVELINES

Interchange with Bondioli & Pavesi and Walterscheid

### • COMBINE HEADERS •

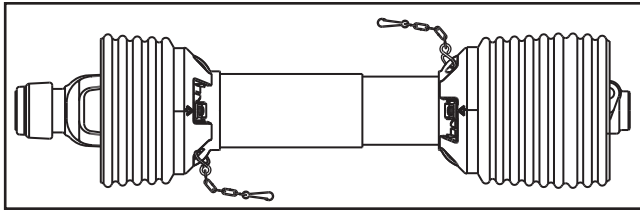

- LENGTH MAY NEED TO BE MODIFIED TO FIT SPECIFIC HEADERS
- CHAINS INCLUDED

STOCK #	COMBINE YOKE	HEADER YOKE	OAL COMPRESSED	DESCRIPTION	SERIES
14007631	1 3/8" x 21 Spl.	1 1/8" Hex Clamp	31"	Deere Headers using (1) Driveline per Header	W/S 2400
14007633	1 1/8" Hex SSL	1 1/8" Hex Clamp	33"	Case IH Combine using Deere Header	W/S 2400
14007635	1 3/8" x 21 Spl.	1 1/8" Hex Clamp	35"	Deere Headers using (2) Drivelines per Header	W/S 2400

### NORTH AMERICAN DRIVELINE OPTION

14013531	1 3/8" x 21 Spl.	1 1/8" Hex Clamp	31"	90, 900 & 600 Series Platforms	35R
----------	------------------	------------------	-----	--------------------------------	-----



### • SNOWBLOWERS •

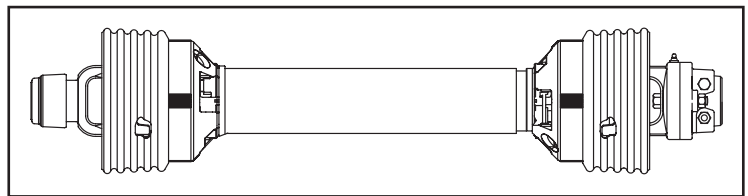

STOCK #	TRACTOR YOKE	IMPLEMENT CLAMP SHEAR BOLT YOKE	OAL COMPRESSED	SHEAR VALUE	SERIES
14406231	1 3/8" x 6 Spl. SSL	1" Rd. w/Keyway	31"	8,000 in-lbs	ByPy 2
14406428	1 3/8" x 6 Spl. SSL	1 1/4" Rd. w/Keyway	28"	16,400 in-lbs	ByPy 4
14406632	1 3/8" x 6 Spl. SSL	1 1/2" Rd. w/Keyway	32"	18,600 in-lbs	ByPy 6
14406639	1 3/8" x 6 Spl. SSL	1 3/8" x 6 Spl.	39"	16,400 in-lbs	ByPy 6
14406832	1 3/8" x 6 Spl. SSL	1 1/2" Rd. w/Keyway	32"	22,000 in-lbs	ByPy 8

# AFTERMARKET REPLACEMENT DRIVELINES

## METRIC DRIVELINES...continued

Interchange with Bondioli & Pavesi and Walterscheid

### • ALL PURPOSE •

STOCK #	TRACTOR YOKE	IMPLEMENT YOKE	OAL COMPRESSED	SERIES
14006137	1 3/8" x 6 Spl. QD	1 3/8" x 6 Spl. QD	37"	BYPY 1
14006247	1 3/8" x 6 Spl. QD	1 3/8" x 6 Spl. QD	47"	BYPY 2
14006438	1 3/8" x 6 Spl. QD	1 3/8" x 6 Spl. QD	38"	BYPY 4
14006448	1 3/8" x 6 Spl. QD	1 3/8" x 6 Spl. QD	48"	BYPY 4
14006455	1 3/8" x 6 Spl. QD	1 3/8" x 6 Spl. QD	55"	BYPY 4
14006543	1 3/8" x 6 Spl. QD	1 3/8" x 6 Spl. QD	43"	BYPY 5
14006555	1 3/8" x 6 Spl. QD	1 3/8" x 6 Spl. QD	55"	BYPY 5
14006642	1 3/8" x 6 Spl. QD	1 3/8" x 6 Spl. QD	42"	BYPY 6
14006644	1 3/8" x 6 Spl. QD	1 3/8" x 6 Spl. QD	44"	BYPY 6
14006655	1 3/8" x 6 Spl. QD	1 3/8" x 6 Spl. QD	55"	BYPY 6
14006657	1 3/8" x 6 Spl. QD	1 3/8" x 6 Spl. QD	57"	BYPY 6
14006846	1 3/8" x 6 Spl. QD	1 3/8" x 6 Spl. QD	46"	BYPY 8
14006857	1 3/8" x 6 Spl. QD	1 3/8" x 6 Spl. QD	57"	BYPY 8
14016542	1 3/8" x 6 Spl. QD	1 3/8" x 6 Spl. QD	42"	BYPY 5
14016666	1 3/8" x 21 Spl. QD	1 3/8" Rd. w/Pinhole	66"	BYPY 6
14066644	1 3/8" x 21 Spl. QD	1 3/8" x 21 Spl. QD	44"	BYPY 6
14066846	1 3/8" x 21 Spl. QD	1 3/8" x 21 Spl. QD	46"	BYPY 8

### • CATFISH POND DRIVELINE •

STOCK #	TRACTOR YOKE	IMPLEMENT YOKE	OAL COMPRESSED	SERIES
14006424	1 3/8" x 6 Spl. QD	1 1/2" Rd.	48"	BYPY 4
14006524	1 3/8" x 6 Spl. QD	1 1/2" Rd.	48"	BYPY 5
14006624	1 3/8" x 6 Spl. QD	1 1/2" Rd.	48"	BYPY 6
14016524	1 3/8" x 21 Spl. QD	1 1/2" Rd.	48"	BYPY 5
14016624	1 3/8" x 21 Spl. QD	1 1/2" Rd.	48"	BYPY 6

### • DISC MOWER •

STOCK #	TRACTOR YOKE	IMPLEMENT YOKE	OAL COMPRESSED	SERIES
14306538	1 3/8" x 6 Spl. QD	1 3/8" x 6 Spl. w/Overrunning Clutch	38"	BYPY 5
14306639	1 3/8" x 6 Spl. QD	1 3/8" x 6 Spl. w/Overrunning Clutch	39"	BYPY 6
14307645	1 3/8" x 6 Spl. QD	1 3/8" x 6 Spl. w/Overrunning Clutch	45"	W/S 2400



## METRIC DRIVELINES...continued

Interchange with Bondioli & Pavesi and Walterscheid

### • FERTILIZER SPREADER •

STOCK #	TRACTOR YOKE	IMPLEMENT YOKE	OAL COMPRESSED	SERIES
14006127	1 3/8" x 6 Spl. QD	1 3/8" x 6 Spl. QD	27"	BYPY 1
14006135	1 3/8" x 6 Spl. QD	1 3/8" x 6 Spl. QD	35"	BYPY 1

### • FINISHING MOWER •

STOCK #	TRACTOR YOKE	IMPLEMENT YOKE	OAL COMPRESSED	SERIES
14006340	1 3/8" x 6 Spl. QD	1 3/8" x 6 Spl. QD	40"	BYPY 3
14006446	1 3/8" x 6 Spl. QD	1 3/8" x 6 Spl. QD	46"	BYPY 4
14006637	1 3/8" x 6 Spl. QD	1 3/8" x 6 Spl. QD	37"	BYPY 6

### • HAMMER MILL •

STOCK #	TRACTOR YOKE	IMPLEMENT YOKE	OAL COMPRESSED	SERIES
14006628	1 3/8" x 6 Spl. QD	1 3/4" Rd.	57"	BYPY 6
14006748	1 3/8" x 6 Spl. QD	1 3/4" Rd.	48"	BYPY 7

### • HAY TEDDER •

STOCK #	TRACTOR YOKE	IMPLEMENT YOKE	OAL COMPRESSED	TYPE	SERIES
14206252*	1 3/8" x 6 Spl. QD	1 3/8" x 6 Spl. w/Ratchet Clutch	52"	2-Rotor	BYPY 2
14206454**	1 3/8" x 6 Spl. QD	1 3/8" x 6 Spl. w/Ratchet Clutch	54"	4-Rotor	BYPY 4

\*Light Duty \*\*Heavy Duty

### • PEANUT HARVESTER (NON-CV) •

STOCK #	TRACTOR YOKE	IMPLEMENT YOKE	OAL COMPRESSED	SERIES
14007955	1 3/4" x 20 Spl. QD	1 3/8" x 21 Spl. w/Pinhole	55"	W/S 2500

(Star Tubing)

# AFTERMARKET REPLACEMENT DRIVELINES

## METRIC DRIVELINES . . . continued

Interchange with Bondioli & Pavesi and Walterscheid

### • POST HOLE DIGGER •

STOCK #	TRACTOR YOKE	IMPLEMENT YOKE	OAL COMPRESSED	SERIES
14006252	1 3/8" x 6 Spl. QD	1 1/4" Rd. w/Pinhole	52"	BYPY 2 (Light Duty)
14006453	1 3/8" x 6 Spl. QD	1 1/4" Rd. w/Pinhole	53"	BYPY 4 (Heavy Duty)

### • ROTARY CUTTER •

STOCK #	TRACTOR YOKE	IMPLEMENT YOKE	OAL COMPRESSED	APPLICATION	SERIES
14006251	1 3/8" x 6 Spl. QD	1 3/8" Rd. w/Pinhole	51"	Pull (Towed)	BYPY 2
14006432	1 3/8" x 6 Spl. QD	1 3/8" Rd. w/Pinhole	32"	4 ft. Lift (3-Pt.Hitch)	BYPY 4
14006436	1 3/8" x 6 Spl. QD	1 3/8" Rd. w/Pinhole	36"	5 ft. Lift (3-Pt.Hitch)	BYPY 4
14006442	1 3/8" x 6 Spl. QD	1 3/8" Rd. w/Pinhole	42"	6 ft. Lift (3-Pt.Hitch)	BYPY 4
14006451	1 3/8" x 6 Spl. QD	1 3/8" Rd. w/Pinhole	51"	Pull (Towed)	BYPY 4
14006542	1 3/8" x 6 Spl. QD	1 3/8" Rd. w/Pinhole	42"	6 ft. Lift (3-Pt.Hitch)	BYPY 5
14006546	1 3/8" x 6 Spl. QD	1 3/8" x 6 Spl. QD	46"	6 ft. Lift (3-Pt.Hitch)	BYPY 5
14006551	1 3/8" x 6 Spl. QD	1 3/8" Rd. w/Pinhole	51"	6 ft. Lift (3-Pt.Hitch)	BYPY 5
14006652	1 3/8" x 6 Spl. QD	1 3/8" Rd. w/Pinhole	52"	7 ft. Lift (3-Pt.Hitch)	BYPY 6

### • ROTARY CUTTER/TILLER •

STOCK #	TRACTOR YOKE	IMPLEMENT CLAMP YOKE	OAL COMPRESSED	APPLICATION	SERIES
14106233	1 3/8" x 6 Spl. QD	1 3/8" x 6 Spl. w/Fric. Clutch	33"	Pull (Towed)	BYPY 2
14106436	1 3/8" x 6 Spl. QD	1 3/8" x 6 Spl. w/Fric. Clutch	36"	Pull (Towed)	BYPY 4
14106438	1 3/8" x 6 Spl. QD	1 3/8" x 6 Spl. w/Fric. Clutch	38"	Pull (Towed)	BYPY 4
14106546	1 3/8" x 6 Spl. QD	1 3/8" x 6 Spl. w/Fric. Clutch	46"	Pull (Towed)	BYPY 5
14106654	1 3/8" x 6 Spl. QD	1 3/8" x 6 Spl. w/Fric. Clutch	54"	7 ft. Lift (3-Pt.Hitch)	BYPY 6
14106660	1 3/8" x 6 Spl. QD	1 3/4" x 20 Spl. w/Fric. Clutch	60"	7 ft. Lift (3-Pt.Hitch)	BYPY 6
14106661	1 3/4" x 20 Spl. QD	1 3/4" x 20 Spl. w/Fric. Clutch	61"	7 ft. Lift (3-Pt.Hitch)	BYPY 6



## NORTH AMERICAN DRIVELINES

### • ALL PURPOSE •

STOCK #	TRACTOR YOKE	IMPLEMENT YOKE	OAL COMPRESSED	SERIES
14000605	1 3/8" x 6 Spl. Spring Lok	1" Rd. w/Pinhole	32"	6R
14000638	1 3/8" x 6 Spl. QD	1" Rd. w/Pinhole	38"	6R
14003536	1 3/8" x 6 Spl. SSL	1 3/8" x 6 Spl. SSL	36"	35R
14005537	1 3/8" x 6 Spl. SSL	1 3/8" x 6 Spl. SSL	37"	55R
14005546	1 3/4" x 20 Spl. SSL	1 3/4" Rd. w/Keyway & 2 Set Screws	46"	55R

### • AUGER •

STOCK #	TRACTOR YOKE	IMPLEMENT YOKE	OAL COMPRESSED	SERIES
14000616	1 3/8" x 6 Spl. Spring Lok	1" Rd. w/Keyway	48"	6R
14001220	1 3/8" x 6 Spl. Spring Lok	1 1/4" Rd. w/Keyway	48"	12R
14001420	1 3/8" x 6 Spl. Spring Lok	1 1/4" Rd. w/Keyway	48"	14R

### • CATFISH POND DRIVELINE •

STOCK #	TRACTOR YOKE	IMPLEMENT YOKE	OAL COMPRESSED	SERIES
14003524	1 3/8" x 6 Spl. QD	1 1/2" Rd. w/Keyway	48"	35R
14004424	1 3/8" x 6 Spl. QD	1 1/2" Rd. w/Keyway	48"	44R

### • FERTILIZER SPREADER •

STOCK #	TRACTOR YOKE	IMPLEMENT YOKE	OAL COMPRESSED	SERIES
14000620	1 3/8" x 6 Spl. Spring Lok	1 3/8" x 6 Spl. Spring Lok	27"	6R

### • FINISHING MOWER •

STOCK #	TRACTOR YOKE	IMPLEMENT YOKE	OAL COMPRESSED	SERIES
14000600	1 3/8" x 6 Spl. Spring Lok	1" Rd. w/Pinhole	39"	6R

### • POSTHOLE DIGGER •

STOCK #	TRACTOR YOKE	IMPLEMENT YOKE	OAL COMPRESSED	SERIES
14001200	1 3/8" x 6 Spl. QD	1 1/4" Rd. w/Keyway	48"	12R

### • ROTARY CUTTER •

STOCK #	TRACTOR YOKE	IMPLEMENT YOKE	APPLICATION	OAL COMPRESSED	SERIES
14001404	1 3/8" x 6 SSL	1 3/8" Rd. w/Pinhole	4 Ft. Lift-type	30"	14R
14001405	1 3/8" x 6 SSL	1 3/8" Rd. w/Pinhole	5 Ft. Lift-type	37"	14R
14001406	1 3/8" x 6 SSL	1 3/8" Rd. w/Pinhole	5 Ft. & 6 Ft. Pull-type	56"	14R
14003507	1 3/8" x 6 SSL	1 3/8" Rd. w/Pinhole	7 Ft. Pull-type	65"	35R

# AFTERMARKET REPLACEMENT DRIVELINES

## CONSTANT VELOCITY - NORTH AMERICAN

ORDER IMPLEMENT YOKE AND CROSS AND BEARING KIT SEPARATELY AS REQUIRED

### • 80° CV CATEGORY 3 •

STOCK #	TRACTOR YOKE	OAL COMPRESSED	MAX.EXTENDED OPERATING LENGTH	SHAFT SIZE
14553848	1 3/8" x 6 Spl. SSL	48"	67"	1" x 1-1/8"
14653848	1 3/8" x 21 Spl. SSL	48"	67"	1" x 1-1/8"

#### DRIVELINE TRACTOR HALF ASSEMBLY

STOCK#	TRACTOR YOKE	CATEGORY
19553800	1 3/8" x 6 Spl.	3
19653800	1 3/8" x 21 Spl.	3

#### DRIVELINE MACHINE HALF ASSEMBLY

STOCK#	OVERALL DRIVELINE LENGTH	CATEGORY
17501448	48"	3

### • 80° CV CATEGORY 4 •

STOCK #	TRACTOR YOKE	OAL COMPRESSED	MAX.EXTENDED OPERATING LENGTH	SHAFT SIZE
14558648	1 3/8" x 6 Spl. SSL	48"	67"	1 5/16" x 20 Spl.
14558658	1 3/8" x 6 Spl. SSL	58"	77"	1 5/16" x 20 Spl.
14658648	1 3/8" x 21 Spl. SSL	48"	67"	1 5/16" x 20 Spl.
14658658	1 3/8" x 21 Spl. SSL	58"	77"	1 5/16" x 20 Spl.
14758648	1 3/4" x 20 Spl. SSL	48"	67"	1 5/16" x 20 Spl.
14758658	1 3/4" x 20 Spl. SSL	58"	77"	1 5/16" x 20 Spl.

REPLACEMENT  
DRIVELINES

#### DRIVELINE TRACTOR HALF ASSEMBLY

STOCK#	TRACTOR YOKE	CATEGORY
19558600	1 3/8" x 6 Spl.	4
19658600	1 3/8" x 21 Spl.	4
19758600	1 3/4" x 20 Spl.	4

#### DRIVELINE MACHINE HALF ASSEMBLY

STOCK#	OVERALL DRIVELINE LENGTH	CATEGORY
17513548	48"	4
17513558	58"	4



## CONSTANT VELOCITY - NORTH AMERICAN ...continued

ORDER IMPLEMENT YOKE AND CROSS AND BEARING KIT SEPARATELY AS REQUIRED

### • 80° CV CATEGORY 5 / 35/44 SERIES •

STOCK #	TRACTOR YOKE	OAL COMPRESSED	MAX. EXTENDED OPERATING LENGTH	SHAFT SIZE	CATEGORY
14505848	1 3/8" x 6 Spl. SSL	48"	67"	1 11/16" x 20 Spl.	5/35
14505858	1 3/8" x 6 Spl. SSL	58"	77"	1 11/16" x 20 Spl.	5/35
14505867	1 3/8" x 6 Spl. SSL	67"	84"	1 11/16" x 20 Spl.	5/35
14545848	1 3/8" x 6 Spl. SSL	48"	67"	1 11/16" x 20 Spl.	5/44
14545858	1 3/8" x 6 Spl. SSL	58"	77"	1 11/16" x 20 Spl.	5/44
14545867	1 3/8" x 6 Spl. SSL	67"	84"	1 11/16" x 20 Spl.	5/44
14605848	1 3/8" x 21 Spl. SSL	48"	67"	1 11/16" x 20 Spl.	5/35
14605858	1 3/8" x 21 Spl. SSL	58"	77"	1 11/16" x 20 Spl.	5/35
14605867	1 3/8" x 21 Spl. SSL	67"	84"	1 11/16" x 20 Spl.	5/35
14645848	1 3/8" x 21 Spl. SSL	48"	67"	1 11/16" x 20 Spl.	5/44
14645858	1 3/8" x 21 Spl. SSL	58"	77"	1 11/16" x 20 Spl.	5/44
14645867	1 3/8" x 21 Spl. SSL	67"	84"	1 11/16" x 20 Spl.	5/44
14705848	1 3/4" x 20 Spl. SSL	48"	67"	1 11/16" x 20 Spl.	5/35
14705858	1 3/4" x 20 Spl. SSL	58"	77"	1 11/16" x 20 Spl.	5/35
14705867	1 3/4" x 20 Spl. SSL	67"	84"	1 11/16" x 20 Spl.	5/35
14745848	1 3/4" x 20 Spl. SSL	48"	67"	1 11/16" x 20 Spl.	5/44
14745858	1 3/4" x 20 Spl. SSL	58"	77"	1 11/16" x 20 Spl.	5/44
14745867	1 3/4" x 20 Spl. SSL	67"	84"	1 11/16" x 20 Spl.	5/44

REPLACEMENT  
DRIVELINES

### DRIVELINE TRACTOR HALF ASSEMBLY

STOCK#	TRACTOR YOKE	CATEGORY
19505806	1 3/8" x 6 Spl.	5/35R
19605821	1 3/8" x 21 Spl.	5/35R
19705820	1 3/4" x 20 Spl.	5/35R

### DRIVELINE MACHINE HALF ASSEMBLY

STOCK#	OVERALL D'LINE LENGTH	CATEGORY
17503548	48"	5/35R
17503558	58"	5/35R
17503567	67"	5/35R
17503573	73"	5/35R
17503579	79"	5/35R
17504448	48"	5/44R
17504458	58"	5/44R
17504467	67"	5/44R
17504473	73"	5/44R
17504479	79"	5/44R

# AFTERMARKET REPLACEMENT DRIVELINES

## CONSTANT VELOCITY - NORTH AMERICAN *...continued*

ORDER IMPLEMENT YOKE AND CROSS AND BEARING KIT SEPARATELY AS REQUIRED

### • 80° CV CATEGORY 6 •

STOCK #	TRACTOR YOKE	OAL COMPRESSED	MAX.EXTENDED OPERATING LENGTH	SHAFT SIZE
14556848	1 3/8" x 6 Spl. SSL	48"	67"	1 11/16" x 20 Spl.
14556858	1 3/8" x 6 Spl. SSL	58"	80"	1 11/16" x 20 Spl.
14556867	1 3/8" x 6 Spl. SSL	67"	84"	1 11/16" x 20 Spl.
14656848	1 3/8" x 21 Spl. SSL	48"	67"	1 11/16" x 20 Spl.
14656858	1 3/8" x 21 Spl. SSL	58"	80"	1 11/16" x 20 Spl.
14656867	1 3/8" x 21 Spl. SSL	67"	84"	1 11/16" x 20 Spl.
14756848	1 3/4" x 20 Spl. SSL	48"	67"	1 11/16" x 20 Spl.
14756858	1 3/4" x 20 Spl. SSL	58"	80"	1 11/16" x 20 Spl.
14756867	1 3/4" x 20 Spl. SSL	67"	84"	1 11/16" x 20 Spl.

### DRIVELINE TRACTOR HALF ASSEMBLY

STOCK#	TRACTOR YOKE	CATEGORY
19556800	1 3/8" x 6 Spl.	6
19656800	1 3/8" x 21 Spl.	6
19756800	1 3/4" x 20 Spl.	6

### DRIVELINE MACHINE HALF ASSEMBLY

STOCK#	OVERALL DRIVELINE LENGTH	CATEGORY
17505548	48"	6
17505558	58"	6
17505567	67"	6
17505573	73"	6
17505579	79"	6

REPLACEMENT  
DRIVELINES







## Aftermarket Product Guide



# North American

## Drivelines and Components

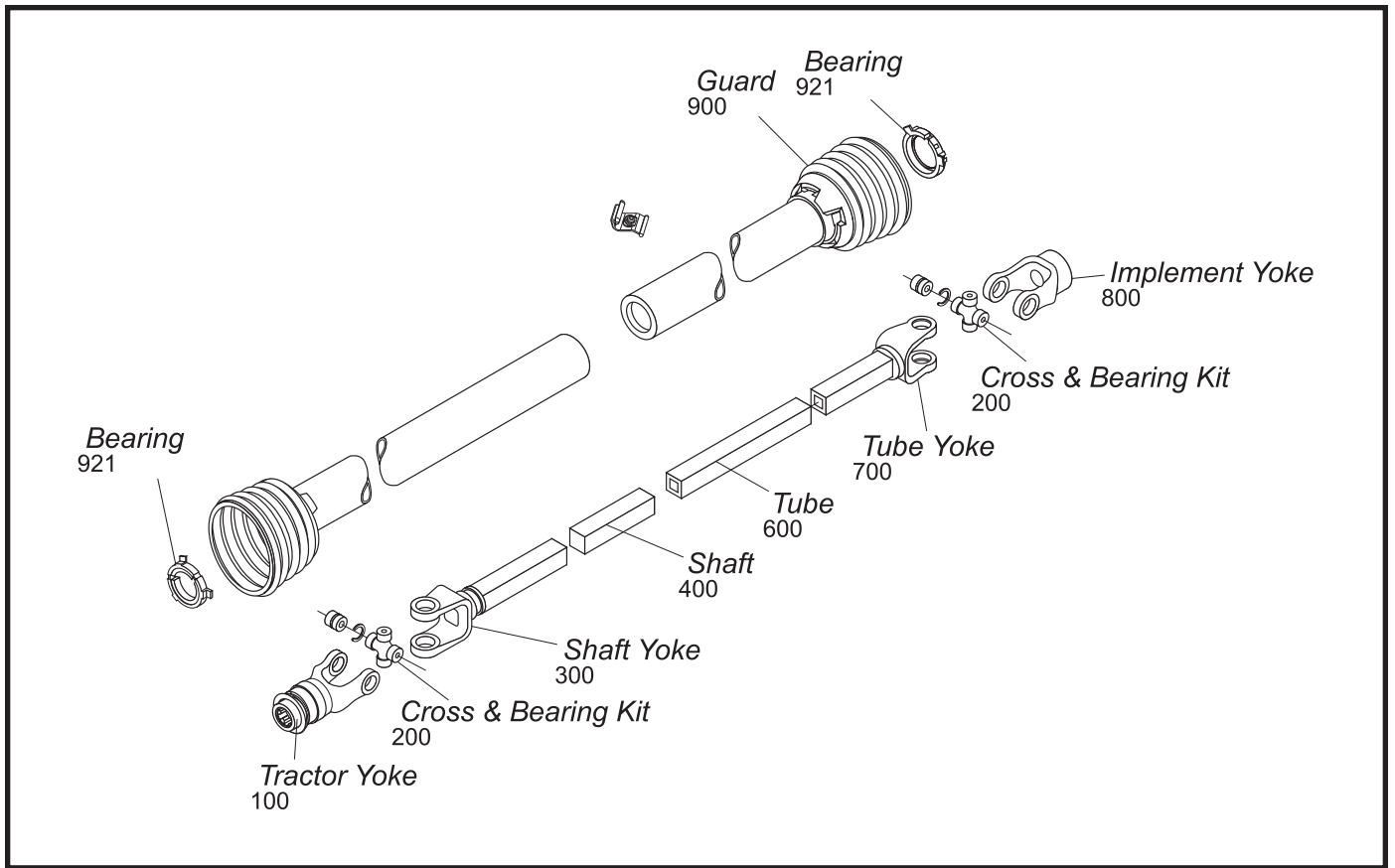

Each series has an exploded view for identification purposes. The drawing illustrates the components in the same sequence as an implement input driveline transmitting power from tractor to implement. Each component of the exploded view is identified by an eight digit stock number to insure correct identification of each component.

Example: 100 prefix denotes a Spring-Lok Tractor Yoke on the exploded view.

[When ordering a tractor yoke, be sure the stock number begins with 100.]

Number Identification Examples:

102 - 06 06  
 |  
 | 6 Spline  
 | 6 Series  
 | QD Yoke  
 | Tractor Yoke

602 - 44 00  
 |  
 | 44 Series  
 | Tube

200 - 06 00  
 |  
 | 6 Series  
 | Cross & Bearing Kit

701 - 44 00  
 |  
 | 44 Series  
 | Tube Weld Yoke

300 - 12 00  
 |  
 | 12 Series  
 | Shaft Weld Yoke

800 - 35 24  
 |  
 | \*1 1/2" Round Bore  
 | 35 Series  
 | Implement Yoke

400 - 16 - 18  
 |  
 | \*1 1/8"  
 | \*1"  
 | Shaft

900 - 45 48  
 |  
 | For 48" O.A. Driveline  
 | Guard Type  
 | Plastic Guard

500 - 35 00  
 |  
 | 35 Series  
 | Slip Sleeve

(\* Expressed in 1/16th inches)

# TRANSPARENCY IDENTIFICATION SYSTEM

for Driveline Components  
(Stock No. 12002500)

The individual transparency cards will allow the user to easily identify driveline components. Cross and Bearing Kits may be identified by the bearing cap outside diameter and the width of the cross. Yokes may be identified by the hole in the ear and profile. Tubes and shafts may be identified by the end sections.

How to use the Transparency Identification System:

1. Match the part to be replaced with the corresponding transparency card for identification.
2. Select the proper stock number for the replacement part.

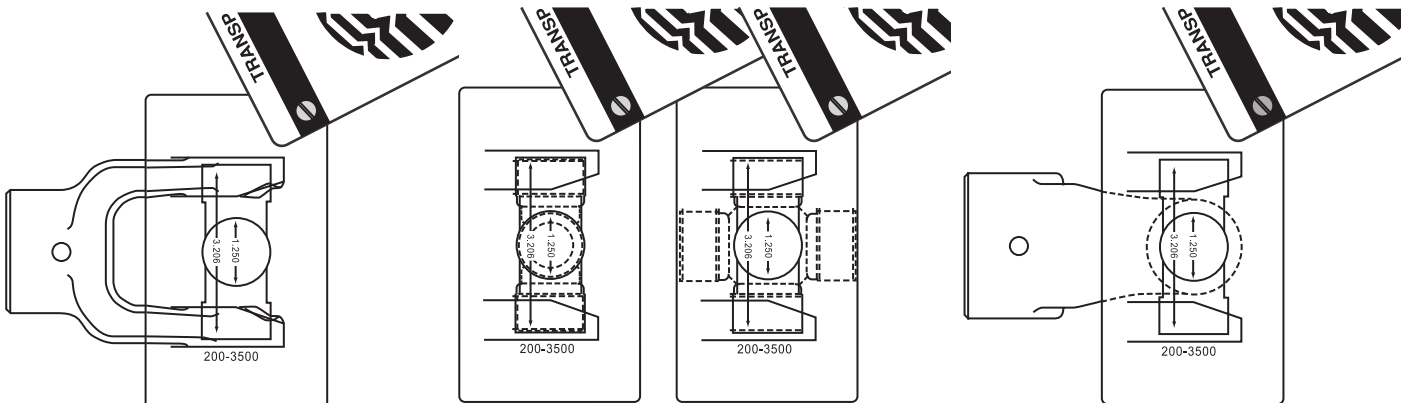
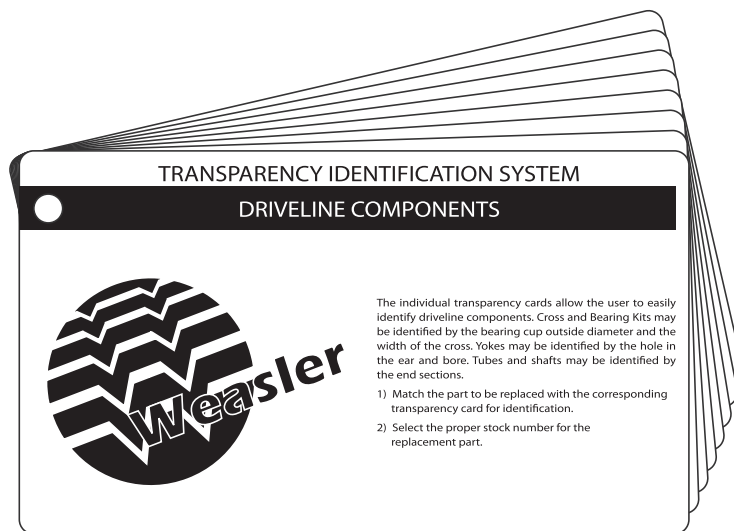

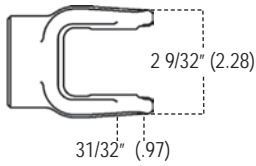

# 6 Series

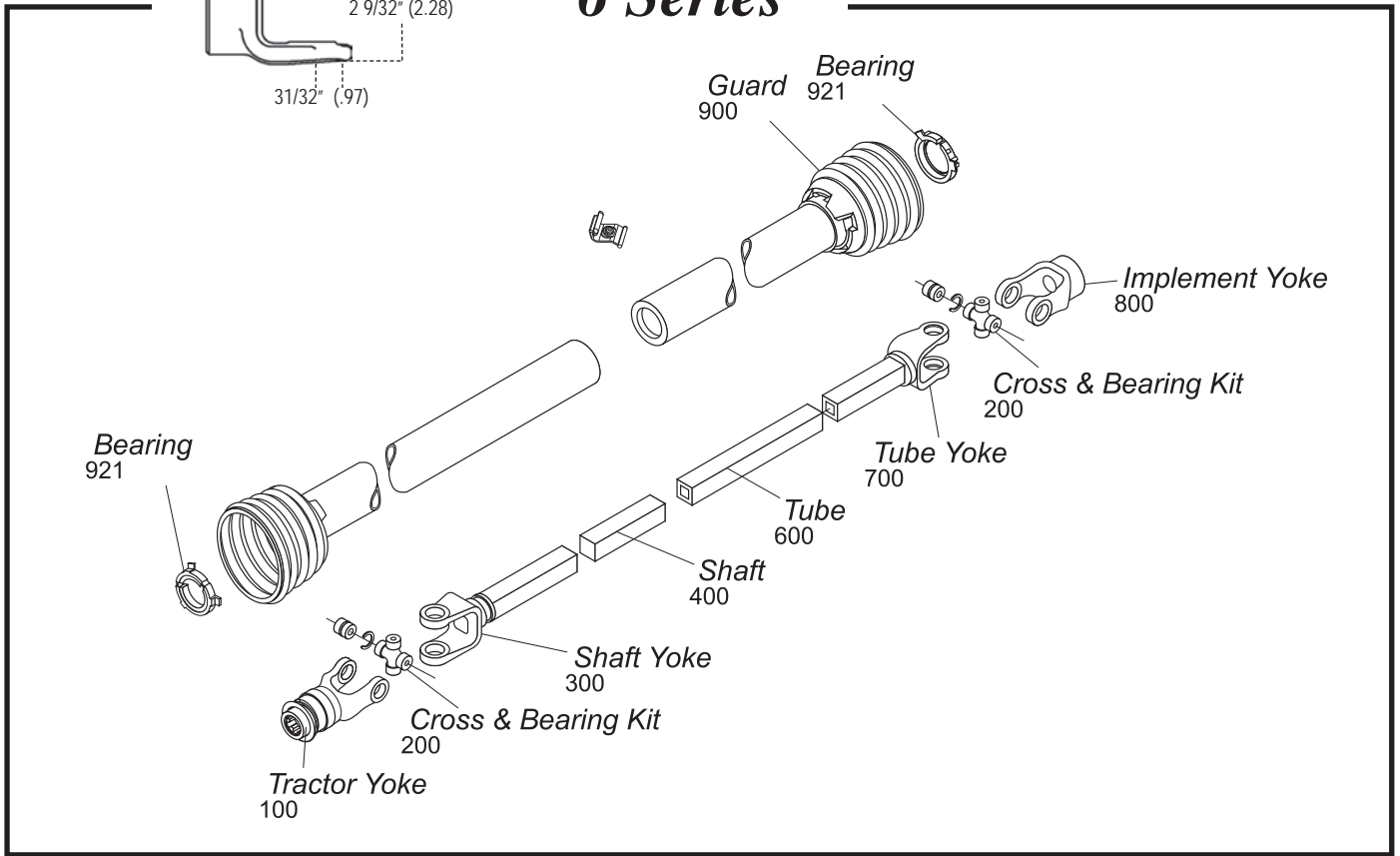

## Tractor Yoke

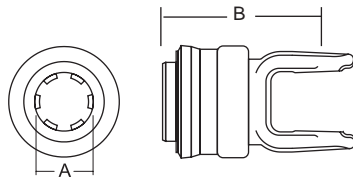

### Spring-Lok

Repair Kit — 13003100

Stock Number	Dim. "A" Bore	Dim. "B"
100-0606	1 3/8" x 6 Spl.	3 7/8"
100-0621	1 3/8" x 21 Spl.	3 7/8"

### Spring-Lok (metal collar) Lawn & Garden

Repair Kit — 13003115

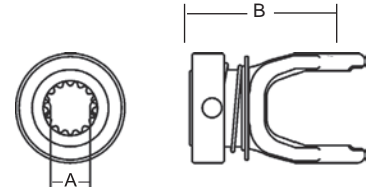

Stock Number	Dim. "A" Bore	Dim. "B"
105-0610	.98" x 10 Spl.	2 3/4"
105-0615	1" x 15 Spl.	2 3/4"

### Auto-Lok

Repair Kit — 13004015

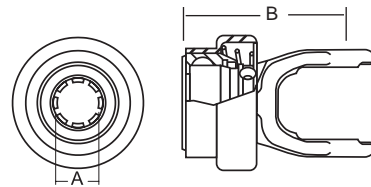

Stock Number	Dim. "A" Bore	Dim. "B"
101-0610	.98" x 10 Spl.	3 1/8"
101-0615	1" x 15 Spl.	3 1/8"

### Male Spline Lawn & Garden

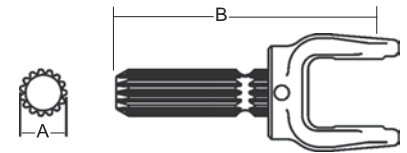

Stock Number	Dim. "A"	Dim. "B"
106-0615	1" x 15 Spl.	5 3/8"

### Quick Disconnect

Repair Kit —  
\*13002006  
\*\*13002021

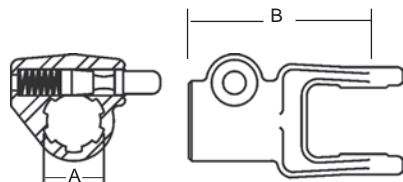

Stock Number	Dim. "A" Bore	Dim. "B"
102-0606*	1 3/8" x 6 Spl.	3 7/8"
102-0621**	1 3/8" x 21 Spl.	3 7/8"

### Cross & Bearing Kit (R Kit)

(Recommended 8 hour grease interval)

Snap Ring Located in Bushing

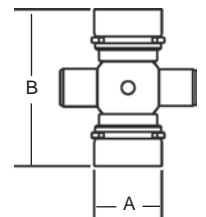

Stock Number	Dim. "A"	Dim. "B"
200-0600	31/32"	2 9/32"

**Extended Lubrication Cross & Bearing Kit (E-Kit)**

(Recommended 50 hour grease interval)  
Snap Ring Located in Bushing

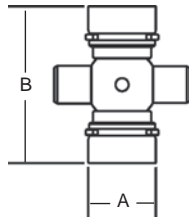

Stock Number	Dim. "A" Bore	Dim. "B"
201-0600	31/32"	2 9/32"

**Shaft Weld Yoke**

With Bearing Groove  
(Guard must rotate freely on yoke)

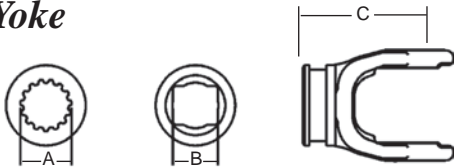

Stock Number	Dim. "A" Bore	Dim. "B" Bore	Dim. "C"
300-0600		3/4" x 7/8"	2 1/2"
302-0600*	1" x 15 Spl.		2 1/4"
303-0600*		3/4" x 7/8"	2 1/4"

\*Requires nylon bearing part 04-15169

Without Bearing Groove

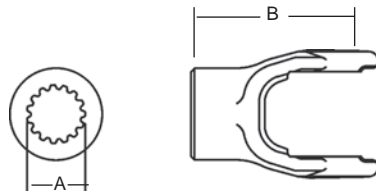

Stock Number	Dim. "A" Bore	Dim. "B"
301-0600	1" x 15 Spl.	2 1/2"

**Shaft**

3/4" x 7/8" Rectangular



Stock Number	Length
400-1214	6'
404-1214	3'

1" x 15 Spline  
(Induction Hardened)



Stock Number	Major Diameter	Length
404-1615H	1.00" / .995"	3'

**Slip Sleeve**

With Grease Groove

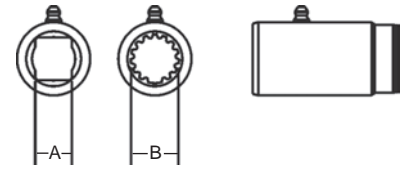

Stock Number	Length	Dim. "A" Bore	Dim. "B" Bore	Fits Tube Size
510-0600	4"	3/4" x 7/8" Rect.		1 1/2" (.065 Wall)
510-0615	3"		1" x 15 Spl.	1 1/2" (.065 Wall)

**Tube**

1" x 1 1/8" Rectangular O.D.



Stock Number	Length	Fits Shaft
600-1618	6'	3/4" x 7/8"
604-1618	3'	3/4" x 7/8"

1 1/2" Round (.065 Wall) O.D.



Stock Number	Length
602-0600	6'
604-0600	3'

**Tube Weld Yoke**

With Bearing Groove  
(Guard must rotate freely on yoke)

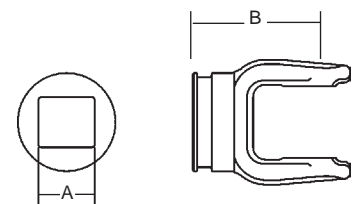

Stock Number	Dim. "A" Bore	Dim. "B"
700-0600	1" x 1 1/8"	2 1/2"

(Guard must rotate freely on yoke)

Stock Number	Dim. "A"	Fits Tube Size
701-0600	3 5/8"	1 1/2" (.065 Wall)
702-0600 (without Bearing Groove)	2 1/2"	1 1/2" (.065 Wall)
703-0600 (with Groove)	2 1/2"	1 1/2" (.065 Wall)

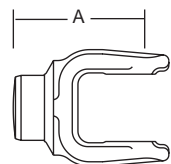

# 6 Series (cont'd.)

## Implement Yoke

### Round Bore

With Keyway & Set Screw

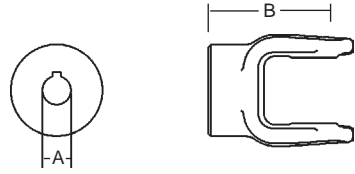

Stock Number	Dim. "A" Bore	Dim. "B"	Standard Keyway
800-0610	5/8"	2 1/2"	3/16"
800-0612	3/4"	2 1/2"	3/16"
800-0613	13/16"	2 1/2"	3/16"
800-0614	7/8"	2 1/2"	3/16"
800-0615	15/16"	2 1/2"	1/4"
800-0616	1"	2 1/2"	1/4"
800-0618	1 1/8"	2 1/2"	1/4"
800-0619	1 3/16"	2 1/2"	1/4"
800-0620	1 1/4"	2 1/2"	1/4"

### Square Bore

With Set Screw

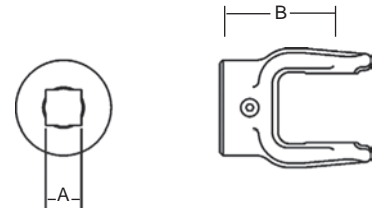

Stock Number	Dim. "A" Bore	Dim. "B"
804-0612	3/4"	2 1/2"
804-0614	7/8"	2 1/2"
804-0616	1"	2 1/2"
804-0618	1 1/8"	2 1/2"
804-0620	1 1/4"	2 1/2"

### Spline Bore

With 1/4" Pin Hole

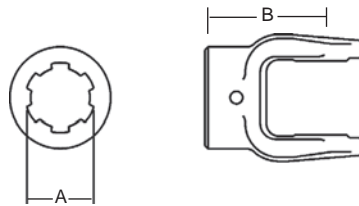

Stock Number	Dim. "A" Bore	Dim. "B"
801-0606	1 3/8" x 6 Spl.	2 1/2"
801-0618	1 1/8" x 6 Spl.	2 1/2"

### Round Bore

Double Keyway & Set Screw

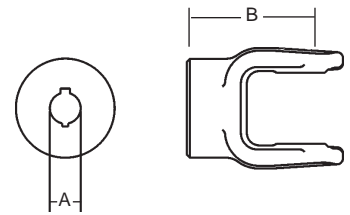

Stock Number	Dim. "A" Bore	Double Keyway	Dim. "B"
806-0612	3/4"	3/16" & 1/4"	2 1/2"
806-0613	13/16"	3/16" & 1/4"	2 1/2"
806-0614	7/8"	3/16" & 1/4"	2 1/2"
806-0616	1"	3/16" & 1/4"	2 1/2"
806-0618	1 1/8"	1/4" & 5/16"	2 1/2"
806-0619	1 3/16"	1/4" & 5/16"	2 1/2"
806-0620	1 1/4"	1/4" & 5/16"	2 1/2"

### Shear Pin

With 1/4" Pin Hole

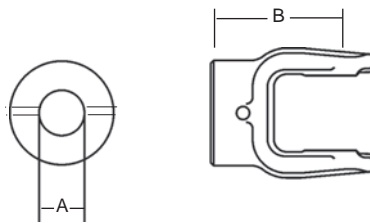

Stock Number	Dim. "A" Bore	Dim. "B"
802-0616	1"	2 1/2"
802-0618	1 1/8"	2 1/2"
802-0620	1 1/4"	2 1/2"

### Clamp Yoke

With Bolt Hole & Set Screw

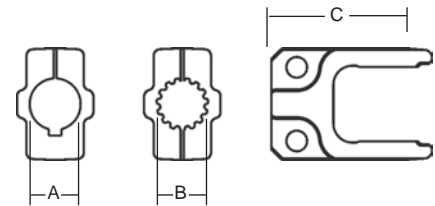

Stock Number	Dim. "A" Bore	Dim. "B" Bore	Keyway	Dim. "C"
807-0614	7/8"		3/16"	2 1/2"
807-0615		1" x 15 Spl.		2 1/2"
807-0616	1"		1/4"	2 1/2"

### Stock Bore

With Hub O. D. Turned

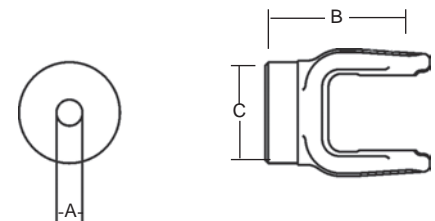

Stock Number	Dim. "A" Bore	Dim. "B"	Dim. "C"
809-0608	1/2"	2 1/2"	2"

## 6 Series (cont'd.)

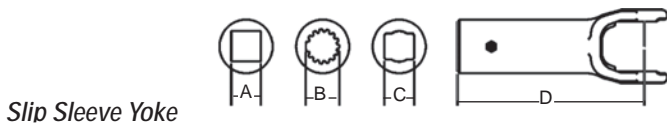

Slip Sleeve Yoke

Stock Number	Dim. "A" Bore	Dim. "B" Bore	Dim. "C" Bore	Dim. "D" Length
808-0612	3/4" Sq.			5 1/2"
808-0614	7/8" Sq.			5 1/2"
812-0615		1" x 15 Spl.		5 1/2"
813-0600			3/4" x 7/8" Rect.	5 1/2"

### Yoke & Tube Assembly

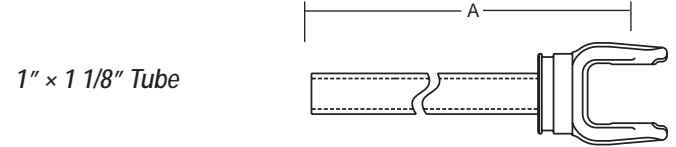

1" x 1 1/8" Tube

Stock Number	Fits Shaft	Dim. "A"
11000648	3/4" x 7/8"	38.75"

### Yoke & Shaft Assembly

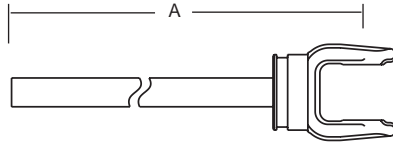

Stock Number	Shaft Size	Dim. "A"
10000610	1" x 15 Spl.	12.50"
10000648	3/4" x 7/8"	38.75"

### Guard

Order Bushings As Required

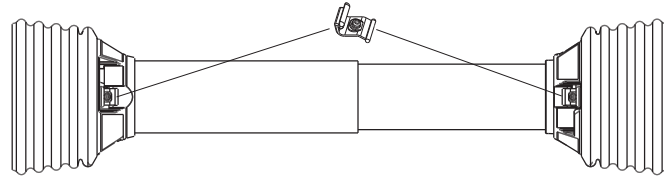

Stock Number	Overall Driveline Length	Bearing Kit (4-per kit)
900-2548	48"	921-0600
900-2560	60"	921-0600

Assembly instructions included with guard bearing kit

NOTE: Guards must rotate freely on yokes

### Easy Lock™ Replacement Kit

Part Number: 13005000 (4-per Kit)



### Guard Chain Kit

Part Number: 13006500 (2-per Kit)

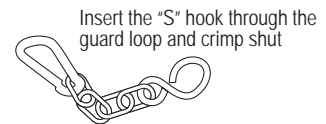



# 6 Series (cont'd.)

## Universal Joints

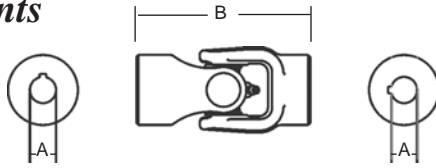

**Round To Round**  
Furnished with Keyway & Set Screw

Stock Number	Dim. "A" Bore	Dim. "B"
15120612	3/4"	5"
15160616	1"	5"

## Drivelines

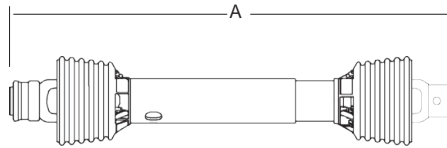

Drivelines are furnished without Cross & Bearing Kit and Implement Yoke. Select kit and Implement Yoke as required. When cross & bearing kit and implement yoke are assembled, the overall compressed length of the driveline will be 48".

Stock Number	Tractor Yoke	Overall Compressed Length Dim. "A"	Max Running Length
14000648	1 3/8" x 6 Spl. Spring Lok	48"	70"

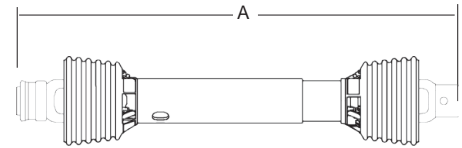

Drivelines are furnished without Cross & Bearing Kit and Outboard Yokes. Select kit and outboard yokes as required. When cross & bearing kit and outboard yokes are assembled, the overall compressed length of the driveline will be 48".

Stock Number	Overall Compressed Length Dim. "A"	Max Running Length
14010648	48"	70"

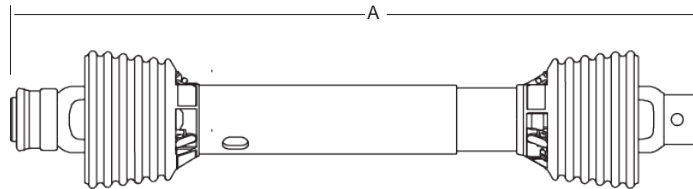

Stock Number	Tractor Yoke	Implement Yoke	Overall Compressed Length Dim. "A"	Max Running Length	Application
14000600	1 3/8" x 6 Spl. Spring Lok	1" Round with 1/2" Pin Hole	39"	60"	Finishing Mower
14000605	1 3/8" x 6 Spl. Spring Lok	1" Round with 5/16" Pin Hole	39"	60"	Finishing Mower
14000616	1 3/8" x 6 Spl. Spring Lok	1" Round 1/4" Keyway	48"	70"	Auger
14000620	1 3/8" x 6 Spl. Spring Lok	1 3/8" x 6 Spl. Spring Lok	27 1/4"	36"	Fertilizer Spreader
14000638	1 3/8" x 6 Spl. Q.D.	1" Round with 3/8" Pinhole	38"	55"	Finishing Mower

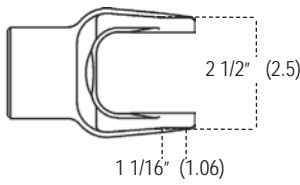

# 12 Series

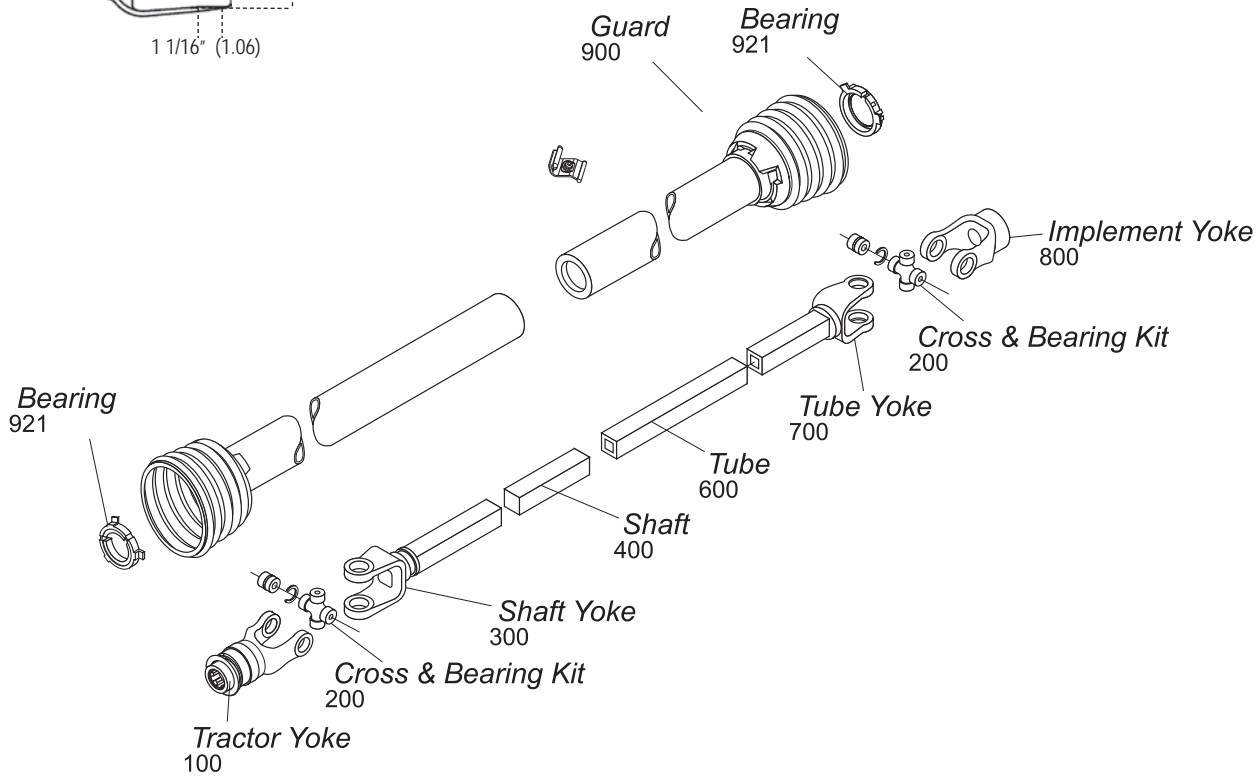

## Tractor Yoke

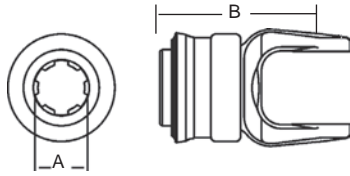

**Spring-Lok**  
Repair Kit — 13003100

Stock Number	Dim. "A" Bore	Dim. "B"
100-1206	1 3/8" x 6 Spl.	4"
100-1221	1 3/8" x 21 Spl.	4"

**Ball Shear Device**  
With Spring-Lok  
Repair Kit — 13003100

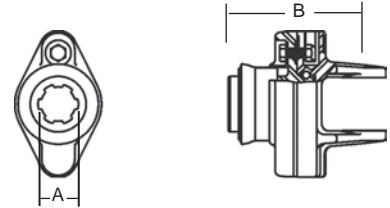

Stock Number	Dim. "A" Bore	Dim. "B"	Shear Bolt
104-1206	1 3/8" x 6 Spl.	4 5/8"	5/16" - 18 Gr. 5
104-1221	1 3/8" x 21 Spl.	4 5/8"	5/16" - 18 Gr. 5

Replacement Shear Bolt Part # 11-10128

**Quick Disconnect**  
Repair Kit —  
\*13002006  
\*\*13002021

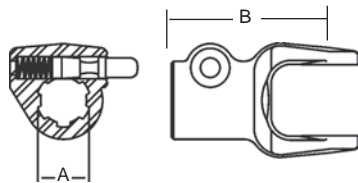

Stock Number	Dim. "A"	Dim. "B"
102-1206*	1 3/8" x 6 Spl.	4"
102-1221**	1 3/8" x 21 Spl.	4"

## Cross & Bearing Kit

**(R Kit)**  
(Recommended 8 hour grease interval)

Snap Ring Located in Bushing

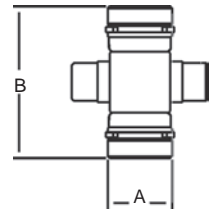

Stock Number	Dim. "A"	Dim. "B"
200-1200	1 1/16"	2 1/2"

## Extended Lubrication Cross & Bearing Kit

**(E Kit)**  
(Recommended 50 hour grease interval)

Snap Ring Located in Bushing

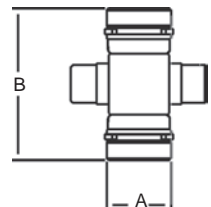

Stock Number	Dim. "A"	Dim. "B"
201-1200	1 1/16"	2 1/2"

# 12 Series (cont'd.)

## Shaft Weld Yoke

With bearing groove  
(Guard must rotate freely on yoke)

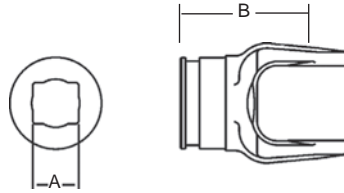

Stock Number	Dim. "A" Bore	Dim. "B"
300-1200	1" x 1 1/8"	3 3/8"
301-1200*	15/16" Sq.	2 3/4"

\*Requires nylon bearing 04-15170

## Shaft



1" x 1 1/8" Rectangular

Stock Number	Length
400-1618	6'
404-1618	3'

## Slip Sleeve

With Grease Groove

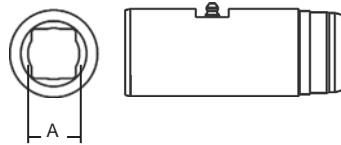

Stock Number	Dim. "A" Bore	Length	Fits Tube Size
500-1400	1" x 1 1/8" Rect.	5"	2" (.083 Wall)

## Tube

1 1/4" x 1 3/8"  
Rectangular O.D.



Stock Number	Length	Fits Shaft
600-2022	6'	1" x 1 1/8"
604-2022	3'	1" x 1 1/8"

2" (.083 Wall)



Stock Number	Length
602-1400	6'
604-1400	3'

## Tube Weld Yoke

With bearing groove  
(Guard must rotate freely on yoke)

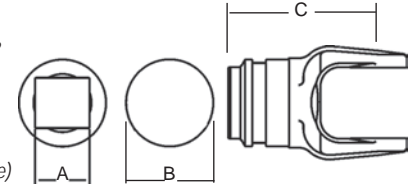

Stock Number	Dim. "A" Bore	Dim. "B" Fits Tube Size	Dim. "C"
700-1200	1 1/4" x 1 3/8"		3 3/8"
701-1200		2" (.083 Wall)	3 7/8"
702-1200*	15/16" Sq.		2 3/4"

\*Requires nylon bearing 04-15170

## Implement Yoke

Round Bore

With Keyway & Set Screw

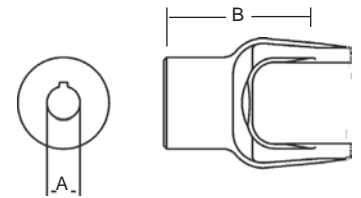

Stock Number	Dim. "A" Bore	Dim. "B"	Standard Keyway
800-1212	3/4"	3 1/2"	3/16"
800-1214	7/8"	3 1/2"	3/16"
800-1215	15/16"	3 1/2"	1/4"
800-1216	1"	3 1/2"	1/4"
800-1218	1 1/8"	3 1/2"	1/4"
800-1219	1 3/16"	3 1/2"	1/4"
800-1220	1 1/4"	3 1/2"	1/4"
800-1222	1 3/8"	3 1/2"	5/16"
800-1224	1 1/2"	3 7/8"	3/8"

Spline Bore

With 21/64" Pin Hole

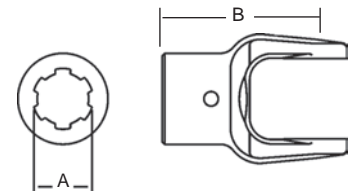

Stock Number	Dim. "A" Bore	Dim. "B"
801-1206	1 3/8" x 6 Spl.	3 1/2"
801-1210*	1 3/16" x 10 Spl.	3 1/2"
801-1213	.90" x 13 Spl. w/Set Screw	3 1/2"
801-1218	1 1/8" x 6 Spl.	3 1/2"
801-1221	1 3/8" x 21 Spl.	3 1/2"

\*No Pin Hole with machined seal surface

Shear Pin

With 1/4" Pin Hole

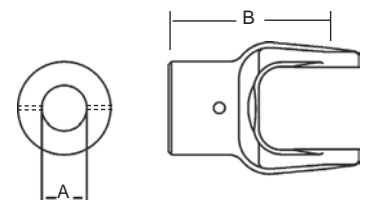

Stock Number	Dim. "A" Bore	Dim. "B"
802-1216	1"	3 1/2"
802-1218	1 1/8"	3 1/2"
802-1220	1 1/4"	3 1/2"
802-1222	1 3/8"	3 1/2"

## 12 Series (cont'd.)

### Square Bore With Set Screw

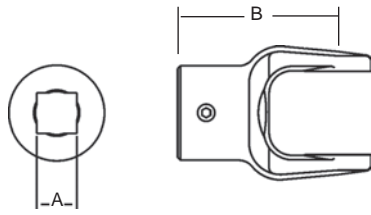

Stock Number	Dim. "A" Bore	Dim. "B"
804-1214	7/8"	3 1/2"
804-1216	1"	3 1/2"
804-1218	1 1/8"	3 1/2"
804-1220	1 1/4"	3 7/8"

### Hexagon Bore With Set Screw

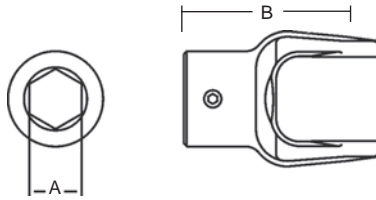

Stock Number	Dim. "A" Bore	Dim. "B"
805-1218	1 1/8"	3 1/2"
805-1220	1 1/4"	3 1/2"

### Round Bore Double Keyway & Set Screw

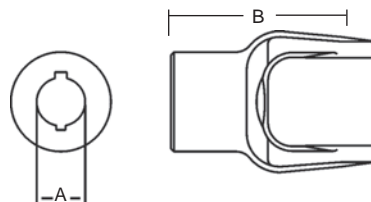

Stock Number	Dim. "A" Bore	Dim. "B"	Double Keyway
806-1216	1"	3 1/2"	1/4" & 3/16"
806-1218	1 1/8"	3 1/2"	1/4" & 5/16"
806-1220	1 1/4"	3 1/2"	1/4" & 5/16"

### Stock Bore With Hub O.D. Turned

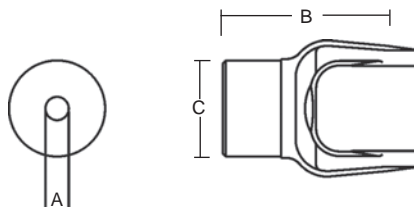

Stock Number	Dim. "A" Bore	Dim. "B"	Dim. "C"
809-1208	1/2"	3 1/2"	2"

## Guard

Order Bearings as Required

Stock Number	Overall Driveline Length	Bearing Kit (4-per kit)
900-2548	48"	921-1200
900-2560	60"	921-1200

Assembly instructions included with guard bearing kit  
NOTE: Guards must rotate freely on yokes

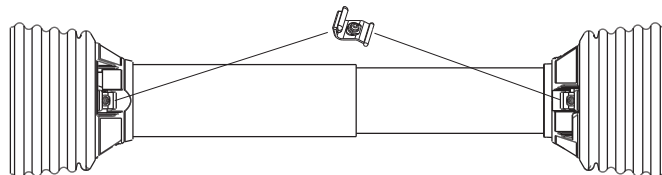

## Slip Yoke

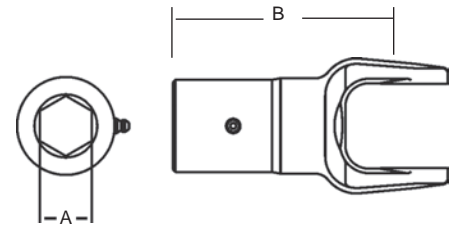

Stock Number	Dim. "A" Bore	Dim. "B"
808-1216	1" Sq.	5 1/4"
810-1216	1" Rd. w/1/4" Keyway	5 1/4"
811-1218	1 1/8" Hex	5 1/4"

## Yoke & Shaft Assembly

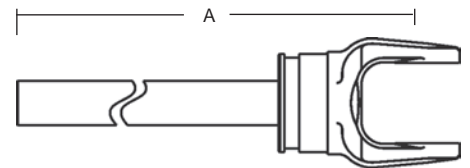

1" x 1 1/8"  
Rectangular Shaft

Stock Number	Dim. "A"
10001248	37.38"
10001260	49.38"

## Yoke & Tube Assembly

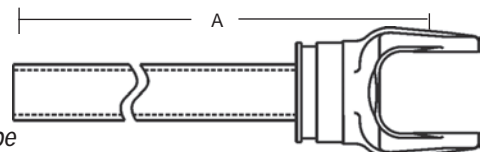

1 1/4" x 1 3/8" Tube

Stock Number	Fits Shaft	Dim. "A"
11001248	1" x 1 1/8"	37.38"
11001260	1" x 1 1/8"	49.38"

## Guard Chain Kit

Insert the "S" hook through the guard loop and crimp shut



Part Number: 13006500 (2-per Kit)

## Easy Lock™ Replacement Kit

Part Number: 13005000 (4-per Kit)



# 12 Series (cont'd.)

## Universal Joint

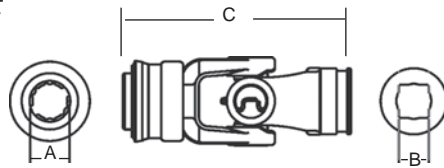

### Spring Lok to Shaft Weld Yoke

Repair Kit — 13003100

Stock Number	Dim. "A" Bore	Dim. "B" Bore	Dim. "C"
15061200	1 3/8" x 6 Spl.	1" x 1 1/8" Rect.	7 1/2"

## Drivelines

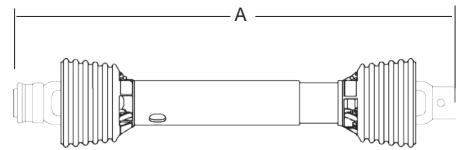
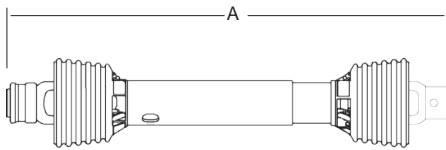

Drivelines are furnished without Cross & Bearing Kit and Implement Yoke. Select kit and implement yoke as required. When cross & bearing kit and implement yoke are assembled, the overall compressed length of the driveline will be 48" or 60".

Drivelines are furnished without Cross & Bearing Kit and Outboard Yokes. Select kit and outboard yokes as required. When cross & bearing kit and outboard yokes are assembled, the overall compressed length of the driveline will be 48" or 60".

Stock Number	Tractor Yoke	Overall Compressed Length Dim. "A"	Max Running Length
14001248	1 3/8" x 6 Spl. Spring Lok	48"	78"
14001260	1 3/8" x 6 Spl. Spring Lok	60"	89"

Stock Number	Overall Compressed Length Dim. "A"	Max Running Length
14011248	48"	78"
14011260	60"	89"
14021248 (with crosses installed)	48"	78"
14031248 (with 15/16" Sq. Shaft)	48"	78"

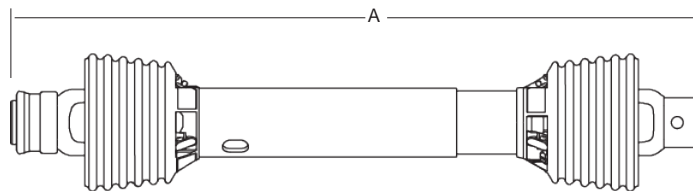

Stock Number	Tractor Yoke	Implement Yoke	Overall Compressed Length Dim. "A"	Max. Running Length	Application
14001200	1 3/8" x 6 Spl Q.D.	1 1/4" Rd 1/4" Keyway	48"	78"	Post Hole Digger
14001220	1 3/8" x 6 Spl. Spring Lok	1 1/4" Rd 1/4" Keyway	48"	77"	Augers

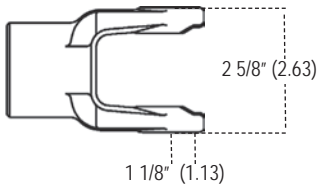

# 14 Series

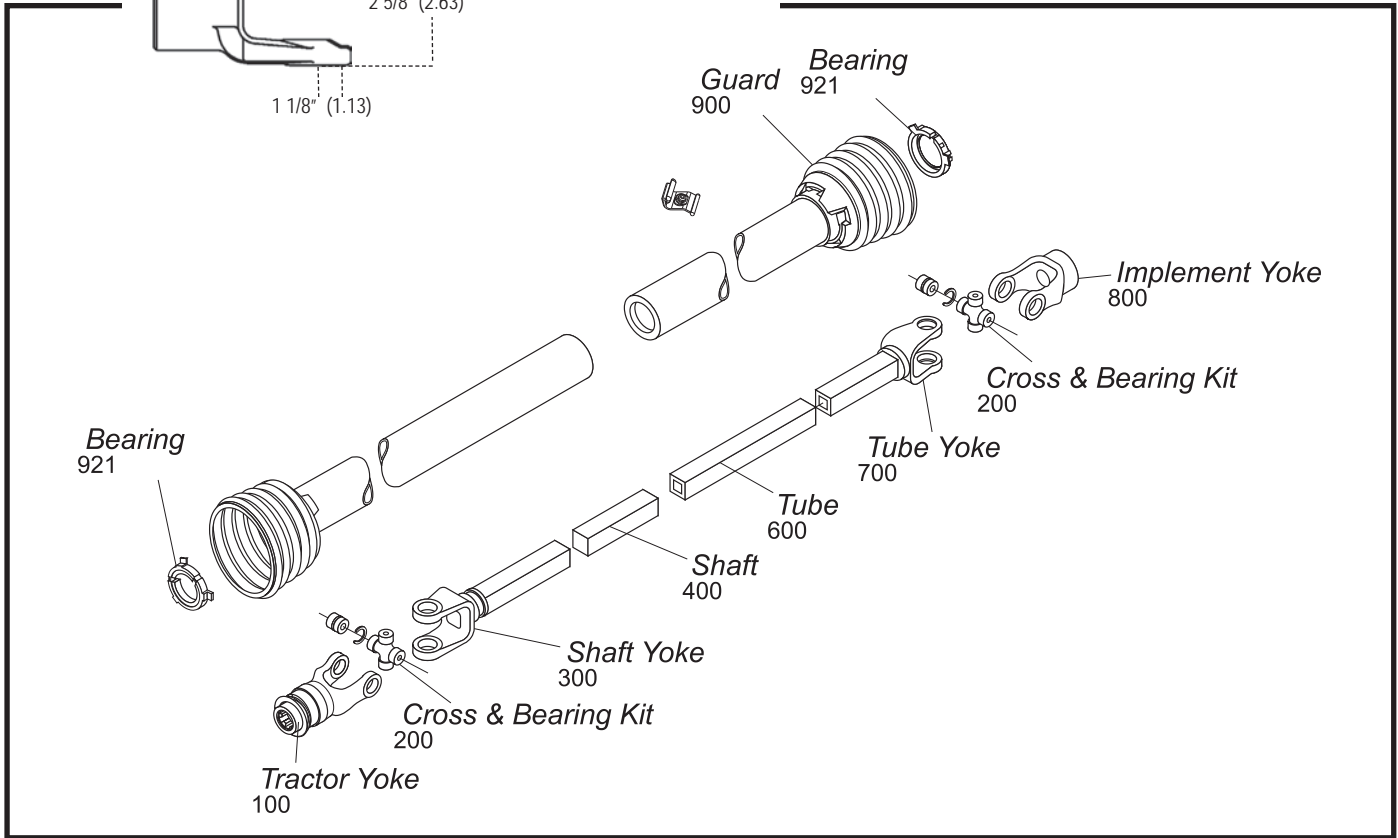

## Tractor Yoke

**Spring-Lok**  
Repair Kit — 13003100

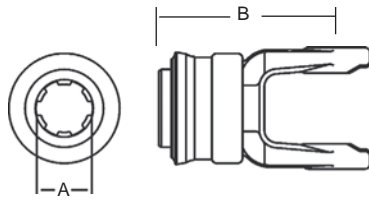

Stock Number	Dim. "A" Bore	Dim. "B"
100-1406	1 3/8" x 6 Spl.	4 5/16"
100-1421	1 3/8" x 21 Spl.	4 5/16"

**Quick Disconnect**  
Repair Kit —  
\*13002006  
\*\*13002021

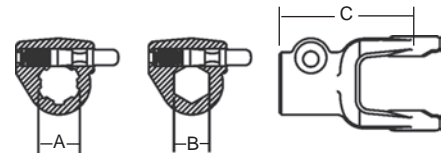

Stock Number	Dim. "A" Bore	Dim. "B" Bore	Dim. "C"
102-1406*	1 3/8" x 6 Spl.		4 5/16"
102-1418**		1 1/8" Hex	4 5/16"
102-1421**	1 3/8" x 21 Spl.		4 5/16"

**Safety Slide Lock**  
Repair Kit — 13004020

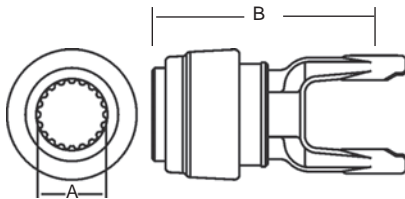

Stock Number	Dim. "A" Bore	Dim. "B"
101-1420	1 3/4" x 20 Spl.	5 5/8"

**Ball Shear Device**  
With Spring-Lok  
Repair Kit — 13003100

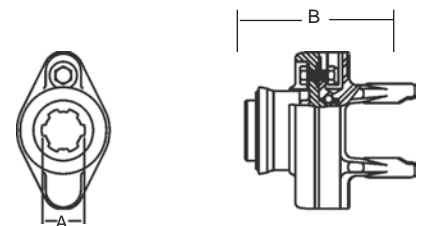

Stock Number	Dim. "A" Bore	Dim. "B"	Shear Bolt
104-1406	1 3/8" x 6 Spl.	4 5/8"	5/16" - 18 Gr. 5
104-1421	1 3/8" x 21 Spl.	4 5/8"	5/16" - 18 Gr. 5

Replacement Shear Bolt Part # 11-10128

# 14 Series (cont'd.)

## Cross & Bearing Kit

(R Kit)

(Recommended 8 hour grease interval)

Snap Ring Located in Yoke

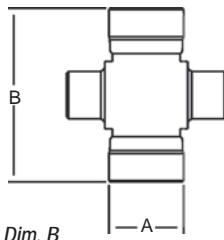

Stock Number	Dim. A	Dim. B
200-1400	1 1/8"	2 5/8"

## Extended Lubrication Cross & Bearing Kit

(E Kit)

(Recommended 50 hour grease interval)

Snap Ring Located in Yoke

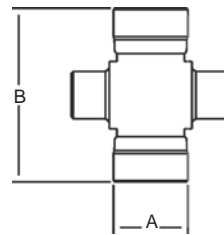

Stock Number	Dim. "A"	Dim. "B"
201-1400	1 1/8"	2 5/8"

## Shaft Weld Yoke

With Bearing Groove  
(Guard must rotate freely on yoke)

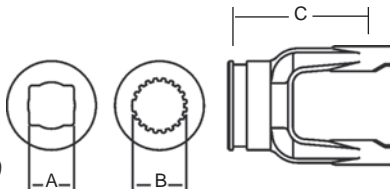

Stock Number	Dim. "A" Bore	Dim. "B" Bore	Dim. "C"
300-1400	1" x 1 1/8"		3 3/8"
301-1400		1 5/16" x 20 Spl.	3 3/8"

## Shaft



1" x 1 1/8" Rectangular

Stock Number	Length
400-1618	6'
404-1618	3'

1 5/16" x 20 Spline  
Induction Hardened



Stock Number	Length	Major Dim.
404-2120	3'	1.380/1.375

## Slip Sleeve

1" x 1 1/8" Rectangular  
With Grease Groove

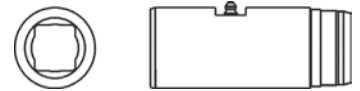

Stock Number	Length	Fits Tube Size
500-1400	5"	2" (.083 Wall)

1 5/16" x 20 Spline  
With Grease Reservoir



Stock Number	Length	Fits Tube Size
501-1400	8"	2" (.083 Wall)

## Tube

1 1/4" x 1 3/8"  
Rectangular O.D.



Stock Number	Length	Fits Shaft
600-2022	6'	1" x 1 1/8"
604-2022	3'	1" x 1 1/8"

2" Round (.083 Wall)



Stock Number	Length
602-1400	6'
604-1400	3'

## Tube Weld Yoke

With Bearing Groove  
(Guard must rotate freely on yoke)

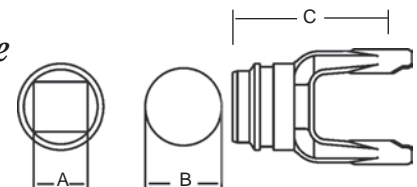

Stock Number	Dim. "A" Bore	Dim. "B" Fits Tube Size	Dim. "C"
700-1400	1 1/4" x 1 3/8"		3 3/8"
701-1400		2" (.083 Wall)	3 7/8"

**Implement Yoke**

**Round Bore**  
With Keyway & Set Screw

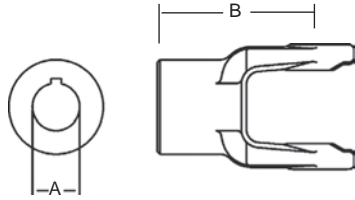

**Square Bore**  
With Set Screw

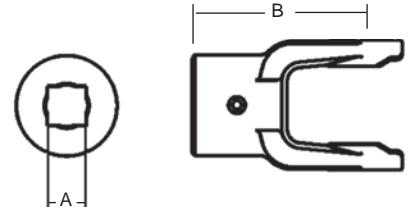

Stock Number	Dim. "A" Bore	Dim. "B"	Standard Keyway
800-1416	1"	3 7/8"	1/4"
800-1418	1 1/8"	3 7/8"	1/4"
800-1419	1 3/16"	3 7/8"	1/4"
800-1420	1 1/4"	3 7/8"	1/4"
800-1422	1 3/8"	3 7/8"	5/16"
800-1423	1 7/16"	3 7/8"	3/8"
800-1424	1 1/2"	3 7/8"	3/8"

Stock Number	Dim. "A" Bore	Dim. "B"
804-1414	7/8"	3 7/8"
804-1416	1"	3 7/8"
804-1418	1 1/8"	3 7/8"
804-1419	1 3/16"	3 7/8"
804-1420	1 1/4"	3 7/8"

**Spline Bore**  
With 21/64" Pin Hole

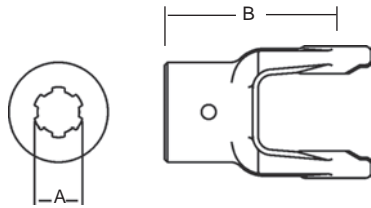

**Hexagon Bore**  
With Set Screw

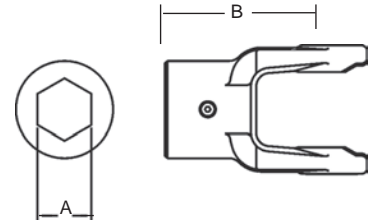

Stock Number	Dim. "A" Bore	Dim. "B"
801-1406	1 3/8" x 6 Spl.	3 7/8"
801-1418	1 1/8" x 6 Spl.	3 7/8"
801-1420	1 1/4" x 6 Spl.	3 7/8"
801-1421	1 3/8" x 21 Spl.	3 7/8"

Stock Number	Dim. "A" Bore	Dim. "B"
805-1418	1 1/8"	3 7/8"
805-1420	1 1/4"	3 7/8"

**Shear Pin**  
With 1/4" Pin Hole

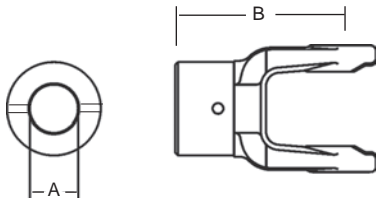

**Round Bore**  
Double Keyway & Set Screw

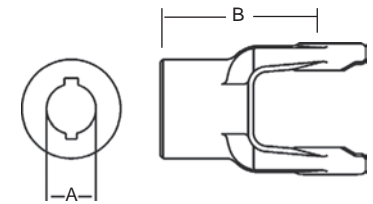

Stock Number	Dim. "A" Bore	Dim. "B"
802-1418	1 1/8"	3 7/8"
802-1420	1 1/4"	3 7/8"
802-1422*	1 3/8"	3 7/8"
802-1424	1 1/2"	3 7/8"

Stock Number	Dim. "A" Bore	Double Keyway	Dim. "B"
806-1418	1 1/8"	1/4" & 5/16"	3 7/8"
806-1419	1 3/16"	1/4" & 5/16"	3 7/8"
806-1420	1 1/4"	1/4" & 5/16"	3 7/8"

\* with 1/4" and 1/2" Pin Hole

**Torque Limiter Flange**  
(Interchanges with Great Lakes Clutch)

Stock Number	Dim. "A"
803-1400	4 1/2"

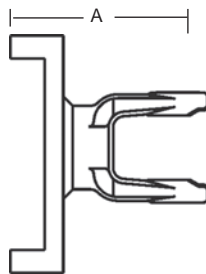

**Stock Bore**  
With Hub O. D. Turned

Stock Number	Dim. "A" Bore	Dim. "B"	Dim. "C"
809-1412	3/4"	3 7/8"	2 1/8"

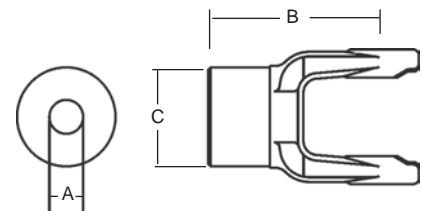



# 14 Series (cont'd.)

## Guard

Order Bearings As Required

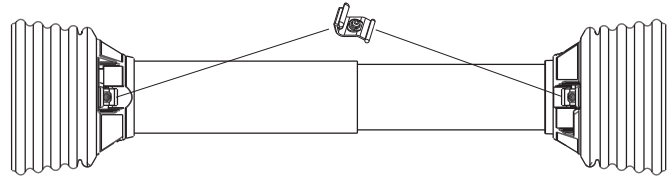

Stock Number	Overall Driveline Length	Bearing Kit (4-per kit)
900-2548	48"	921-1200
900-2560	60"	921-1200

Assembly instructions included with guard bearing kit  
NOTE: Guards must rotate freely on yokes

## Yoke & Shaft Assembly

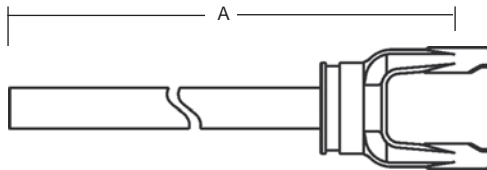

1" x 1 1/8" Shaft

Stock Number	Dim. "A"
10001438	26.12"
10001448	35.62"
10001460	47.62"

## Yoke, Tube & Sleeve Assembly

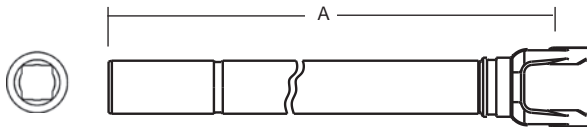

1" x 1 1/8" Rectangular

Stock Number	Dim. "A"
11001438	26.12"
11001448	36.12"
11001460	48.12"

## Easy Lock™ Replacement Kit

Part Number: 13005000 (4-per Kit)



## Guard Chain Kit

Insert the "S" hook through the guard loop and crimp shut



Part Number: 13006500 (2-per Kit)

## Universal Joint

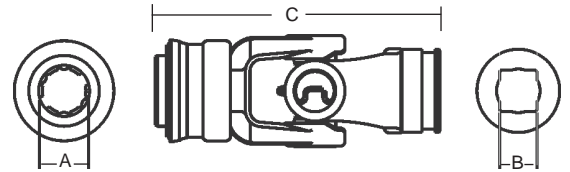

Spring-Lok to Shaft Weld Yoke  
Repair Kit — 13003100

Stock Number	Dim. "A" Bore	Dim. "B" Bore	Dim. "C"
15061400	1 3/8" x 6 Spl.	1" x 1 1/8" Rect.	7 3/4"

## Drivelines

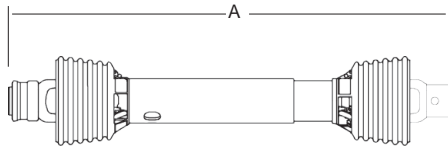

Drivelines are furnished without Cross & Bearing Kit and Implement Yoke. Select kit and implement yoke as required. When cross & bearing kit and implement yoke are assembled, the overall compressed length of the driveline will be 48" or 60".

Stock Number	Tractor Yoke	Overall Compressed Length Dim. "A"	Max. Running Length
14001448	1 3/8" x 6 Spl. Spring Lok	48"	75"
14001460	1 3/8" x 6 Spl. Spring Lok	60"	99"

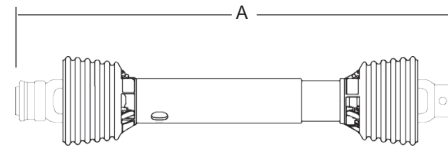

Drivelines are furnished without Cross & Bearing Kit and Outboard Yoke. Select kit and outboard yokes as required. When cross & bearing kit and outboard yokes are assembled, the overall compressed length of the driveline will be 48" or 60".

Stock Number	Overall Compressed Length Dim. "A"	Max. Running Length
14011448	48"	75"
14011460	60"	99"
14021448 (With crosses installed)	48"	75"

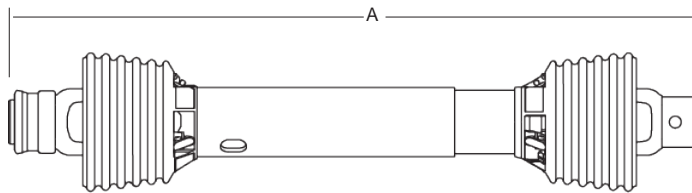

Stock Number	Tractor Yoke	Implement Yoke	Overall Compressed Length Dim. "A"	Max. Running Length	Application
14001404	1 3/8" x 6 Spl. Spring-Lok	1 3/8" Round 1/2" Shear Pin Hole	30 3/16"	39.5"	4 ft. Lift Type Rotary Cutter
14001405	1 3/8" x 6 Spl. Spring-Lok	1 3/8" Round 1/2" Shear Pin Hole	37 3/16"	53.5"	5 ft. Lift Type Rotary Cutter
14001406	1 3/8" x 6 Spl. Spring-Lok	1 3/8" Round 1/2" Shear Pin Hole	56 3/16"	76.5"	5 & 6 ft. Pull Type Rotary Cutter
14001420	1 3/8" x 6 Spl. Spring-Lok	1 1/4" Round 1/4" Keyway	48"	75"	Auger

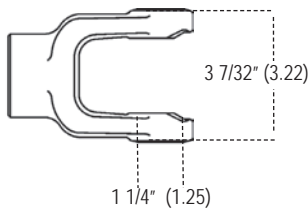

# 35 Series

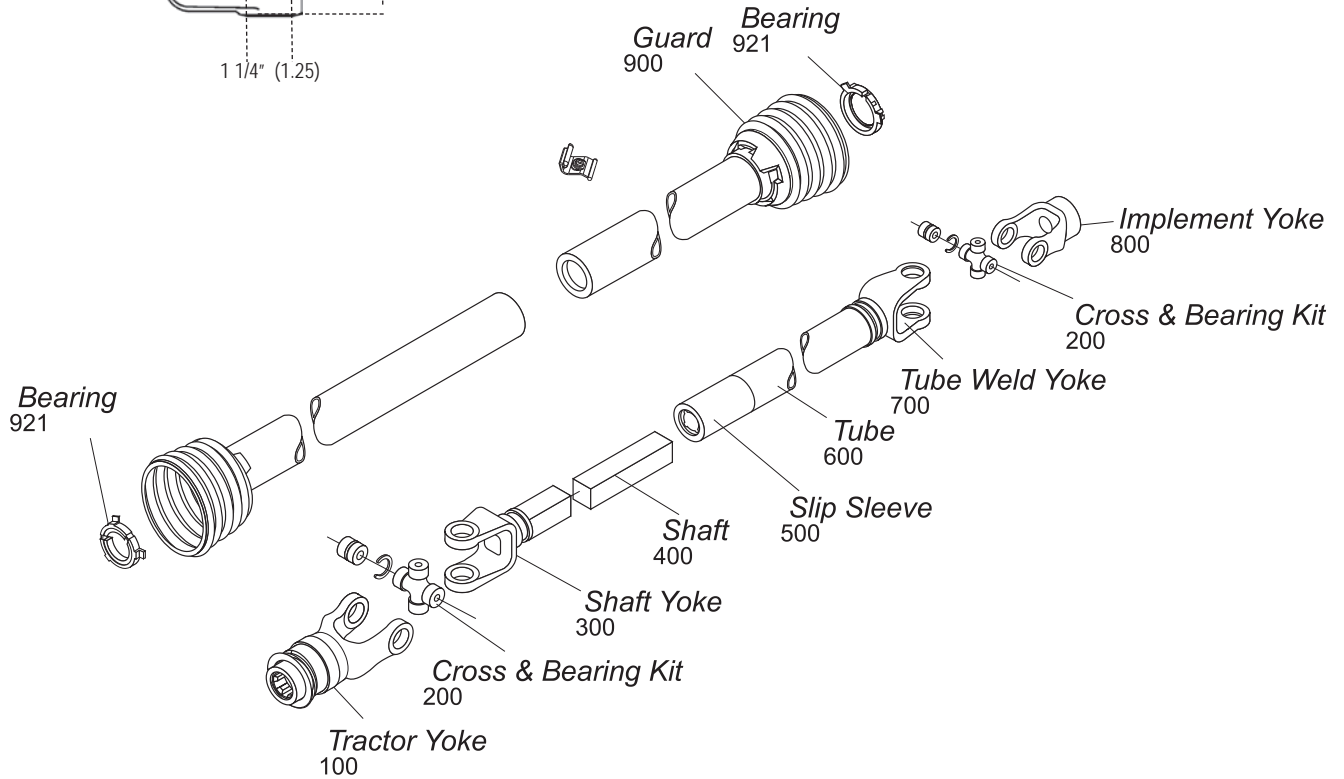

## Tractor Yoke

### Safety Slide Lock

Repair Kit —  
\*13004000  
\*\*13004020

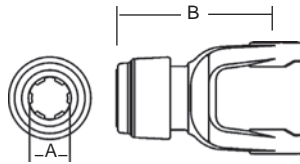

Stock Number	Dim. "A" Bore	Dim. "B"
101-3506*	1 3/8" x 6 Spl.	5 1/4"
101-3520**	1 3/4" x 20 Spl.	6 1/8"
101-3521*	1 3/8" x 21 Spl.	5 1/4"

### Ball Shear Device

With Safety Slide Lock  
Repair Kit —  
\*13004000  
\*\*13004020

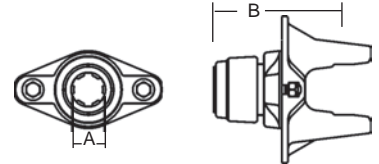

Stock Number	Dim. "A" Bore	Shear Bolt	Dim. "B"
104-3506*	1 3/8" x 6 Spl.	(2) 3/8" - 16 Gr. 5	5 1/2"
104-3520**	1 3/4" x 20 Spl.	(2) 3/8" - 16 Gr. 5	6"
104-3521*	1 3/8" x 21 Spl.	(2) 3/8" - 16 Gr. 5	5 1/2"
104-3524	1 1/2" Rd. 3/8" Kw.	(2) 3/8" - 16 Gr. 5	6"

### Replacement Shear Bolt Part No. 11-10445

### Quick Disconnect

Repair Kit —  
\*13002021  
\*\*13002006  
\*\*\*13002020  
\*\*\*\*13002806

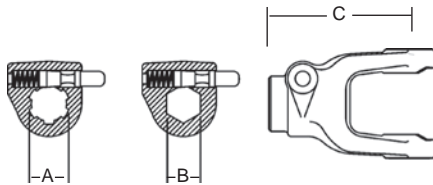

Stock Number	Dim. "A" Bore	Dim. "B" Bore	Dim. "C"
102-3505*		1 1/4" Hex	4 3/4"
102-3506**	1 3/8" x 6 Spl.		4 3/4"
102-3518*		1 1/8" Hex	4 3/4"
102-3520***	1 3/4" x 20 Spl.		5 3/8"
102-3521*	1 3/8" x 21 Spl.		4 3/4"
102-3528****	1 3/4" x 6 Spl.		5 5/16"

### Auto-Lok

Repair Kit —  
\*13004000  
\*\*13004020

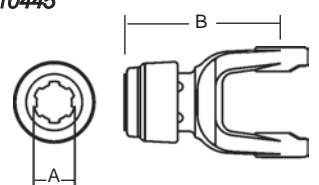

Stock Number	Dim. "A" Bore	Dim. "B"
110-3506*	1 3/8" x 6 Spl.	5 1/4"
110-3520**	1 3/4" x 20 Spl.	6 1/8"
110-3521*	1 3/8" x 21 Spl.	5 1/4"

## Cross & Bearing Kit

(R Kit)  
(Recommended 8 hour grease interval)

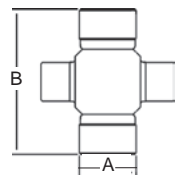

Snap Ring Located in Yoke

Stock Number	Dim. "A"	Dim. "B"
200-3500	1 1/4"	3 7/32"

## Extended Lubrication Cross & Bearing Kit (E Kit)

(Recommended 50 hour grease interval)

Snap Ring Located in Yoke

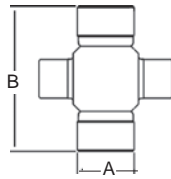

Stock Number	Dim. "A" Bore	Dim. "B"
201-3500	1 1/4"	3 7/32"

## Slip Sleeve

With Grease Groove

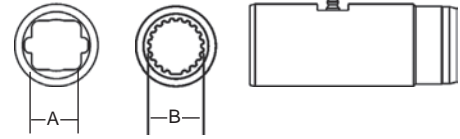

Stock Number	Length	Dim. "A" Bore	Dim. "B" Bore	Fits Tube Size
500-3500	5"	1 3/16" Sq.		2 1/8" (.120 Wall)
501-3500	5"	1 3/16" Sq.		2 1/8" (.083 Wall) & 2 1/4" (.120 Wall)
504-3500	8"	1 5/16" Sq.		2 1/2" (.120 Wall)
505-3500	5"		1 11/16" x 20 Spl.	2 1/2" (.120 Wall)

## Shaft Weld Yoke

With Bearing Groove

(Guard must rotate freely on yoke)

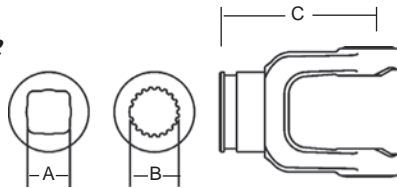

Stock Number	Dim. "A" Bore	Dim. "B" Bore	Dim. "C"
300-3500	1 3/16" Sq.		4 1/4"
301-3500		1 5/16" x 20 Spl.	4 1/4"
*302-3500		1 11/16" x 20 Spl.	3 3/4"

\* For use with 921-3500 Nylon Bearing Kit and 902-3548 / 902-3560 Guard

## Spline Sleeve

With Grease Reservoir

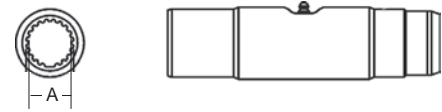

Stock Number	Length	Dim. "A" Bore	Fits Tube Size
502-3500	8"	1 5/16" x 20 Spl.	2 1/8" (.120 Wall)
503-3500	8"	1 11/16" x 20 Spl.	2 1/2" (.120 Wall)

## Shaft

1 3/16" Square



Stock Number	Length
400-0019	6'
404-0019	3'

## Tube



Stock Number	Dim. "A" Size	Length
602-3500	2 1/8" (.120 Wall)	6'
604-3500	2 1/8" (.120 Wall)	3'

## Tube Weld Yoke

With Bearing Groove  
(Guard must rotate freely on yoke)

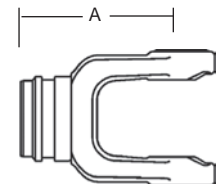

Stock Number	Dim. "A"	Fits Tube Size
701-3500	4 1/4"	2 1/8" (.120 Wall)
702-3500	4 1/4"	2 1/8" (.083 Wall)
703-3500 with Bore**	4 1/4"	2 1/4" (.120 Wall)
*704-3500 with Bore**	4 1/4"	2 1/2" (.120 Wall)
705-3500 with Bore**	4 1/4"	2 1/8" (.120 Wall)

\* For use with 921-3500 Nylon Bearing Kit and 902-3548 / 902-3560 Guard

\*\* Bore through for telescoping shaft

## Spline Shaft

Induction Hardened



Stock Number	Dim. "A" Size	Length	Major Dim.
404-2120	1 5/16" x 20 Spl.	3'	1.380/1.375
404-2720	1 11/16" x 20 Spl.	3'	1.790/1.785

# 35 Series (cont'd.)

## Implement Yoke

### Round Bore

With Keyway & Set Screw

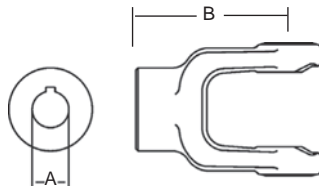

Stock Number	Dim. "A" Bore	Standard Keyway	Dim. "B"
800-3516	1"	1/4"	4 1/4"
800-3518	1 1/8"	1/4"	4 1/4"
800-3519	1 3/16"	1/4"	4 1/4"
800-3520	1 1/4"	1/4"	4 1/4"
800-3522	1 3/8"	5/16"	4 1/4"
800-3523	1 7/16"	3/8"	4 1/4"
800-3524	1 1/2"	3/8"	4 1/4"
8003524H	1 1/2"	3/8" with 5/16" Pinhole	4 1/4"
800-3528	1 3/4"	3/8"	4 1/4"
800-3526	1 5/8"	3/8"	4 1/4"

### Square Bore

With Set Screw

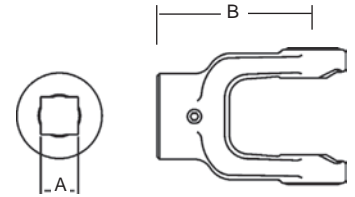

Stock Number	Dim. "A" Bore	Dim. "B"
804-3516	1"	4 1/4"
804-3518	1 1/8"	4 1/4"
804-3519	1 3/16"	4 1/4"
804-3520	1 1/4"	4 1/4"
804-3524	1 1/2"	4 1/4"

### Spline Bore

With 21/64" Pin Hole

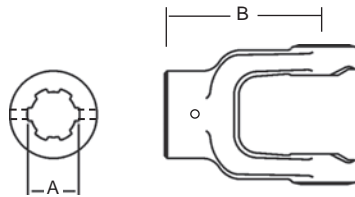

Stock Number	Dim. "A" Bore	Dim. "B"
801-3506	1 3/8" x 6 Spl.	4 1/4"
801-3521	1 3/8" x 21 Spl.	4 1/4"

### Round Bore

Double Keyway & Set Screw

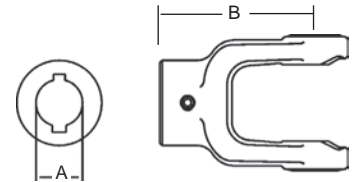

Stock Number	Dim. "A" Bore	Dim. "B"	Double Keyway
806-3519	1 3/16"	4 1/4"	1/4" & 5/16"
806-3520	1 1/4"	4 1/4"	1/4" & 5/16"
806-3522	1 3/8"	4 1/4"	5/16" & 3/8"

### Shear Pin

With 1/4" Pin Hole

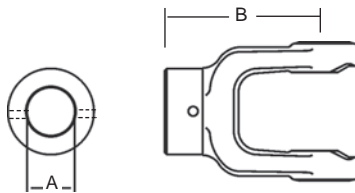

Stock Number	Dim. "A" Bore	Dim. "B"
802-3520	1 1/4"	4 1/4"
802-3522*	1 3/8"	4 1/4"
802-3524	1 1/2"	4 1/4"

\* With 1/2" Pin Hole.

### Clamp Yoke

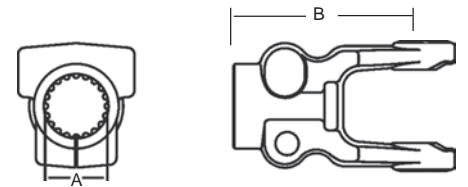

Stock Number	Dim. "A" Bore	Dim. "B"
807-3506	1 3/8" x 6 Spl.	4 3/4"
807-3520	1 3/4" x 20 Spl.	5 3/8"
807-3521	1 3/8" x 21 Spl.	4 3/4"
807-3527	1 3/4" x 27 Spl.	5 1/4"

### Torque Limiter Flange

(Interchanges with Great Lakes Clutch)

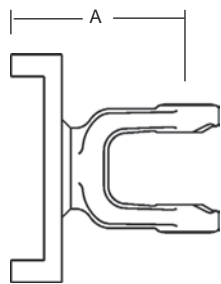

Stock Number	Dim. "A"
803-3500	5"

### Stock Bore

With Hub O. D. Turned

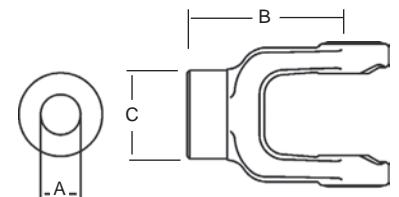

Stock Number	Dim. "A" Bore	Dim. "B"	Dim. "C"
809-3516	1"	4 1/4"	2 1/4"

**Guard**

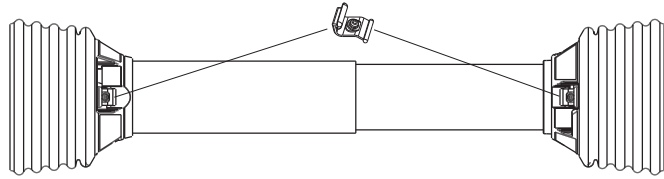

Order Bearings As Required

Stock Number	Overall Driveline Length	Bearing Kit (4-per kit)
900-2548	48"	921-1200
900-2560	60"	921-1200

Assembly instructions included with guard bearing kit  
 NOTE: Guards must rotate freely on yokes

**Easy Lock™ Replacement Kit**

Part Number: 13005000 (4-per Kit)



**Yoke & Shaft Assembly**

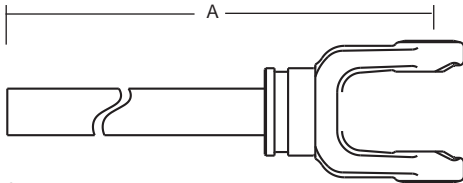

1 3/16" Square Shaft

Stock Number	Dim. "A"
10003531	17.69"
10003535	21.69"
10003542	28.69"
10003548	33.19"
10003560	44.94"

**Guard Chain Kit**

Insert the "S" hook through the guard loop and crimp shut



Part Number: 13006500 (2-per Kit)

**Universal Joint**

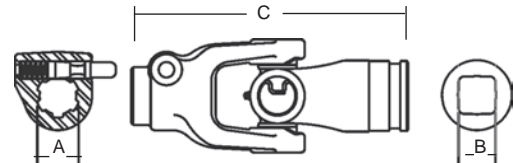

Quick Disconnect to Shaft Weld Yoke  
 Repair Kit — 13002006

Stock Number	Dim. "A" Bore	Dim. "B" Bore	Dim. "C"
15063500	1 3/8" × 6 Spl.	1 3/16" Sq.	8 7/8"

**Yoke, Tube & Sleeve Assembly**

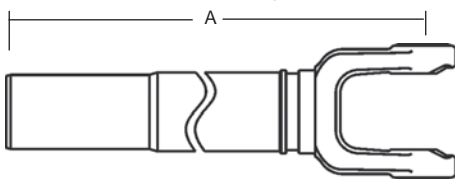

1 3/16" Square

Stock Number	Dim. "A"
11003531	17.69"
11003535	21.69"
11003543	29.69"
11003548	34.69"
11003560	46.69"

# 35 Series (cont'd.)

## Drivelines

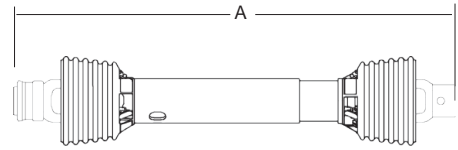
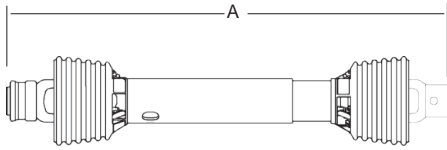

Drivelines are furnished without Cross & Bearing Kit and Implement Yoke. Select kit and yoke as required. When cross & bearing kit and yoke are assembled, the overall compressed length of the driveline will be 31", 35", 48" or 60".

Drivelines are furnished without Cross & Bearing Kit and Outboard Yokes. Select kit and outboard yokes as required. When cross & bearing kit and outboard yokes are assembled, the overall compressed length of the driveline will be 39", 48" or 60".

Stock Number	Tractor Yoke	Overall Compressed Length Dim. "A"	Max Running Length
14003531	1 3/8" x 6 Spl. Q.D.	31"	40"
14003535	1 3/8" x 6 Spl. Q.D.	35"	47"
14003548	1 3/8" x 6 Spl. Q.D.	48"	72"
14003560	1 3/8" x 6 Spl. Q.D.	60"	96"

Stock Number	Overall Compressed Length Dim. "A"	Max Running Length
14013548	48"	72"
14013560	60"	96"
14023539 (with crosses installed)	39"	51"
14023548 (with crosses installed)	48"	72"

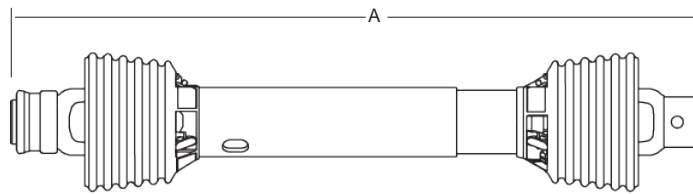

Stock Number	Tractor Yoke	Implement Yoke	Overall Compressed Length Dim. "A"	Max. Running Length	Application
14003507	1 3/8" x 6 Spl. Q.D.	1 3/8" Round 1/2" Shear Pin Hole	64 7/8"	88 7/8"	7 ft. Pull Type Rotary Cutter
14003524	1 3/8" x 6 Spl. Q.D.	1 1/2" Round 3/8" Keyway	48"	71 3/4"	Pumps
14003536	1 3/8" x 6 Spl. Safety Slide Lock	1 3/8" x 6 Spl. Safety Slide Lock	36"	47 3/4"	All Purpose
14013531	1 3/8" x 21 Spl. Safety Slide Lock	1 1/8" Hex Clamp	31"	44"	Combine Header

# 44 Series

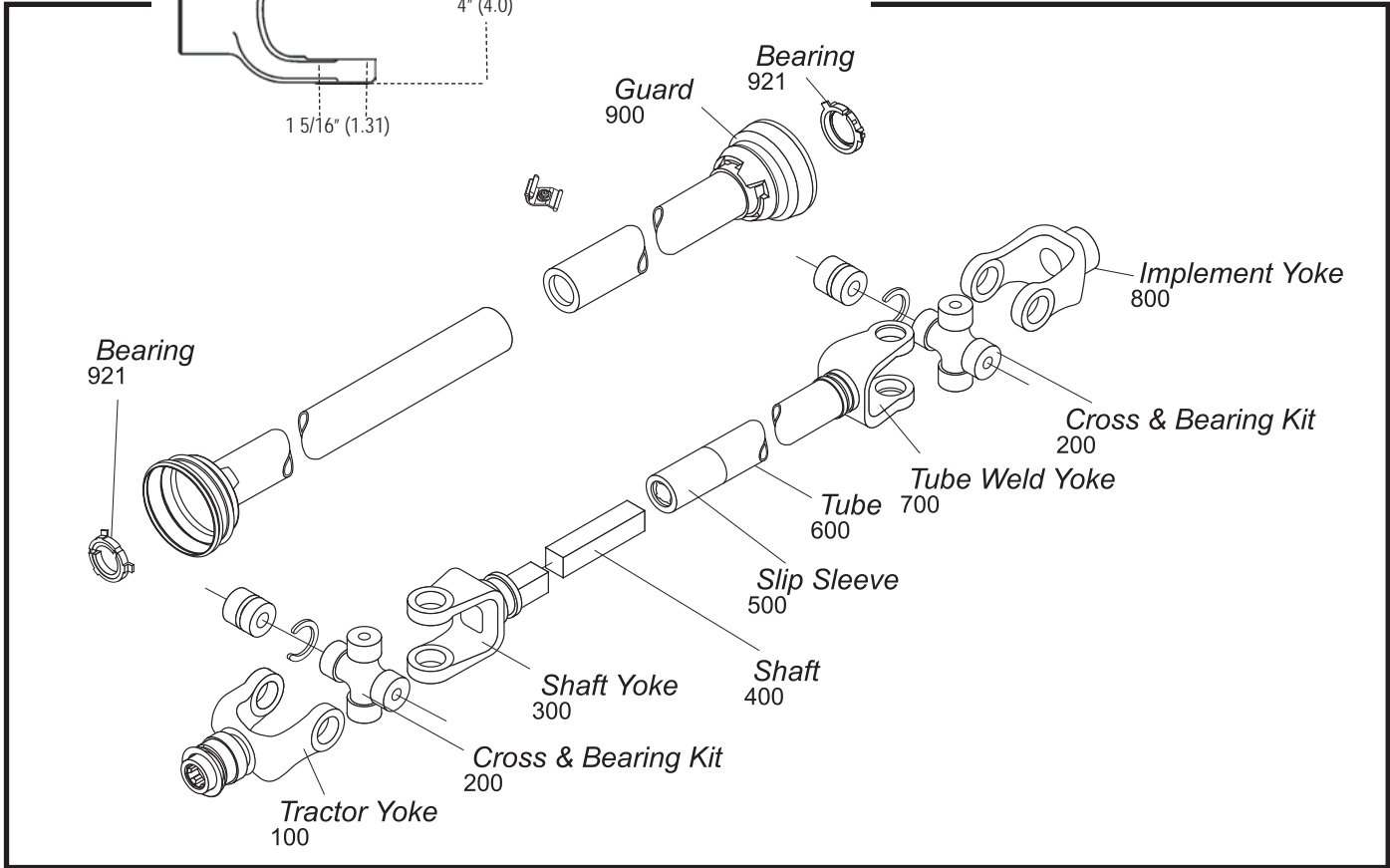

## Tractor Yoke

### Safety Slide Lock

Repair Kit —  
\*13004000  
\*\*13004020

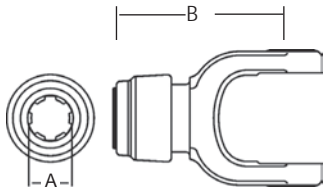

Stock Number	Dim. "A" Bore	Dim. "B"
101-4406*	1 3/8" × 6 Spl.	5 1/2"
101-4420**	1 3/4" × 20 Spl.	6 1/4"
101-4421*	1 3/8" × 21 Spl.	5 1/2"

### Ball Shear Device

With Safety Slide Lock  
Repair Kit —  
\*13004000  
\*\*13004020

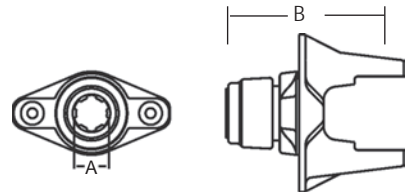

Stock Number	Dim. "A" Bore	Dim. "B"	Shear Bolt
104-4406*	1 3/8" × 6 Spl.	5 7/8"	(2) 3/8" x 16 Gr. 5
104-4420**	1 3/4" × 20 Spl.	5 3/8"	(2) 3/8" x 16 Gr. 5
104-4421*	1 3/8" × 21 Spl.	5 7/8"	(2) 3/8" x 16 Gr. 5

Replacement Shear Bolt Part # 11-10445

### Quick Disconnect

Repair Kit —  
\*13002006  
\*\*\*13002020  
\*\*\*\*13002021

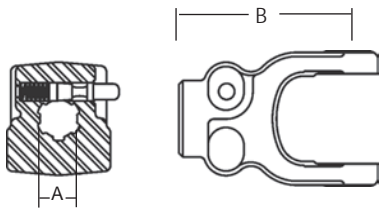

Stock Number	Dim. "A" Bore	Dim. "B"
102-4406*	1 3/8" × 6 Spl.	5 5/16"
102-4420**	1 3/4" × 20 Spl.	5 1/2"
102-4421***	1 3/8" × 21 Spl.	5 5/16"

### Auto-Lok

Repair Kit —  
\*13004000  
\*\*13004020

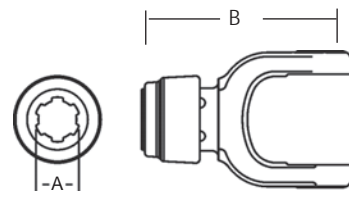

Stock Number	Dim. "A" Bore	Dim. "B"
110-4406*	1 3/8" × 6 Spl.	5 1/2"
110-4420**	1 3/4" × 20 Spl.	6 1/4"
110-4421*	1 3/8" × 21 Spl.	5 1/2"



# 44 Series (cont'd.)

## Cross & Bearing Kit (R-Kit)

(Recommended 8 hour grease interval)

Snap Ring Located in Bushing

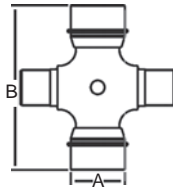

Stock Number	Dim. "A"	Dim. "B"
200-4400	1 5/16"	4"

## Extended Lubrication Cross & Bearing Kit (E-Kit)

(Recommended 50 hour grease interval)

Snap Ring Located in Bushing

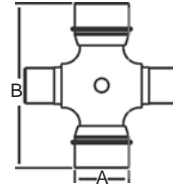

Stock Number	Dim. "A"	Dim. "B"
201-4400	1 5/16"	4"

## Shaft Weld Yoke

With Bearing Groove  
(Guard must rotate freely on yoke)

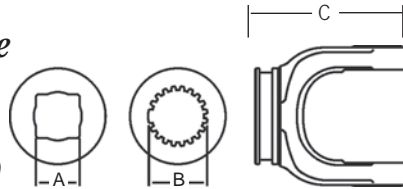

Stock Number	Dim. "A" Bore	Dim "B" Bore	Dim. "C"
300-4400	1 5/16" Sq.		4 1/8"
302-4400		1 11/16" x 20 Spl.	3 11/16"

## Shaft

1 5/16" Square



Stock Number	Length
400-0021	6'
404-0021	3'

## Slip Sleeve

With Grease Groove

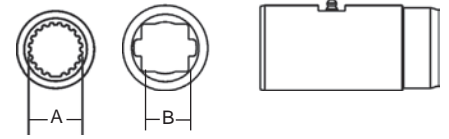

Stock Number	Length	Dim. "A"	Dim. "B"	Fits Tube Size.
500-4400	5"		1 5/16" Sq.	2 1/2" (.120 Wall)
505-3500	5"	1 11/16" x 20 Spl.		2 1/2" (.120 Wall)

With Grease Reservoir

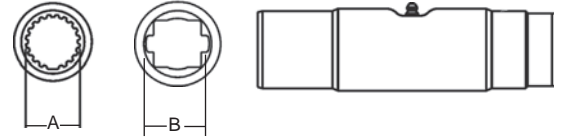

Stock Number	Length	Dim. "A"	Dim. "B"	Fits Tube Size.
503-3500	8"	1 11/16" x 20 Spl.		2 1/2" (.120 Wall)
504-3500	8"		1 5/16" Sq.	2 1/2" (.120 Wall)

## Tube

2 1/2" (.120 Wall)



Stock Number	Length
602-4400	6'
604-4400	3'

## Tube Weld Yoke

With Bearing Groove  
(Guard must rotate freely on yoke)

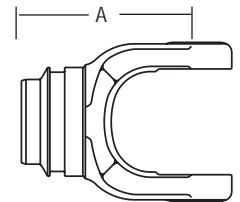

Stock Number	Dim. "A"	Fits Tube Size
701-4400	4 5/8"	2 1/2" (.120 Wall)
*702-4400 (with bore)	4 5/8"	2 1/2" (.120 wall)

\* Bore through for Telescoping

## Spline Shaft Induction Hardened



Stock Number	Dim.	Dim. "A"	Length	Major Dim.
404-2120		1 5/16" x 20 Spl.	3'	1.380/1.375
404-2720		1 11/16" x 20 Spl.	3'	1.790/1.785

## 44 Series (cont'd.)

### Implement Yoke

#### Round Bore

With Keyway & Set Screw

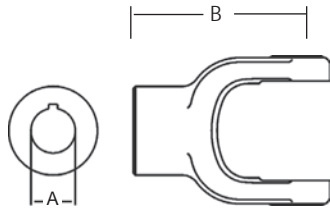

Stock Number	Dim. "A" Bore	Dim. "B"	Standard Keyway
800-4420	1 1/4"	4 5/8"	1/4"
800-4422	1 3/8"	4 5/8"	5/16"
800-4423	1 7/16"	4 5/8"	3/8"
800-4424	1 1/2"	4 5/8"	3/8"
800-4426	1 5/8"	4 5/8"	3/8"
800-4428	1 3/4"	4 5/8"	3/8"
800-4432	2"	4 5/8"	1/2"

#### Round Bore

Double Keyway & Set Screw

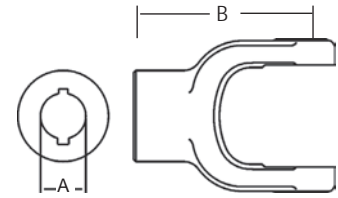

Stock Number	Dim. "A" Bore	Dim. "B"	Double Keyway
806-4420	1 1/4"	4 5/8"	5/16" & 1/4"
806-4422	1 3/8"	4 5/8"	5/16" & 1/4"
806-4424	1 1/2"	4 5/8"	5/16" & 3/8"

#### Spline Bore

With 21/64" Pin Hole

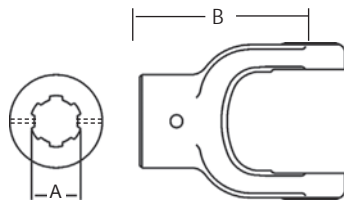

Stock Number	Dim. "A" Bore	Dim. "B"
801-4406	1 3/8" x 6 Spl.	4 5/8"
801-4421	1 3/8" x 21 Spl.	4 5/8"

#### Clamp Yoke

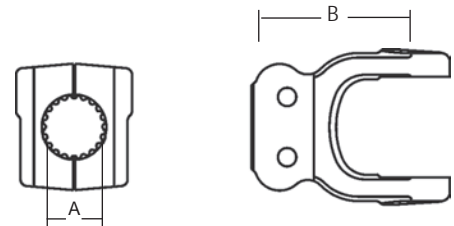

Stock Number	Dim. "A" Bore	Dim. "B"
807-4406	1 3/8" x 6 Spl.	4 5/8"
807-4420	1 3/4" x 20 Spl.	4 5/8"
807-4421	1 3/8" x 21 Spl.	4 5/8"
807-4427	1 3/4" x 27 Spl.	5"

#### Torque Limiter Flange

(Interchanges with Great Lakes Clutch)

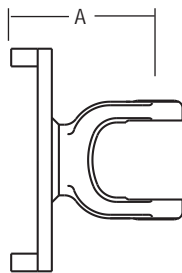

Stock Number	Dim. "A"
803-4400	5 1/8"

#### Stock Bore

With Hub O. D. Turned

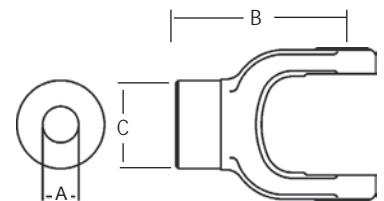

Stock Number	Dim. "A" Bore	Dim. "B"	Dim. "C"
809-4416	1"	4 5/8"	2 1/2"

#### Square Bore

With Set Screw

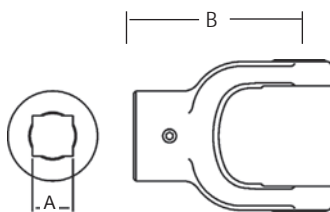

Stock Number	Dim. "A" Bore	Dim. "B"
804-4418	1 1/8"	4 5/8"

# 44 Series (cont'd.)

## Guard

\* Order Bearings as Required

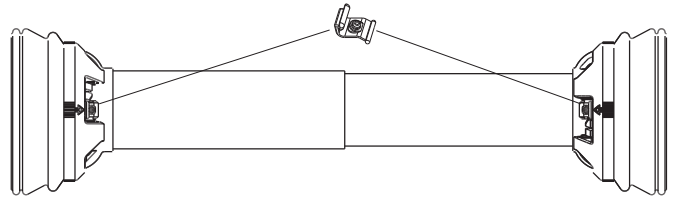

Stock Number	Overall Driveline Length	Bearing Kit (2-per kit)
902-3548	48"	921-4400
902-3560	60"	921-4400

Assembly instructions included with guard bearing kit  
NOTE: Guards must rotate freely on yokes

## Guard Chain Kit

Part Number: 13006500 (2-per Kit)

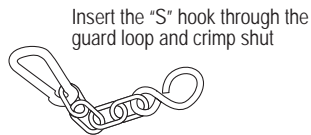

## Easy Lock™ Replacement Kit

Part Number: 13005000 (4-per Kit)



## Yoke & Shaft Assembly

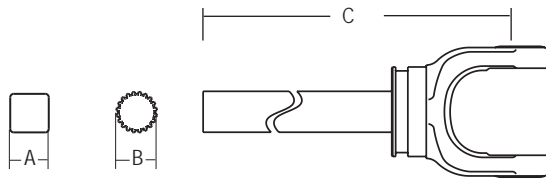

Stock Number	Dim. "A"	Dim. "B"	Dim. "C"
10004448	1 5/16" Sq.		33.12"
10004460	1 5/16" Sq.		45.12"
10014448		1 11/16" × 20 Spl.	33.12"

## Yoke, Tube & Sleeve Assembly

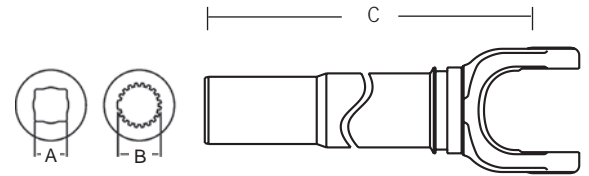

Stock Number	Dim. "A" Bore	Dim. "B" Bore	Dim. "C"
11004448	1 5/16" Sq.		33.63"
11004460	1 5/16" Sq.		45.62"
11014448		1 11/16" × 20 Spl.	33.63"

**Drivelines**

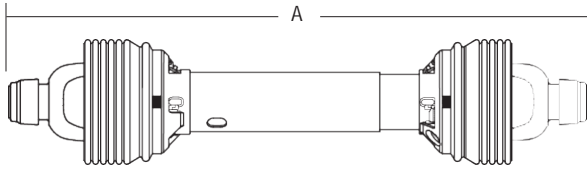

Drivelines are furnished without Cross & Bearing Kit and Implement Yoke. Select kit and yoke as required. When cross & bearing kit and yoke are assembled, the overall compressed length of the driveline will be 48" or 60".

Stock Number	Shaft Size	Tractor Yoke	Overall Compressed Length Dim. "A"	Max. Length
14004448	1 5/16"	1 3/8" × 6 Spl. Q.D.	48"	72"
14004460	1 5/16"	1 3/8" × 6 Spl. Q.D.	60"	96"
14044448	1 11/16" × 20 Spl.	1 3/8" × 6 Spl. Q.D.	48"	72"

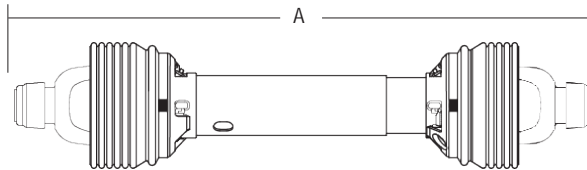

Drivelines are furnished without Cross & Bearing Kit and Outboard Yokes. Select kit and outboard yokes as required. When cross & bearing kit and outboard yokes are assembled, the overall compressed length of the driveline will be 48" or 60".

Stock Number	Shaft	Overall Compressed Length Dim. "A"	Max. Length
14014448	1 5/16"	48"	72"
14014460	1 5/16"	60"	96"
14054448	1 11/16" × 20 Spl.	48"	72"

# 55 Series

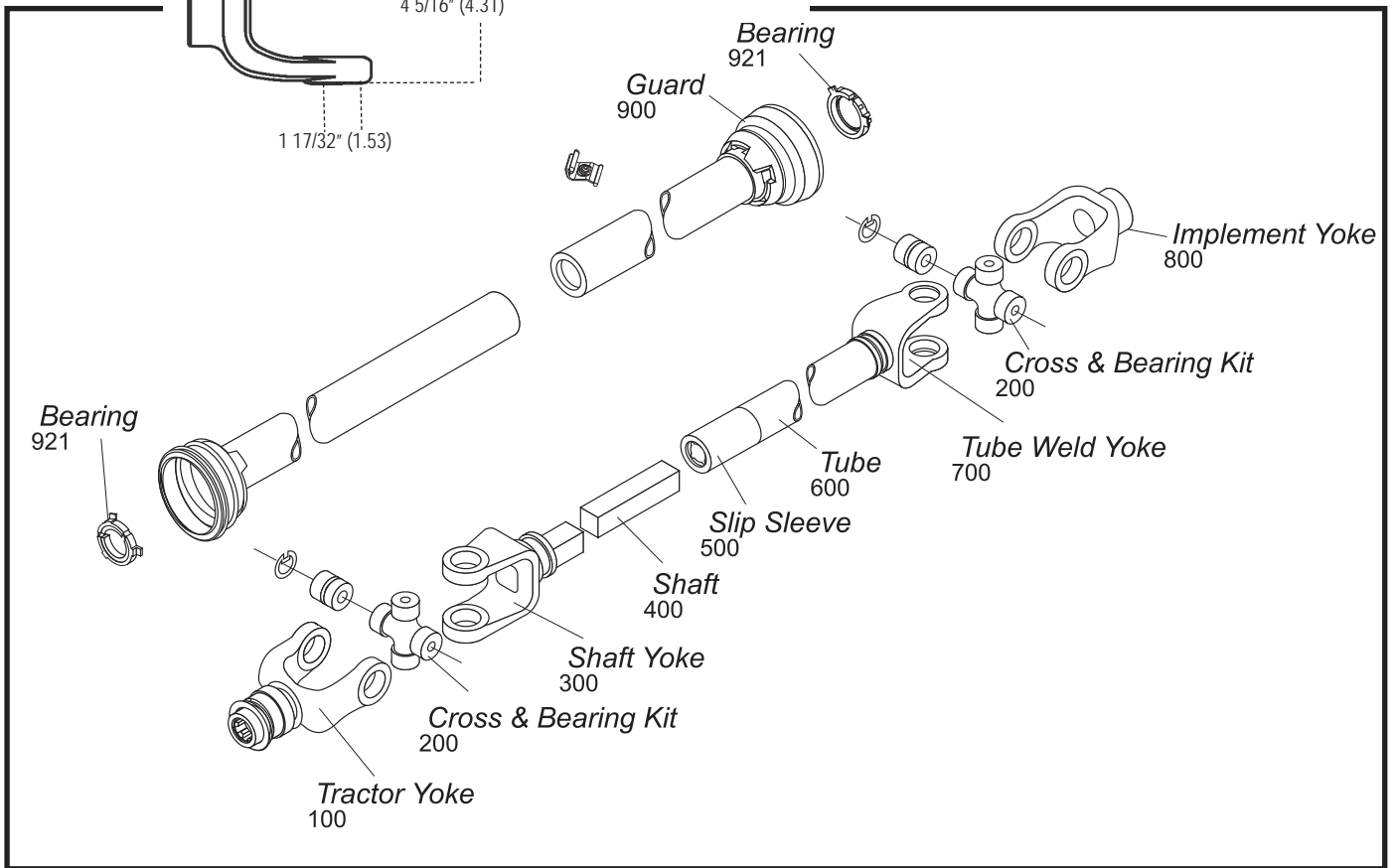

## Tractor Yoke

### Safety Slide Lock

Repair Kit —  
\*13004000  
\*\*13004020

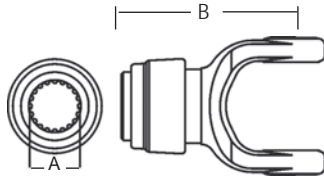

Stock Number	Dim. "A" Bore	Dim. "B"
101-5506*	1 3/8" × 6 Spl.	5 13/16"
101-5520**	1 3/4" × 20 Spl.	6"
101-5521*	1 3/8" × 21 Spl.	5 13/16"

### Ball Shear Device

With Safety Slide Lock

Repair Kit —  
\*13004000  
\*\*13004020

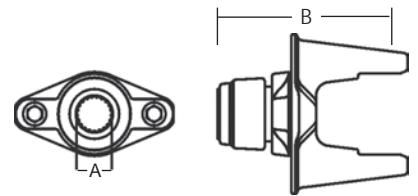

Stock Number	Dim. "A" Bore	Dim. "B"	Shear Bolt
104-5506*	1 3/8" × 6 Spl.	6 1/8"	(2) 3/8" x 16 Gr. 5
104-5520**	1 3/4" × 20 Spl.	6 5/8"	(2) 3/8" x 16 Gr. 5
104-5521*	1 3/8" × 21 Spl.	6 1/8"	(2) 3/8" x 16 Gr. 5

Replacement Shear Bolt Part # 11-10445

### Ball Shear Device Clamp-Style

Stock Number	Dim. "A" Bore	Dim. "B"
114-5520	1 3/4" × 20 Spl.	5 13/16"

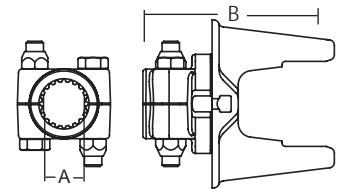

### Quick Disconnect

Repair Kit —  
\*13002006  
\*\*13002021  
\*\*\*13002020  
\*\*\*\*13002806

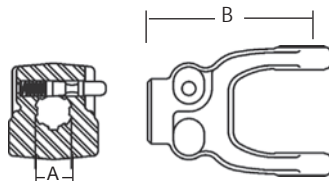

Stock Number	Dim. "A" Bore	Dim. "B"
102-5506*	1 3/8" × 6 Spl.	5 5/8"
102-5521**	1 3/8" × 21 Spl.	5 1/8"
102-5520***	1 3/4" × 20 Spl.	6 1/8"
102-5528****	1 3/4" × 6 Spl.	5 5/8"

### Auto-Lok

Repair Kit  
\*13004000  
\*\*13004020

Stock Number	Dim. "A" Bore	Dim. "B"
110-5506*	1 3/8" × 6 Spl.	5 13/16"
110-5520**	1 3/4" × 20 Spl.	6"
110-5521*	1 3/8" × 21 Spl.	5 13/16"

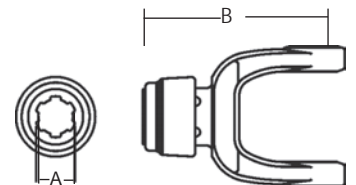

## Cross & Bearing Kit

(R-Kit)

(Recommended 8 hour grease interval)

Snap Ring Located in Yoke

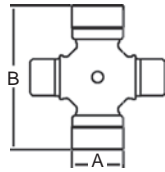

Stock Number	Dim. "A"	Dim. "B"
200-5500	1 17/32"	4 5/16"

## Spline Shaft

Induction Hardened



Stock Number	Dim. "A"	Length	Major Dim.
404-2720	1 11/16" x 20 Spl.	3'	1.790/1.785

## Extended Lubrication Cross & Bearing Kit

(E-Kit)

(Recommended 50 hour grease interval)

Snap Ring Located in Yoke

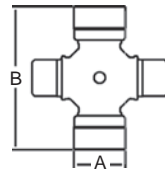

Stock Number	Dim. "A"	Dim. "B"
201-5500	1 17/32"	4 5/16"

## Slip Sleeve



With Grease Groove

Stock Number	Dim. "A" Bore	Dim. "B" Bore	Length	Fits Tube Size.
500-4400		1 5/16" Sq.	5"	2 1/2" (.120 Wall)
505-3500	1 11/16" x 20 Spl.		5"	2 1/2" (.120 Wall)

## Shaft Weld Yoke

With Bearing Groove  
(Guard must rotate freely on yoke)

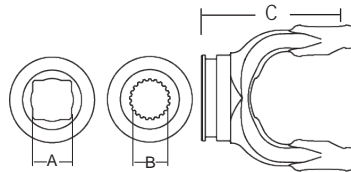

Stock Number	Dim. "A" Bore	Dim. "B" Bore	Dim. "C"
300-5500	1 5/16" Sq.		4 1/8"
301-5500*	1 3/16" Sq.		4 3/8"
302-5500		1 11/16" x 20 Spl.	3 3/4"

\*Use 04-15155 Nylon Bearing

With Grease Reservoir



Stock Number	Dim. "A" Bore	Dim. "B" Bore	Length	Fits Tube Size.
503-3500	1 11/16" x 20 Spl.		8"	2 1/2" (.120 Wall)
504-3500		1 5/16" Sq.	8"	2 1/2" (.120 Wall)

## Shaft

1 5/16" Square



Stock Number	Length
400-0021	6'
404-0021	3'

## Tube

2 1/2" (.120 Wall)

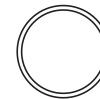

Stock Number	Length
602-4400	6'
604-4400	3'

# 55 Series (cont'd.)

## Tube Weld Yoke

With Bearing Groove  
(Guard must rotate freely on yoke)

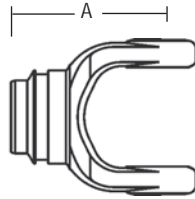

Stock Number	Dim. "A"	Fits Tube Size
701-5500	4 5/8"	2 1/2" (.120 wall)
*704-5500 (with bore)	4 5/8"	2 1/2" (.120 wall)

\* Bore through for Telescoping

## Square Bore With Set Screw

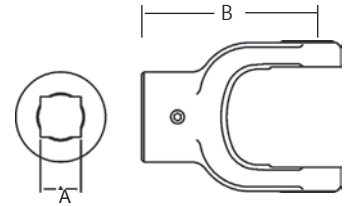

Stock Number	Dim. "A" Bore	Dim. "B"
804-5520	1 1/4"	4 5/8"

## Implement Yoke

Round Bore  
With Keyway & Set Screw

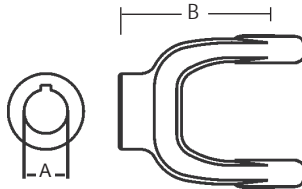

Stock Number	Dim. "A" Bore	Dim. "B"	Standard Keyway
800-5522	1 3/8"	4 1/2"	5/16"
800-5524	1 1/2"	4 5/8"	3/8"
800-5526	1 5/8"	4 5/8"	3/8"
800-5528	1 3/4"	4 5/8"	3/8"
800-5532	2"	4 5/8"	1/2"

## Clamp Yoke

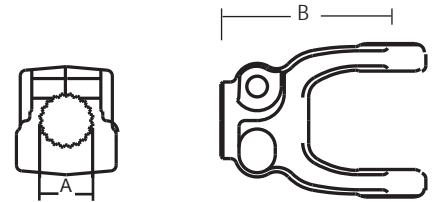

Stock Number	Dim. "A" Bore	Dim. "B"
807-5506	1 3/8" x 6 Spl.	5 5/8"
807-5520	1 3/4" x 20 Spl.	5 1/4"
807-5521	1 3/8" x 21 Spl.	5 1/4"
807-5527	1 3/4" x 27 Spl.	5 5/8"
807-5528	1 3/4" x 6 Spl.	5 5/8"

Spline Bore  
With 21/64" Pin Hole

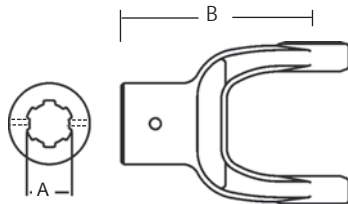

Stock Number	Dim. "A" Bore	Dim. "B"
801-5506	1 3/8" x 6 Spl.	4 1/2"
801-5521	1 3/8" x 21 Spl.	4 1/2"

Stock Bore  
With Hub O. D. Turned

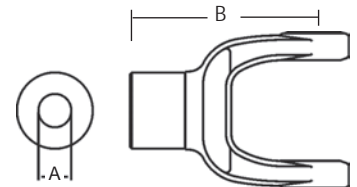

Stock Number	Dim. "A" Bore	Dim. "B"
809-5516	1"	5 5/8"

## Guard

Order Bearings as Required

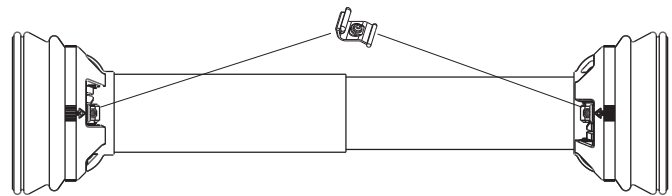

Stock Number	Overall Driveline Length	Bearing Kit (2-per kit)
902-3548	48"	921-4400
902-3560	60"	921-4400

Assembly instructions included with guard bearing kit  
NOTE: Guards must rotate freely on yokes

## Guard Chain Kit

Insert the "S" hook through the guard loop and crimp shut



Part Number: 13006500 (2-per Kit)

## Easy Lock™ Replacement Kit

Part Number: 13005000 (4-per Kit)



**Yoke & Shaft Assembly**

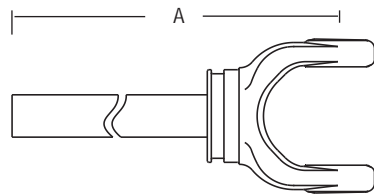

Stock Number	Shaft Size	Dim. "A"
10005548	1 5/16"	32.75"
10005560	1 5/16"	44.88"
10015548	1 11/16" x 20 Spl.	32.75"

**Yoke, Tube & Sleeve Assembly**

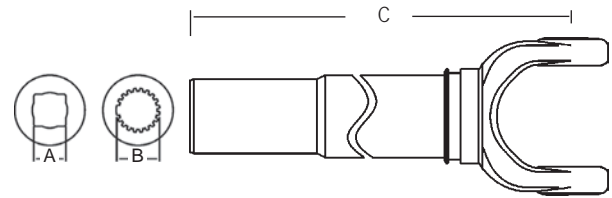

Stock Number	Dim. "A" Bore	Dim. "B" Bore	Dim. "C"
11005548	1 5/16" Sq.		33.38"
11005560	1 5/16" Sq.		45.38"
11015548		1 11/16" x 20 Spl.	33.38"

**Drivelines**

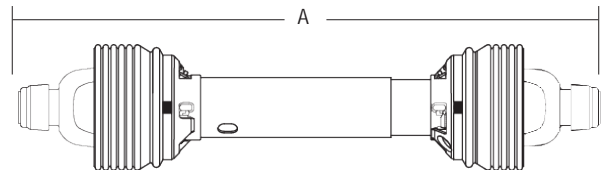
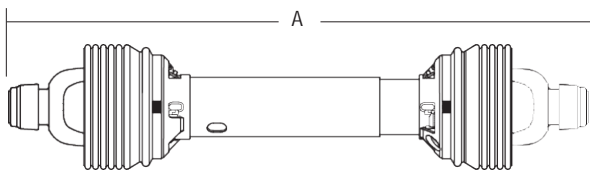

Drivelines are furnished without Cross & Bearing Kit and Implement Yoke. Select kit and yoke as required. When cross & bearing kit and yoke are assembled, the overall compressed length of the driveline will be 48" or 60".

Drivelines are furnished without Cross & Bearing Kit and Outboard Yokes. Select kit and outboard yokes as required. When cross & bearing kit and outboard yokes are assembled, the overall compressed length of the driveline will be 48", 58" or 60".

Stock Number	Shaft Size	Tractor Yoke	Overall Compressed Length Dim. "A"	Max. Length
14005548	1 5/16"	1 3/8" x 6 Spl. Q.D.	48"	72"
14005560	1 5/16"	1 3/8" x 6 Spl. Q.D.	60"	96"
14045548	1 11/16" x 20 Spl.	1 3/8" x 6 Spl. Q.D.	48"	72"

Stock Number	Shaft	Overall Compressed Length Dim. "A"	Max. Length
14015548	1 5/16" Sq.	48"	72"
14015560	1 5/16" Sq.	60"	96"
14055548	1 11/16" x 20 Spl.	48"	72"
14055558	1 11/16" x 20 Spl.	58"	92"

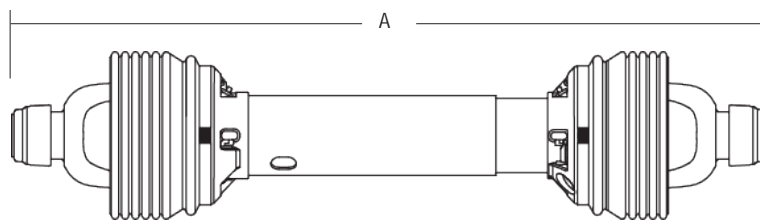

Stock Number	Tractor Yoke	Implement Yoke	Overall Compressed Length Dim. "A"	Max. Length	Application	Shaft Size
14005537	1 3/8" x 6 Spl. Safety Slide Lock	1 3/8" x 6 Spl. Safety Slide Lock	37"	50"	All Purpose	1 5/16" Sq.
14005546	1 3/4" x 20 Spl. Safety Slide lock	1 3/4" Rd. w/ Keyway and (2) Set Screws	46"	68"	All Purpose	1 11/16" x 20 Spl.



# 77 Series

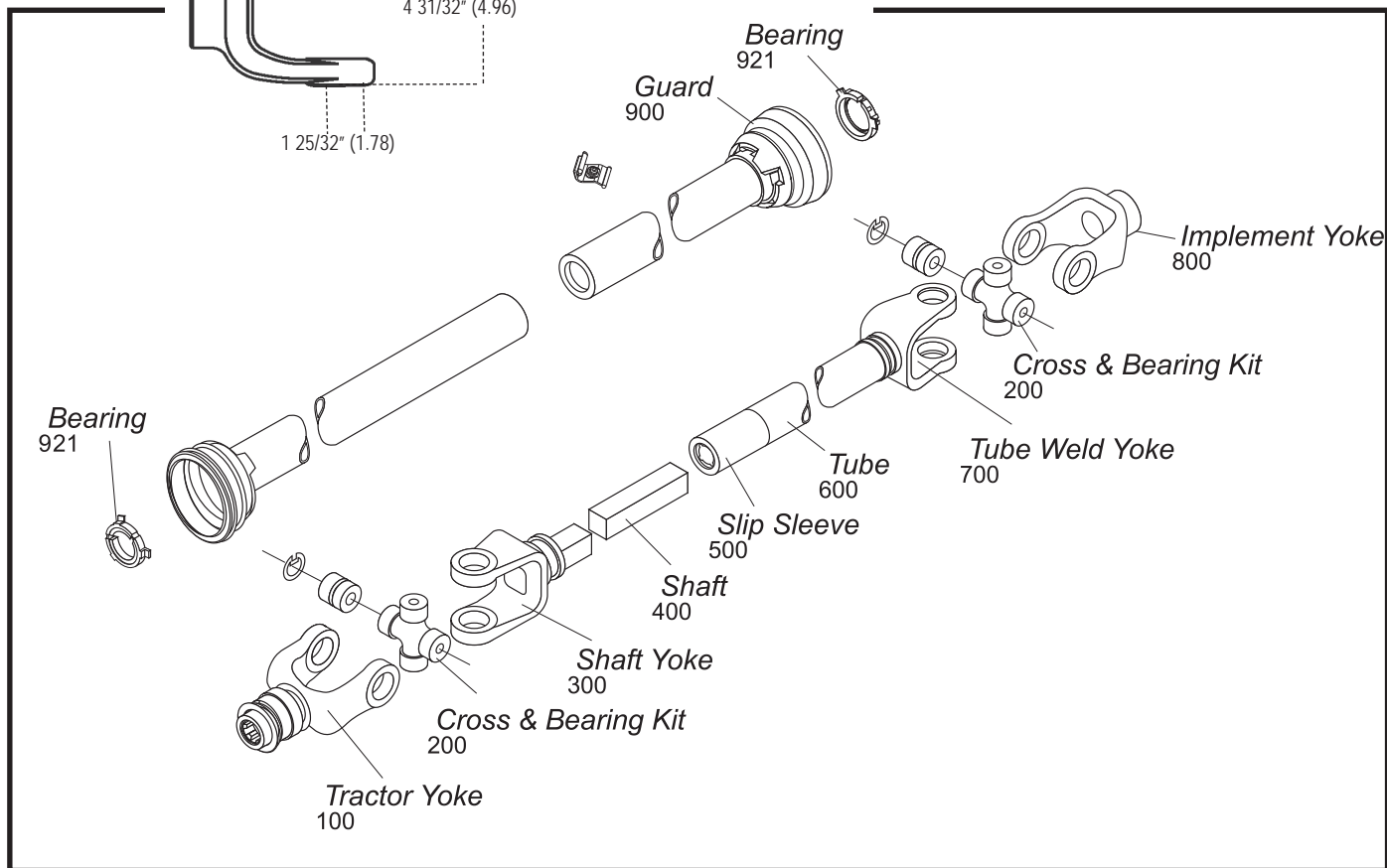

## Tractor Yoke

**Auto-Lok**  
Repair Kit -  
\*19-15198  
\*\*13004020  
\*\*\*26-13387

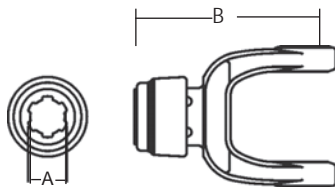

Stock Number	Dim. "A" Bore	Dim. "B"
110-7706*	1 3/8" x 6 Spl.	7"
110-7720**	1 3/4" x 20 Spl.	7"
110-7721*	1 3/8" x 21 Spl.	7"
110-7728***	1 3/4 x 6 Spl.	7"

## Extended Lubrication Cross & Bearing Kit (E-Kit)

(Recommended 50 hr. grease interval)

Snap Ring Located in Yoke

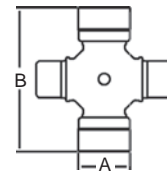

Stock Number	Dim. "A"	Dim. "B"
201-7700	1 25/32"	4 31/32"

## Spline Shaft

**Spline Shaft**  
Induction Hardened



Stock Number	Dim. "A"	Length	Major Dim.
404-7720	2" x 20 Spl.	3'	1.978/1.973

## Slip Sleeve

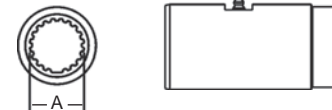

With Grease Groove

Stock Number	Dim. "A" Bore	Length	Fits Tube Size
505-7700	2" x 20 Spl.	5"	3" (.188 wall)

### Shaft Weld Yoke

With Bearing Groove  
(Guard must rotate freely on yoke)

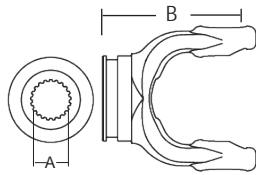

Stock Number	Dim. "A" Bore	Dim. "B" Bore
302-7700	2" x 20 Spl.	5 1/4"

### Implement Yoke

Round Bore  
With Keyway & Set Screw

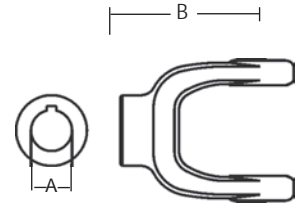

Stock Number	Dim. "A" Bore	Dim. "B"	Standard Keyway
800-7728	1 3/4"	5 3/4"	3/8"
800-7732	2"	6 1/4"	1/2"

### Tube

3" (.188 Wall)



Stock Number	Length
602-7700	6'
604-7700	3'

### Clamp Yoke

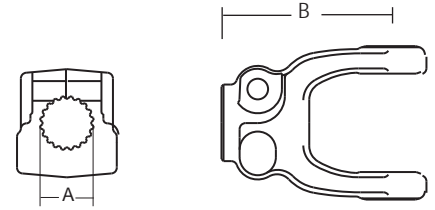

Stock Number	Dim. "A" Bore	Dim. "B"
807-7720	1 3/4" x 20 Spl.	6 1/4"
807-7732	2" Rd.	6 1/4"

### Tube Weld Yoke

With Bearing Groove  
(Guard must rotate freely on yoke)

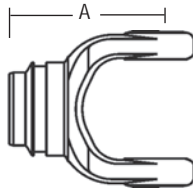

Stock Number	Dim. "A"	Fits Tube Size
*704-7700 (with bore)	5 3/4"	3" (.188 wall)

\*Bore through for Telescoping

### Yoke & Shaft Assembly

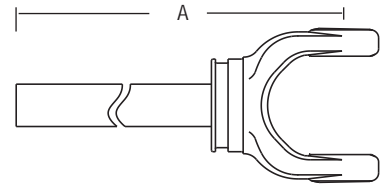

Stock Number	Shaft Size	Dim. "A"
10017748	2" x 20 Spl.	32.75"

### Guard

\* Order Bearings as Required

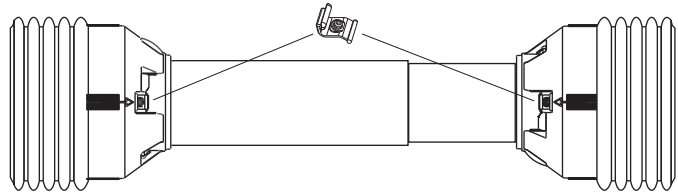

Stock Number	Overall Driveline Length	Bearing Kit (2-per kit)
900-4548	48"	961-4535
900-4560	60"	961-4535

Assembly instructions included with guard bearing kit  
NOTE: Guards must rotate freely on yokes

### Guard Chain Kit

Part Number: 13006500 (2-per Kit)

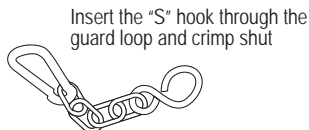

Insert the "S" hook through the guard loop and crimp shut

### Easy Lock™ Replacement Kit

Part Number: 13005000 (4-per Kit)



# W Series

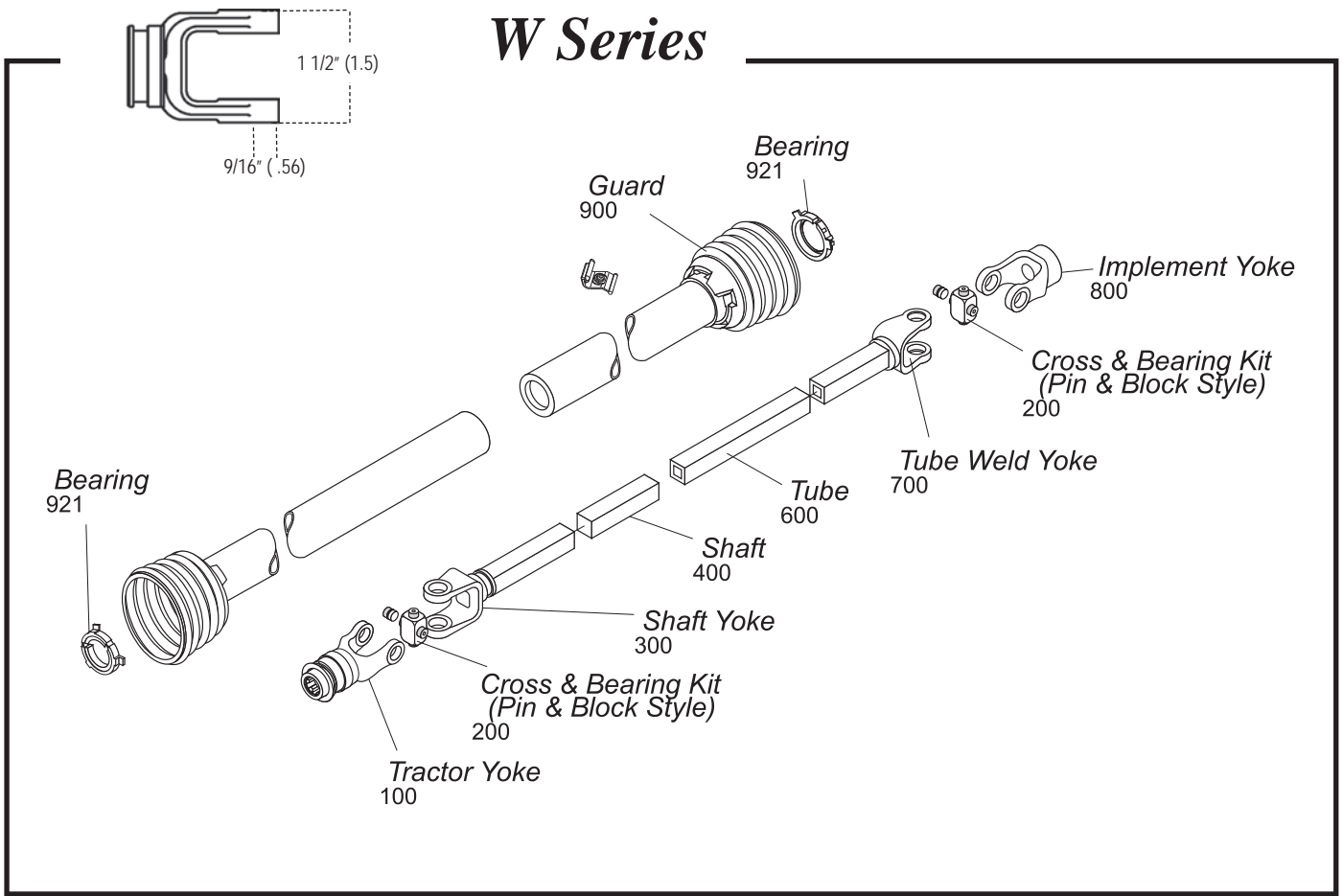

## Cross & Bearing Kit (Pin & Block Style)

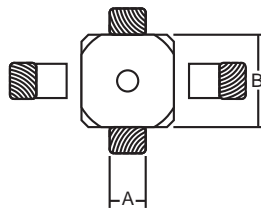

Zerk Located in Block

Stock Number	Dim. "A"	Dim. "B"
200-0700	9/16"	1 1/2"

## Tube

1 1/4" Square O.D.

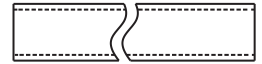

Stock Number	Length	Fits Shaft
600-0015	6'	15/16" Sq.

## Shaft

15/16" Square

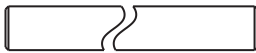

Stock Number	Length	Fits Shaft
400-0015	6'	1 1/4" Sq.

**Guard**

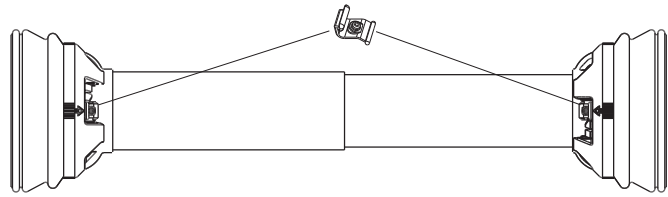

Stock Number	Overall Driveline Length	Bearing Kit (2-per kit)
900-2548	48"	921-5170

Assembly instructions included with guard bearing kit  
 NOTE: Guards must rotate freely on yokes

**Guard Chain Kit**

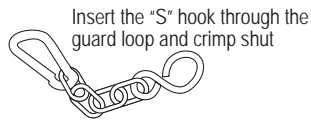

Part Number: 13006500 (2-per Kit)

**Easy Lock™ Replacement Kit**

Part Number: 13005000 (4-per Kit)



**Drivelines**

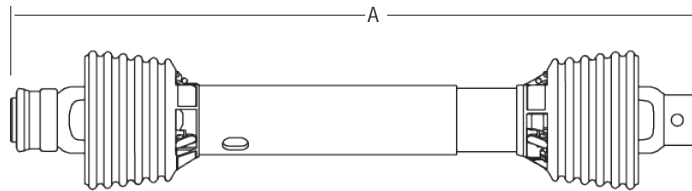

Use 12 Series driveline for all "W" Series replacement drivelines. See 12 Series (Page 54) for drivelines.

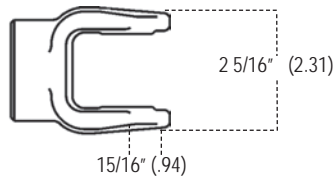

# 0675 Series

Interchanges with Neapco

## Tractor Yoke

**Spring-Lok**  
Repair Kit - 13003100

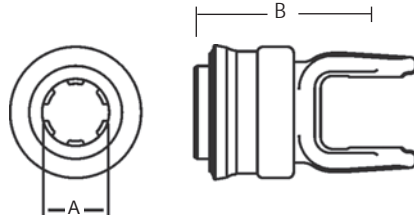

Stock Number	Dim. "A" Bore	Dim. "B"
100-0506	1 3/8" × 6 Spl.	3 7/8"

**Quick Disconnect**  
Repair Kit - 13002006

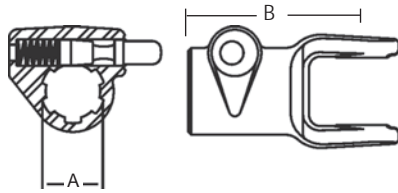

Stock Number	Dim. "A" Bore	Dim. "B"
102-0506	1 3/8" × 6 Spl.	3 7/8"

## Cross & Bearing Kit

**(R Kit)**  
(Recommended 8 hr. grease interval)

Snap Ring Located in Bushing

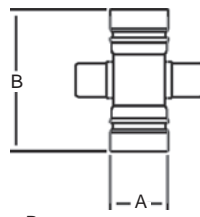

Stock Number	Dim. "A"	Dim. "B"
200-0675	15/16"	2 5/16"

## Shaft Weld Yoke

With Bearing Groove  
(Guard must rotate freely on yoke)

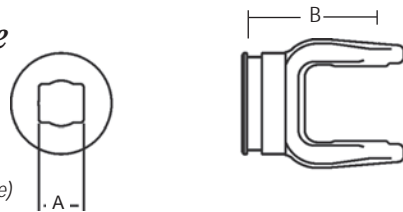

Stock Number	Dim. "A" Bore	Dim. "B"
300-0500	3/4" × 7/8"	2 1/2"

## Tube Weld Yoke

With Bearing Groove  
(Guard must rotate freely on yoke)

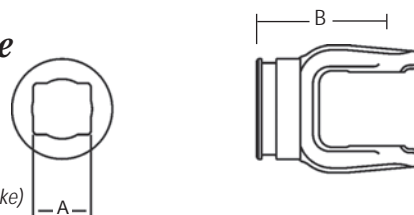

Stock Number	Dim. "A" Bore	Dim. "B"
700-0500	1" × 1 1/8"	2 1/2"

## Implement Yoke

**Round Bore**  
With Keyway & Set Screw

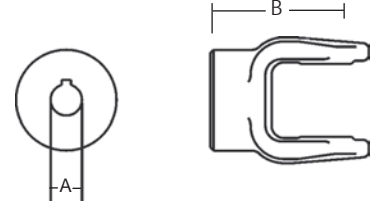

Stock Number	Dim. "A" Bore	Dim. "B"	Standard Keyway
800-0512	3/4"	2 1/2"	3/16"

**Spline Bore**  
With 21/64" Pin Hole

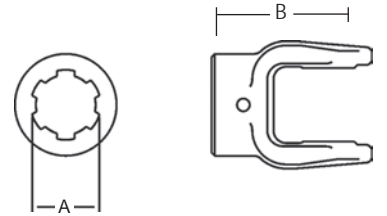

Stock Number	Dim. "A" Bore	Dim. "B"
801-0506	1 3/8" × 6 Spl.	2 1/2"

**Square Bore**  
With Set Screw

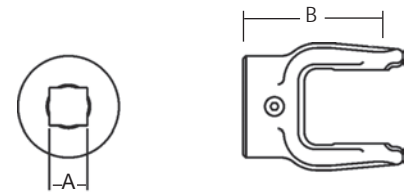

Stock Number	Dim. "A" Bore	Dim. "B"
804-0512	3/4"	2 1/2"
804-0514	7/8"	2 1/2"
804-0516	1"	2 1/2"

**Round Bore**  
With Double Keyway & Set Screw

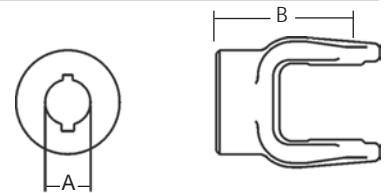

Stock Number	Dim. "A" Bore	Dim. "B"	Double Keyway
806-0514	7/8"	2 1/2"	3/16" & 1/4"
806-0516	1"	2 1/2"	3/16" & 1/4"
806-0518	1 1/8"	2 1/2"	1/4" & 5/16"
806-0520	1 1/4"	2 1/2"	1/4" & 5/16"

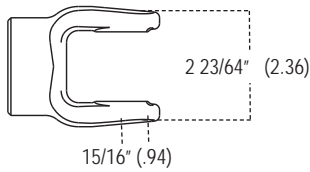

# 1000 Series

*Interchanges with Spicer and Neapco*

## Tractor Yoke

**Quick Disconnect**  
Repair Kit - 13002006

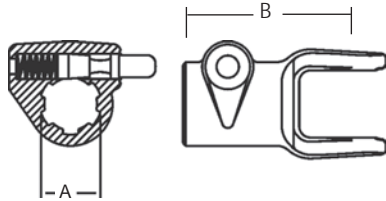

Stock Number	Dim. "A" Bore	Dim. "B"
102-1006	1 3/8" x 6 Spl.	3 7/8"

## Cross & Bearing Kit (R Kit)

(Recommended 8 hr. grease interval)

Snap Ring Located in Bushing

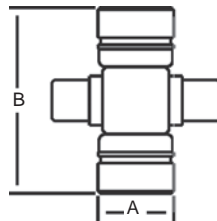

Stock Number	Dim. "A"	Dim. "B"
200-1000	15/16"	2 23/64"

## Shaft Weld Yoke

with Bearing Groove  
(Guard must rotate freely on yoke)

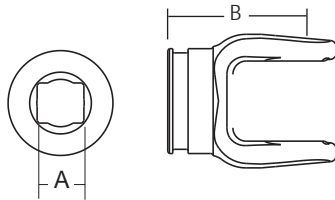

Stock Number	Dim. "A" Bore	Dim. "B"
300-1000	3/4" x 7/8" Rect.	2 1/2"

## Tube Weld Yoke

with Bearing Groove  
(Guard must rotate freely on yoke)

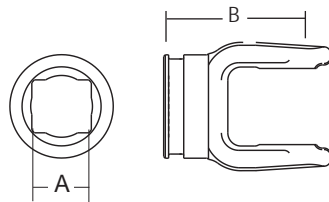

Stock Number	Dim. "A" Bore	Dim. "B"
700-1000	1" x 1 1/8"	2 1/2"

## Implement Yoke

**Round Bore**  
Keyway & Set Screw

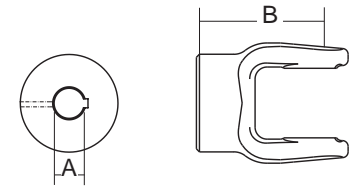

Stock Number	Dim. "A" Bore	Keyway	Dim. "B"
800-1010	5/8"	3/16" (.19)	2 1/2" (2.50)
10001-1044	5/8"	3/16" (.19)	1 11/16" (1.69)
10001-1045	3/4"	3/16" (.19)	2 1/2" (2.50)
10001-1038	3/4"	3/16" (.19)	1 11/16" (1.69)
10001-1056	3/4"	1/4" (.25)	2 1/2" (2.50)
800-1013	13/16"	1/4" (.25)	2 1/2" (2.50)
10001-1057	7/8"	3/16" (.19)	2 1/2" (2.50)
10001-1049	7/8"	1/4" (.25)	2 1/2" (2.50)
10001-1048	7/8"	1/4" (.25)	2 1/2" (2.50)
800-1015	15/16"	1/4" (.25)	2 1/2" (2.50)
800-1016	1"	3/16" (.19)	2 1/2" (2.50)
10001-1051	1"	1/4" (.25)	2 1/2" (2.50)
10001-1033	1"	1/4" (.25)	2 1/2" (2.50)
10001-1041	1"	1/4" (.25)	1 11/16" (1.69)
800-1017	1 1/16"	1/4" (.25)	2 1/2" (2.50)
10001-1053	1 1/8"	1/4" (.25)	2 1/2" (2.50)
10001-1052	1 1/8"	5/16" (.31)	2 1/2" (2.50)
800-1019	1 3/16"	5/16" (.31)	2 1/2" (2.50)
10001-1058	1 1/4"	1/4" (.25)	2 1/2" (2.50)
10001-1055	1 1/4"	5/16" (.31)	2 1/2" (2.50)
10001-1054	1 1/4"	5/16" (.31)	2 1/2" (2.50)
10001-1060	1 3/8"	5/16" (.31)	2 1/2" (2.50)
800-1022	1 3/8"	3/8"	2 1/2" (2.50)

**Spline Bore**  
with Set Screw

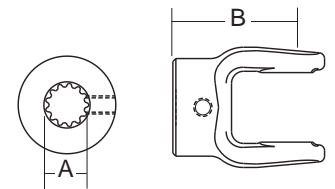

Stock Number	Dim. "A" Bore	Dim. "B"
801-1013	.901" x 13 Spl.	2 1/2" (2.50)
801-1018	1 1/8" x 6 Spl.	2 1/2" (2.50)

Shear Pin

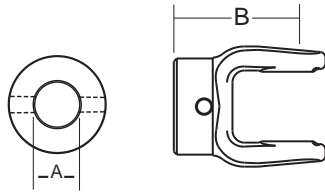

Stock Number	Dim. "A" Bore	Dim. "B"	Pinhole Size
802-1015	15/16"	2 1/2" (2.50)	11/32" (.34) #6 Taper
802-1016	1"	2 1/2" (2.50)	1/4" (.25)
10001-1059	1"	2 1/2" (2.50)	3/8" (.38)
802-1020	1 1/4"	2 1/2" (2.50)	5/16" (.31)
802-1024	1 1/2"	2 1/2" (2.50)	9/32" (.28)
10001-1034	1 1/2"	2 1/2" (2.50)	17/64" (.27)

Round Bore

Double Keyway & Set Screw

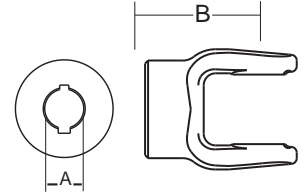

Stock Number	Dim. "A" Bore	Double Keyway	Dim. "B"
806-1012	3/4"	3/16" & 1/4"	2 1/2" (2.50)
806-1013	13/16"	3/16" & 1/4"	2 1/2" (2.50)
806-1014	7/8"	3/16" & 1/4"	2 1/2" (2.50)
806-1016	1"	3/16" & 1/4"	2 1/2" (2.50)
806-1018	1 1/8"	3/16" & 1/4"	2 1/2" (2.50)
10001-1061	1 1/8"	1/4" & 5/16"	2 1/2" (2.50)
806-1020	1 1/4"	1/4" & 5/16"	2 1/2" (2.50)
806-1019	1 3/16"	1/4" & 5/16"	2 1/2" (2.50)

Square Bore  
with Set Screw

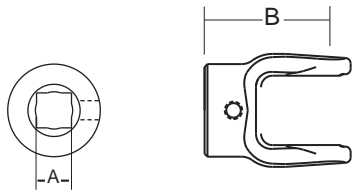

Stock Number	Dim. "A" Bore	Dim. "B"
804-1012	3/4"	2 1/2" (2.50)
10001-1042	3/4"	1 11/16" (1.69)
804-1014	7/8"	2 1/2" (2.50)
10001-1043	7/8"	1 11/16" (1.69)
804-1016	1"	2 1/2" (2.50)
804-1018	1 1/8"	2 1/2" (2.50)
10001-1037	1 1/8"	2 1/2" (2.50)

Hexagon Bore  
with Set Screw

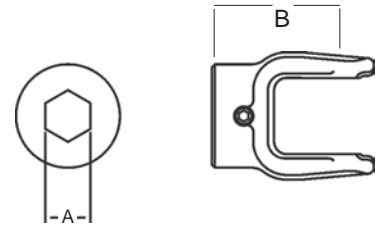

Stock Number	Dim. "A" Bore	Dim. "B"
805-1014	7/8"	2 1/2"
805-1018	1 1/8"	2 1/2"

Square Bore  
with Pinhole

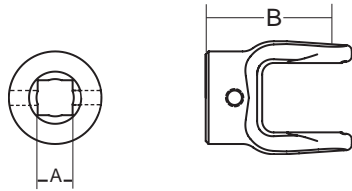

Stock Number	Dim. "A" Bore	Dim. "B"	Pinhole Size
10001-1035	3/4"	2 1/2" (2.50)	5/16" (.312)

Slip Sleeve Yoke

Square

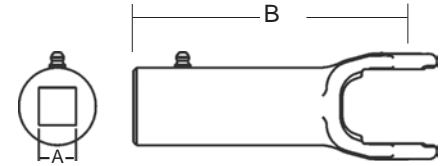

Stock Number	Dim. "A" Bore	Dim. "B"
808-1012	3/4"	5 1/2"
808-1014	7/8"	5 1/2"
808-1016	1"	5 1/2"

Slip Sleeve Yoke cont...

Round

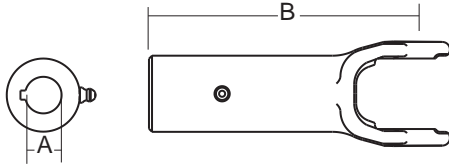

Stock Number	Dim. "A" Bore	Keyway	Dim. "B"
810-1012	3/4"	3/16"	5 1/2" (5.50)
810-1013	13/16"	1/4"	5 1/2" (5.50)
810-1014	7/8"	1/4"	5 1/2" (5.50)
810-1016	1"	1/4"	5 1/2" (5.50)
810-1018	1 1/8"	1/4"	5 1/2" (5.50)
10001-1062	1 1/8"	5/16"	5 1/2" (5.50)
810-1020	1 1/4"	1/4"	5 1/2" (5.50)
10001-1013	1 1/4"	5/16"	5 1/2" (5.50)
10001-1066	1 1/8"	1/4"	5 1/2" (5.50)

Spline

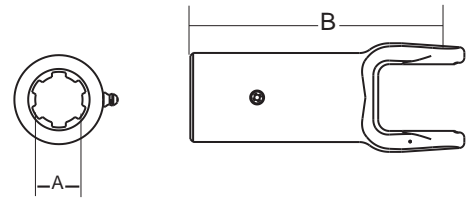

Stock Number	Dim. "A" Bore	Dim. "B"
812-1018	1 1/8" x 10 Spl.	5 1/2" (5.50)
812-1020	1 1/4" x 6 Spl.	5 1/2" (5.50)

Hex

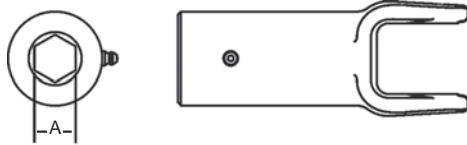

Stock Number	Dim. "A" Bore
811-1014	7/8"
811-1018	1 1/8"

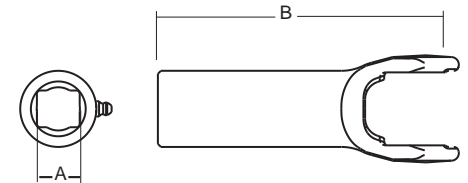

Stock Number	Dim. "A" Bore	Dim. "B"
813-1012	3/4" x 7/8"	5-1/2" (5.50)
10001-1015	1"	5-1/2" (5.50)

Guard

Order Bearings As Required

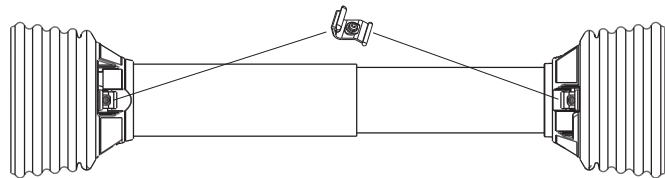

Stock Number	Overall Driveline Length	Bearing Kit (4-per kit)
900-2548	48"	921-0600
900-2560	60"	921-0600

Assembly instructions included with guard bearing kit  
NOTE: Guards must rotate freely on yokes

Guard Chain Kit

Part Number: 13006500 (2-per Kit)

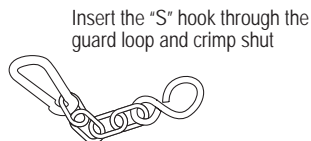

Insert the "S" hook through the guard loop and crimp shut

Easy Lock™ Replacement Kit

Part Number: 13005000 (4-per Kit)





## 1800 Series

Interchanges with Neapco

### Cross & Bearing Kit

(R Kit)

(Recommended 8 hr. grease interval)

Snap Ring Located in Yoke



Stock Number	Dim. "A"	Dim. "B"
200-1875	1"	3 7/32"

## 14 Series

### Cross & Bearing Kit

(R Kit)

(Recommended 8 hr. grease interval)

Interchanges with Howse  
Snap Ring Located in Bushing

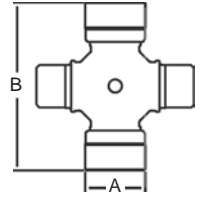

Stock Number	Dim. "A"	Dim. "B"
200-1401	1 1/8"	3 5/32"

## 1 FR Series

### Cross & Bearing Kit

(R Kit)

(Recommended 8 hr. grease interval)

Snap Ring Located in Yoke

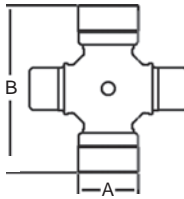

Stock Number	Dim. "A"	Dim. "B"
200-0100	7/8"	2 15/16"

## 35 Series

### Cross & Bearing Kit

(R Kit)

(Recommended 8 hr. grease interval)

Interchanges with Howse  
Snap Ring Located in Bushing

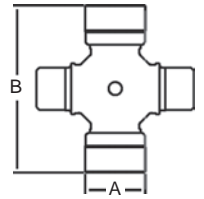

Stock Number	Dim. "A"	Dim. "B"
200-3501	1 1/4"	3 7/32"

## Vehicular Cross & Bearing Kit

Interchanges with Spicer

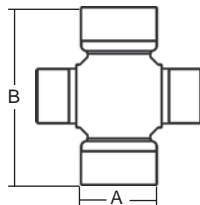

Stock Number	Spicer U - Joint Series	Dim. "A"	Dim. "B"
200-0310	1310	1 1/16"	3 7/32"
200-0350	1350	1 3/16"	3 5/8"
200-0410	1410	1 3/16"	4 3/16"

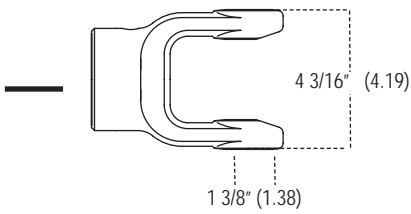

# 2600 Series

Interchanges with Neapco & Walterscheid 1480

## Tractor Yoke

Repair Kit -  
\* 13002006  
\*\* 13002020  
\*\*\* 13002021

Quick Disconnect

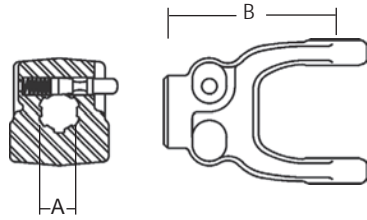

Stock Number	Dim. "A" Bore	Dim. "B"
102-2606*	1 3/8" x 6 Spl.	5 5/16"
102-2620**	1 3/4" x 20 Spl.	5 5/16"
102-2621***	1 3/8" x 21 Spl.	5 5/16"

## Shaft



1 5/16" Square

Stock Number	Length
400-0021	6'
401-0021	10'
404-0021	3'

## Cross & Bearing Kit

(R Kit)  
(Recommended 8 hr. grease interval)

Snap Ring Located in Yoke

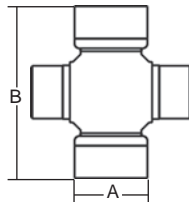

Stock Number	Dim. "A"	Dim. "B"
200-2600	1 3/8"	4 3/16"

## Slip Sleeve



1 5/16" Square  
With Grease Groove

Stock Number	Length	Fits Tube Size
500-2600	5"	2 3/4" (.109 Wall)

## Shaft Weld Yoke

With Bearing Groove  
(Guards must rotate freely on the yoke)



Stock Number	Dim. "A" Bore	Dim. "B"
300-2600	1 5/16" Sq.	4 1/8"

## Tube

2 3/4" (.109 Wall)



Stock Number	Length
602-2600	6'

## Tube Weld Yoke

With Bearing Groove  
(Guards must rotate freely on the yoke)

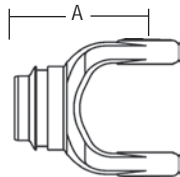

Stock Number	Dim. "A"	Fits Tube Bore
701-2600	4 5/8"	2 3/4" (.109 Wall)

## Implement Yoke

Round Bore  
With Keyway & Set Screw

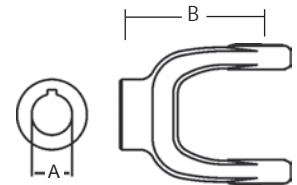

Stock Number	Dim. "A" Bore	Standard Keyway	Dim. "B"
800-2622	1 3/8"	5/16"	4 5/8"
800-2624	1 1/2"	3/8"	4 5/8"
800-2628	1 3/4"	3/8"	4 5/8"

# NORTH AMERICAN SHAFTING & TUBING

## North American Shaft

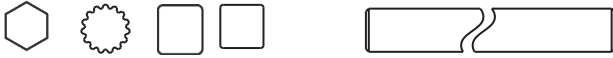

Stock Number	Size	Length
400-0012	3/4" Sq.	6'
400-0014	7/8" Sq.	6'
400-0015	15/16" Sq.	6'
400-0016	1" Sq.	6'
400-0019	1 3/16" Sq.	6'
400-0021	1 5/16" Sq.	6'
400-1214	3/4" x 7/8" Rect.	6'
400-1618	1" x 1 1/8" Rect.	6'
402-0014	7/8" Hex	6'
402-0016	1" Hex	6'
402-0018	1 1/8" Hex	6'
402-0020	1 1/4" Hex	6'
404-0019	1 3/16" Sq.	3'
404-0021	1 5/16" Sq.	3'
404-1214	3/4" x 7/8" Rect.	3'
404-1615H	1" x 15 Spl. (Induction Hardened)	3'
404-1618	1" x 1 1/8" Rect.	3'
404-2120	1 5/16" x 20 Spl. (Induction Hardened)	3'
404-2720	1 11/16" x 20 Spl. (Induction Hardened)	3'
404-7720	1 7/8" X 20 Spl. (Induction Hardened)	3'

## North American Tube



Stock Number	Size	Length
600-0012	1" Sq. Fits Shaft 3/4" Sq.	6'
600-0015	1 1/4" Sq. (.120 Wall) Fits Shaft 15/16"	6'
600-0016	1 1/4" Sq. (.109 Wall) Fits Shaft 1" Sq.	6'
600-1618	1" x 1 x 1/8" Rect.O.D - Fits Shaft 3/4" x 7/8"	6'
600-2022	1 1/4" x 1 3/8" Rect.O.D - Fits Shaft 1" x 1 1/8"	6'
602-0600	1 1/2" Rd. (.065 Wall) O.D.	6'
602-1400	2" Rd. (.083 Wall) O.D.	6'
602-2600	2 3/4" Rd. (.109 Wall) O.D.	6'
602-3500	2 1/8" Rd. (.120 Wall) O.D.	6'
602-4400	2 1/2" Rd. (.120 Wall) O.D.	6'
604-0600	1 1/2" Rd. (.065 Wall) O.D.	3'
604-1400	2" Rd. (.083 Wall) O.D.	3'
604-1618	1" x 1 1/8" Rect.O.D - Fits Shaft 3/4" x 7/8"	3'
604-2022	1 1/4" x 1 3/8" Rect. O.D - Fits Shaft 1" x 1 1/8"	3'
604-3500	2 1/8" Rd. (.120 Wall) O.D.	3'
604-4400	2 1/2" Rd. (.120 Wall) O.D.	3'

## Shock Absorbing Flexible Coupling Disc

6" O.D.

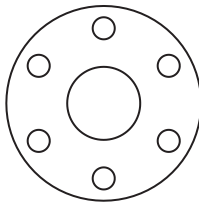

Stock Number	Description
970-2110	Disc only w/ 5/8" Holes
970-2108	Disc only w/ 1/2" Holes

## Spider

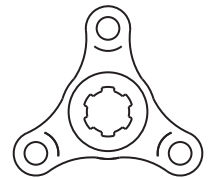

Stock Number	Description
81011-1016	1 3/8" x 6 Spl. with 5/8" Bolt Hole
81013-1053	1 3/8" x 6 Spl. with 21/64" Pinholes & 5/8" Bolt Hole
81021-1097	1 3/4" Rd. with 3/8" Keyway & 5/8" Bolt Hole

## Locking Device

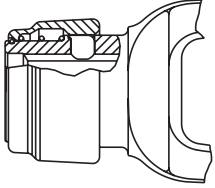

### Safety Slide Lock

An exclusive Weasler replacement component, the Safety Slide Lock\* yoke is locked in place by two hardened pawls with compound radii that conform to the groove in the shaft for full contact. The device is particularly applicable where there is appreciable end thrust.

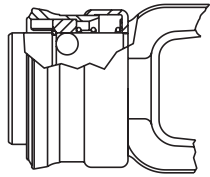

### Spring Lok

The collar is spring loaded for ease of installation and positive locking to tractor shaft

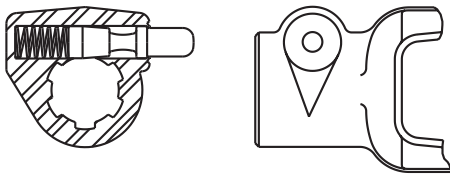

### Quick Disconnect

A smooth plunger eliminates sharp projections such as x-washers. Trails rather than leads rotation.

## Locking Device Repair Kit

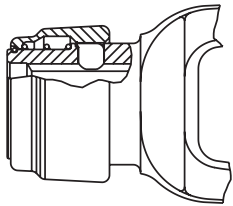

### \*Auto-Lok/Safety Slide Lock

Stock No. 13004000

Repair Kit for Weasler Auto-Lok and Safety Slide Lock  
6 Spline & 21 Spline

Stock No. 13004020

Repair Kit for Weasler Auto-Lok and Safety Slide Lock  
20 Spline

Stock No. 13004015

Repair Kit for 1" x 15 Spl.

This repair kit contains both balls & pawls. When repairing the "Safety Slide Lock" use the pawls only and discard the balls. When repairing the "Auto-Lok" use both the balls and the pawls.

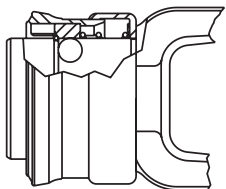

### Spring-Lok

Stock No. 13003100

Repair Kit for Weasler Spring-Lok  
6 Spline & 21 Spline

Stock No. 13003115

1" x 15 Spline

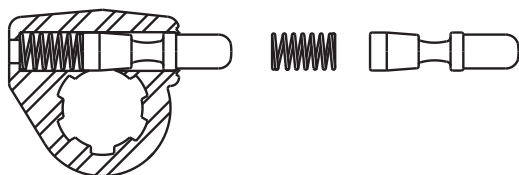

### Quick Disconnect

Stock No. 13002006

Repair Kit for Weasler  
and Rockwell 6 Spline

Stock No. 13002806

Repair Kit for 1 3/4" x 6 Spl.

Stock No. 13002021

Weasler 21 Spline and  
Hex Quick Disconnect

Stock No. 13002020

Weasler 20 Spline





**Weasler**<sup>®</sup>

## Aftermarket Product Guide



# Metric

## Drivelines and Components

# TRANSPARENCY IDENTIFICATION SYSTEM

for Metric Driveline Components  
(Stock No. 12008500)

The individual transparency cards will allow the user to easily identify driveline components. Cross and Bearing Kits may be identified by the bearing cap outside diameter and the width of the cross. Yokes may be identified by the hole in the ear and profile. Profile tubes may be identified by the end sections.

How to use the Transparency Identification System:

1. Match the part to be replaced with the corresponding transparency card for identification.
2. Select the proper stock number for the replacement part.

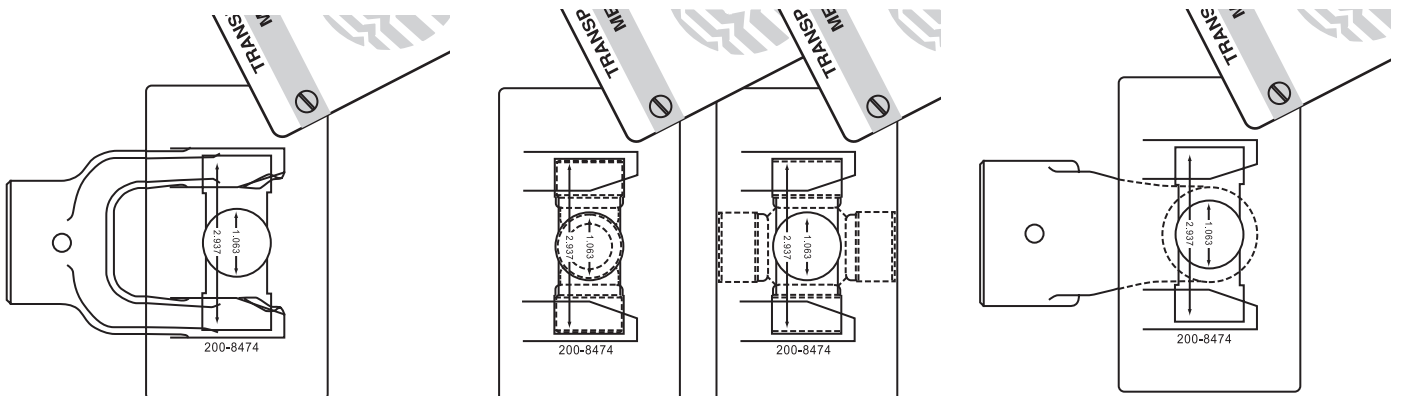
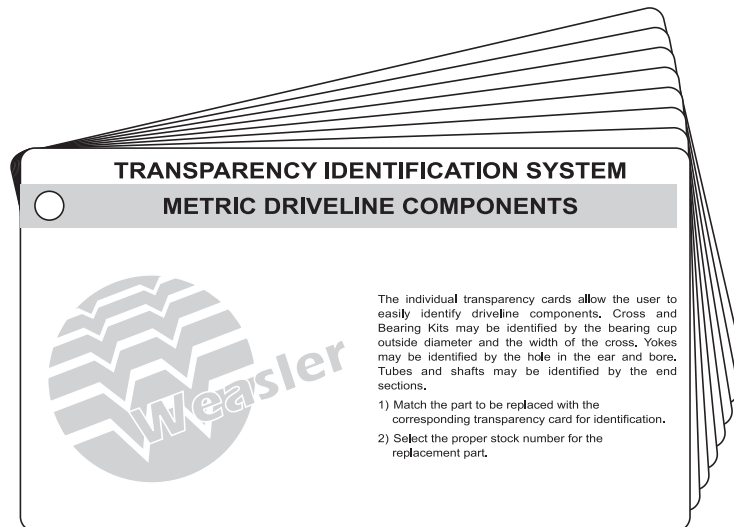

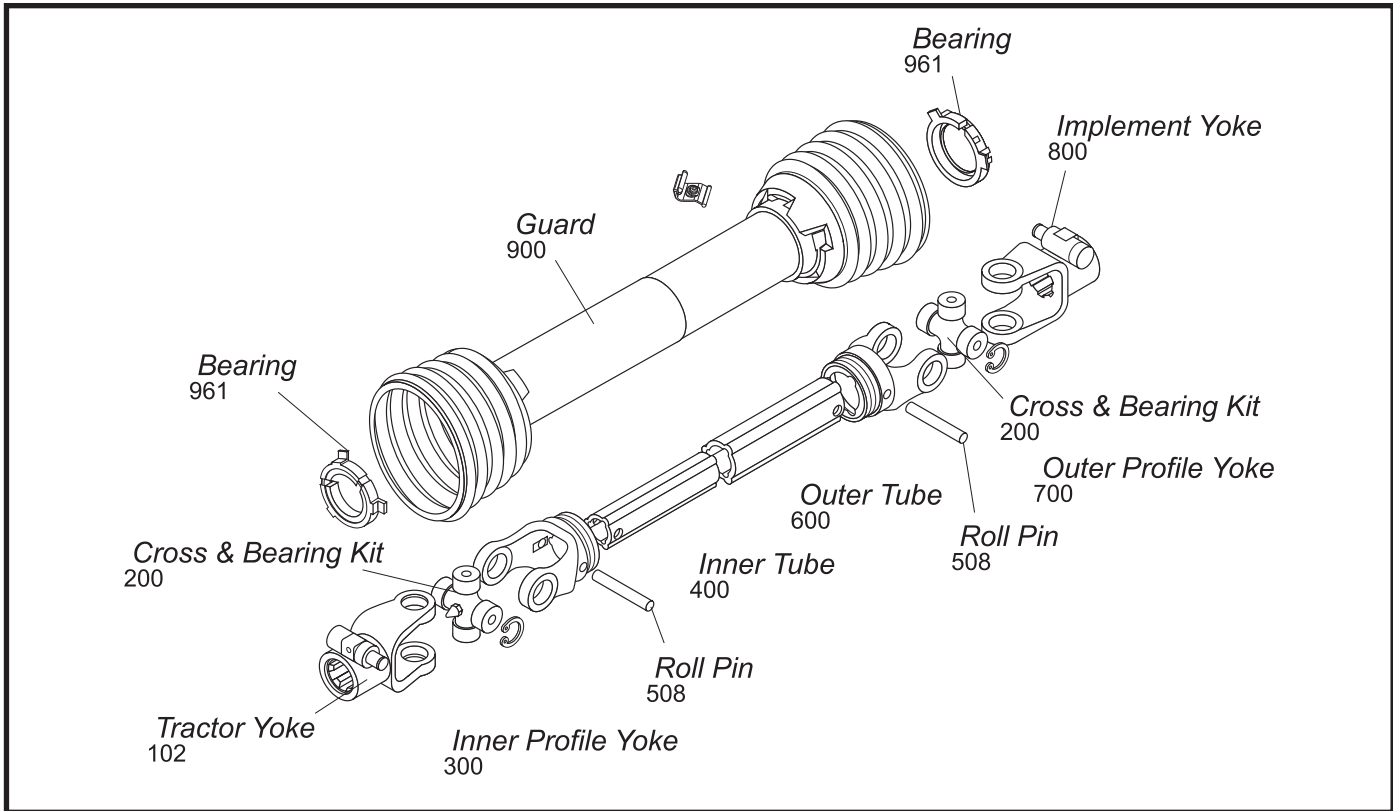

Each series has an exploded view for identification purposes. The drawing illustrates the components in the same sequence as an implement input driveline transmitting power from tractor to implement. Each component of the exploded view is identified by an eight-digit stock number to insure correct identification of each component.

Example: For metric components the 102 prefix denotes a Quick Disconnect Tractor Yoke on the exploded view.

When ordering any component in the exploded view (for any series), be sure the stock number begins with the appropriate three-digit prefix.

The digit immediately following the dash (-) will be a 6, 7 or 8.

A 6 indicates the item is interchangeable with Bondioli & Pavesi ONLY.

A 7 indicates the item is interchangeable with Walterscheid ONLY.

An 8 indicates the item is interchangeable with BOTH Bondioli & Pavesi AND Walterscheid.

This interchangeability designation is used for all components EXCEPT roll pins, guards and guard bearings.

The following chart lists the approximate size replacement for Metric Driveline. These are not an exact interchange, and should be used as a general replacement guide only.

**CROSS & BEARING KIT CROSS REFERENCE CHART FOR METRIC COMPONENTS**

<u>Cross &amp; Bearing R=Kit Stock #</u>	<u>Cross &amp; Bearing E-KIT Stock No</u>	<u>Interchanges with Bondioli &amp; Pavesi Series</u>	<u>Interchanges with Walterscheid Series</u>
200-6154	201-6154	1	N/A
200-6580	201-6580	5	N/A
200-6794	201-6794	7N	N/A
200-6806	201-6806	8	N/A
200-6908	201-6908	9	N/A
200-7004	201-7004	N/A	2600
200-7155	201-7155	N/A	2100
200-7676	201-7676	N/A	2400
200-7890	N/A	II	N/A
200-7989	201-7989	N/A	2500
200-8261	201-8261	2	2200
200-8370	201-8370	3	1
200-8474	201-8474	4	2300
200-8692	201-8692	6	220
200-8706	201-8706	7 (Old Series)	230
200-7276	201-7276	N/A	2280
200-7491	201-7491	N/A	2380
200-7694	201-7694	N/A	2480
200-7906	201-7906	N/A	2580

**DRIVELINE REPLACEMENT CHART**

<u>Weasler Series</u>	<u>Replacement for:</u>	<u>Weasler Series</u>	<u>Replacement for:</u>
6	Bondioli & Pavesi 1 & 2 Series Walterscheid 2100 & 2200 Series	35	Bondioli & Pavesi 5 Series Walterscheid 220 & 2400 Series
12	Bondioli & Pavesi 3 Series Walterscheid I Series	44	Bondioli & Pavesi 6 & 7 Series Walterscheid II Series
14	Bondioli & Pavesi 4 Series Walterscheid 2300 Series	55	Bondioli & Pavesi 8 & 9 Series Walterscheid 2500 & 2600 Series



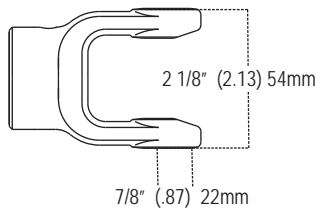

**1 Series**

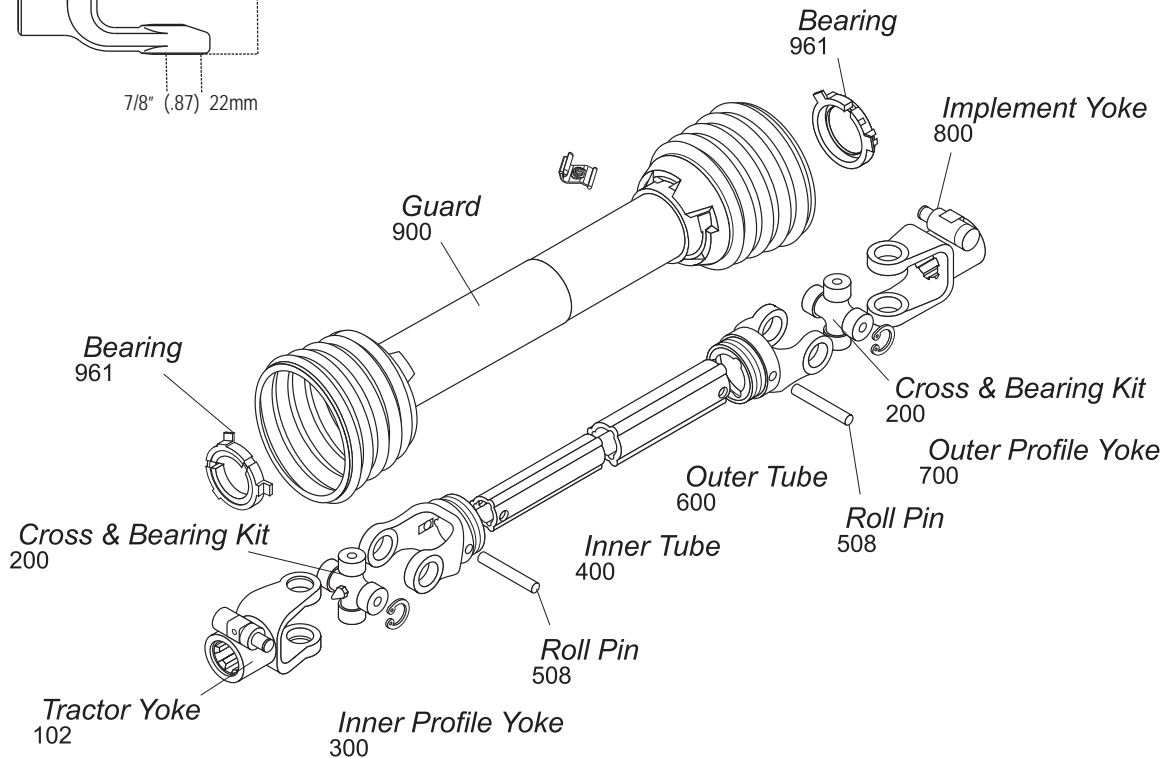

**Tractor Yoke**

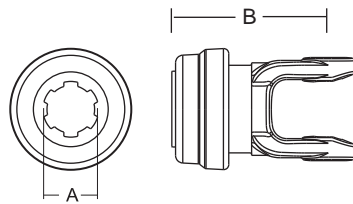

**Safety Slide Lock**  
Repair Kit — \*19-15094

Stock Number	Dim. "A"	Dim. "B"	
		mm	in.
101-6106*	1 3/8" x 6 Spl.	98.0	3.86"
101-6121*	1 3/8" x 21 Spl.	98.0	3.86"

**Cross & Bearing Kit (R-Kit)**

(Recommended 8 hour grease interval)

Snap Ring Located In Yoke

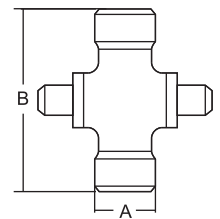

Stock Number	Dim. "A"		Dim. "B"	
	mm	in.	mm	in.
200-6154	22.0	.87"	54.0	2.13"

**Quick Disconnect**  
Repair Kit — \*13007138

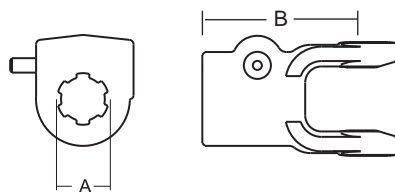

Stock Number	Dim. "A" Bore	Dim. "B"	
		mm	in.
102-6118*	1 1/8" x 6 Spl.	92.0	3.62"
102-6106*	1 3/8" x 6 Spl.	90.0	3.54"
102-6121*	1 3/8" x 21 Spl.	90.0	3.54"

**Extended Lubrication Cross & Bearing Kit (E-Kit)**

(Recommended 50 hour grease interval)

Snap Ring Located In Yoke

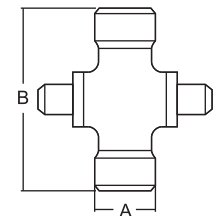

Stock Number	Dim. "A"		Dim. "B"	
	mm	in.	mm	in.
201-6154	22.0	.87"	54.0	2.13"

# 1 Series (cont'd.)

## Inner Profile Yoke

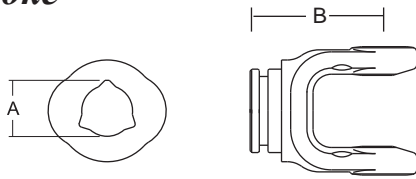

With Bearing Groove  
(Guard must rotate freely on yoke)

Stock Number	Dim. "A"		Dim. "B"	
	mm	in.	mm	in.
300-6126	27.5	1.08"	66.0	2.60"

## Outer Profile Yoke

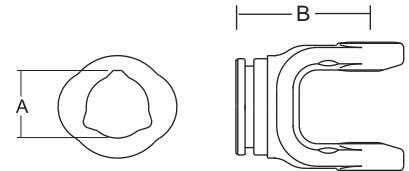

With Bearing Groove  
(Guard must rotate freely on yoke)

Stock Number	Dim. "A"		Dim. "B"	
	mm	in.	mm	in.
700-6133	33.0	1.30"	66.0	2.60"

## Inner Tube

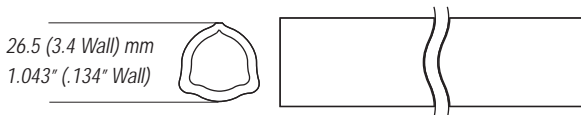

Stock Number	Length	
	m	in.
400-6126	1.5	59.06"
404-6126	1.0	39.37"

## Implement Yoke

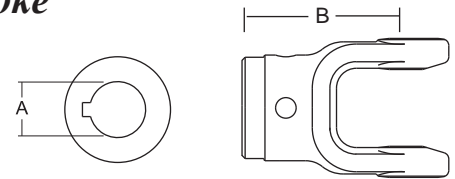

Round Bore  
With Keyway & Set Screw

Stock Number	Dim. "A"		Dim. "B"		Standard Keyway	
	mm	in.	mm	in.	mm	in.
800-6108	25.4	1.0"	78.0	3.07"	6.35	.25"
800-6110	31.75	1.25"	78.0	3.07"	6.35	.25"
800-6130	30.0	1.18"	78.0	3.07"	10.0	.39"

## Roll Pin

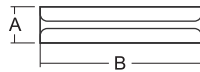

Stock Number	Dim. "A"		Dim. "B"	
	mm	in.	mm	in.
508-0850	8.0	.31"	50.0	1.97"

## Outer Tube

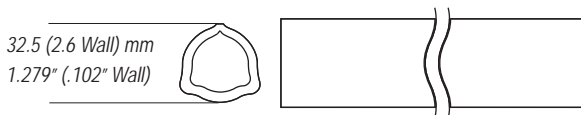

Stock Number	Length	
	m	in.
600-6133	1.5	59.06"
604-6133	1.0	39.37"

Shear Pin  
With Pin Hole

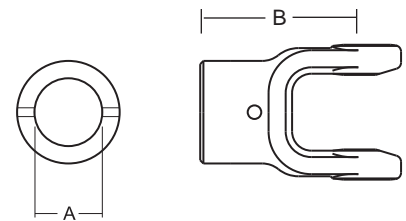

Stock Number	Dim. "A"		Dim. "B"		Pinhole	
	mm	in.	mm	in.	mm	in.
802-6110	31.75	1.25"	78.0	3.07"	6.35	.25"

# 1 Series (cont'd.)

## Guard

Order Bearings As Required

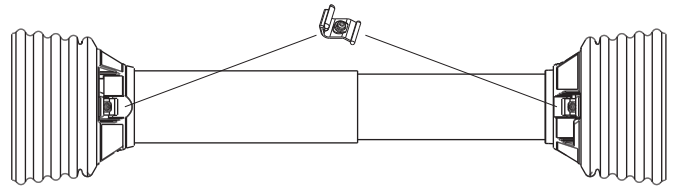

Stock

Number	Fits Overall Driveline Length	Bearing Kit (2-per kit)
900-2548	48"	961-5029
900-2560	60"	961-5029

Assembly instructions included with guard bearing kit

NOTE: Guards must rotate freely on yokes

## Easy Lock™ Replacement Kit

Part Number: 13005000 (4-per Kit)



## Guard Chain Kit

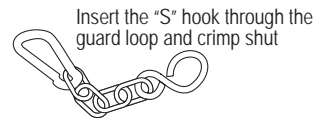

Insert the "S" hook through the guard loop and crimp shut

Part Number: 13006500 (2-per Kit)

## Driveline

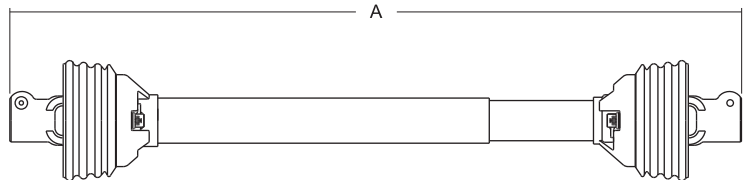

Stock Number	Overall Comp. Length Dim. "A"	Max Running Length	Tractor Yoke	Implement Yoke
14006127	27"	37"	1 3/8" x 6 Spl. QD	1 3/8" x 6 Spl. QD
**14006127ST	27"	37"	1 3/8" x 6 Spl. SSL	1 3/8" x 6 Spl. SSL
14006135	35"	50"	1 3/8" x 6 Spl. QD	1 3/8" x 6 Spl. QD
14006137	37"	53"	1 3/8" x 6 Spl. QD	1 3/8" x 6 Spl. QD
14046148	48"	70"	1 3/8" x 6 Spl. QD	*

\* Drivelines are furnished without Cross & Bearing Kit and Implement Yoke. Select kit and yoke as required.

\*\* Please see pages 22-23 for Standard driveline product details.

*Interchanges with Bondioli & Pavesi*

**AB2**

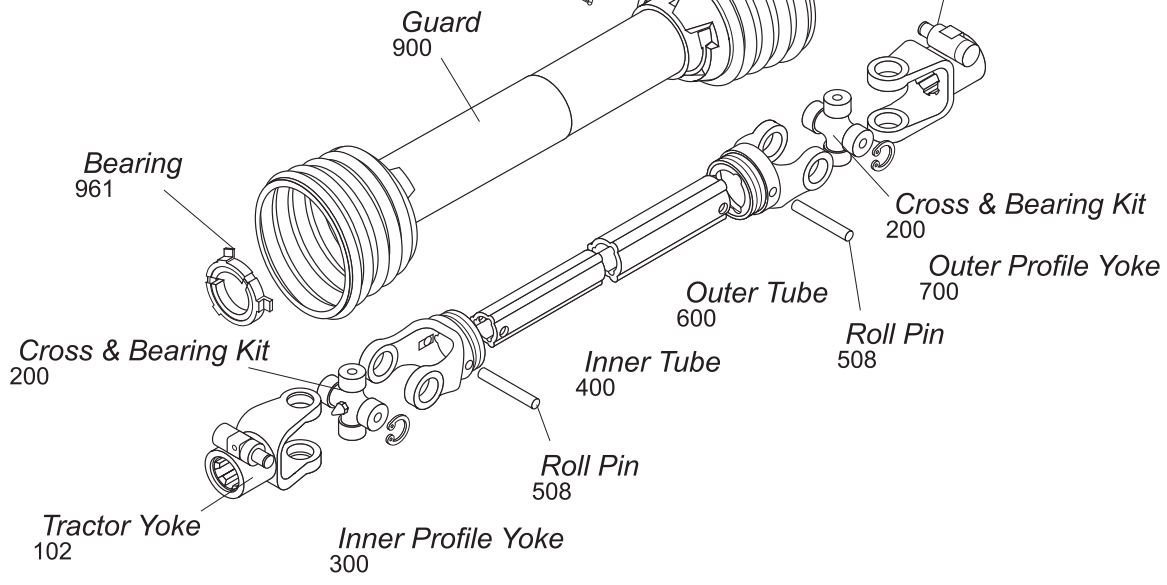
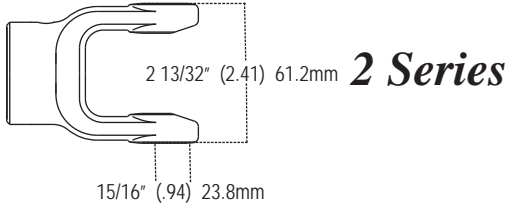

Cross & Bearing Kit and Outboard Yokes interchange with Walterscheid 2200 Series

**Tractor Yoke**

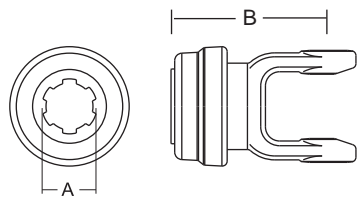

**Safety Slide Lock**  
Repair Kit — \*19-15094

Stock Number	Dim. "A"	Dim. "B"	
		mm	in.
101-8206*	1 3/8" x 6 Spl.	106.0	4.17"
101-8221*	1 3/8" x 21 Spl.	106.0	4.17"

**Cross & Bearing Kit (R-Kit)**

(Recommended 8 hour grease interval)

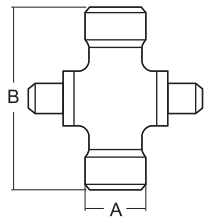

Snap Ring Located In Yoke

Stock Number	Dim. "A"		Dim. "B"	
	mm	in.	mm	in.
200-8261	23.8	.94"	61.2	2.41"

**Quick Disconnect**  
Repair Kit — \*13007138

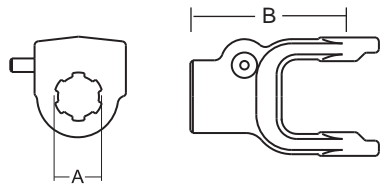

Stock Number	Dim. "A"	Dim. "B"	
		mm	in.
102-8218*	1 1/8" x 6 Spl.	94.0	3.70"
102-8206*	1 3/8" x 6 Spl.	98.0	3.86"
102-8221*	1 3/8" x 21 Spl.	98.0	3.86"

**Extended Lubrication Cross & Bearing Kit (E-Kit)**

(Recommended 50 hour grease interval)

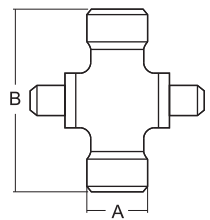

Snap Ring Located In Yoke

Stock Number	Dim. "A"		Dim. "B"	
	mm	in.	mm	in.
201-8261	23.8	.94"	61.2	2.41"

## 2 Series (cont'd.)

### Inner Profile Yoke

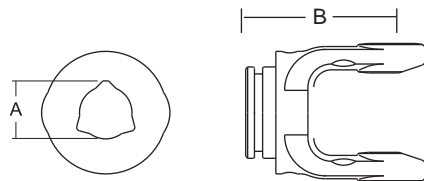

With Bearing Groove  
(Guard must rotate freely on yoke)

Stock Number	Dim. "A"		Dim. "B"	
	mm	in.	mm	in.
300-6229	29.8	1.17"	75.0	2.95"

### Outer Profile Yoke

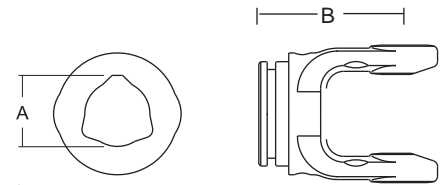

With Bearing Groove  
(Guard must rotate freely on yoke)

Stock Number	Dim. "A"		Dim. "B"	
	mm	in.	mm	in.
700-6236	36.8	1.45"	75.0	2.95"

### Inner Tube

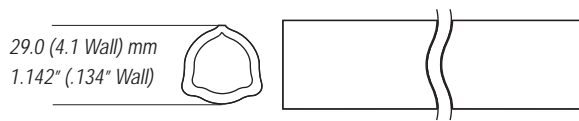

29.0 (4.1 Wall) mm  
1.142" (.134" Wall)

Stock Number	Length	
	m	in.
400-6229	1.5	59.06"
404-6229	1.0	39.37"

### Implement Yoke

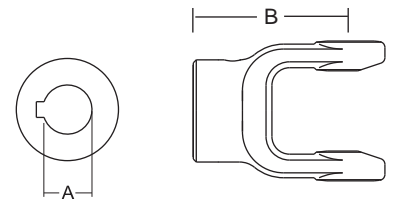

Round Bore  
With Keyway & Set Screw

Stock Number	Dim. "A"		Dim. "B"		Standard Keyway	
	mm	in.	mm	in.	mm	in.
800-8225	25.0	.98"	80.0	3.15"	8.0	.31"
800-8208	25.0	1.0"	80.0	3.15"	6.35	.25"
800-8218	28.6	1.13"	80.0	3.15"	6.35	.25"
800-8230	30.0	1.18"	80.0	3.15"	8.0	.31"
800-8210	31.8	1.25"	80.0	3.15"	6.35	.25"
800-8220	31.8	1.25"	80.0	3.15"	8.0	.31"
800-8211	34.9	1.38"	80.0	3.15"	8.0	.31"

### Roll Pin

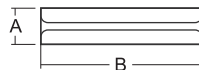

Stock Number	Dim. "A"		Dim. "B"	
	mm	in.	mm	in.
508-0860	8.0	.31"	60.00	2.36"

### Outer Tube

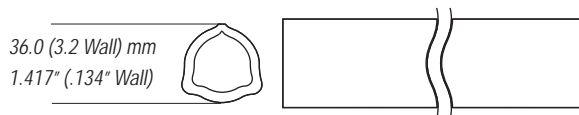

36.0 (3.2 Wall) mm  
1.417" (.134" Wall)

Stock Number	Length	
	m	in.
600-6236	1.5	59.06"
604-6236	1.0	39.37"

### Shear Pin Yoke

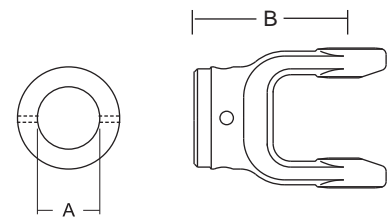

With Pinhole

Stock Number	Dim. "A"		Dim. "B"		Pinhole	
	mm	in.	mm	in.	mm	in.
802-8220	31.8	1.25"	80.0	3.15"	6.35	.25"
802-8222	34.9	1.38"	92.0	3.62"	12.9	.50"

**Guard**

Order Bearings As Required

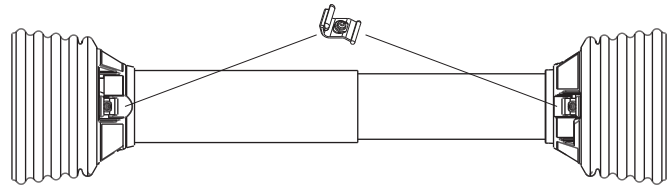

Stock Number	Fits Overall Driveline Length	Bearing Kit (2-per kit)
900-2548	48"	961-2502
900-2560	60"	961-2502

Assembly instructions included with guard bearing kit

NOTE: Guards must rotate freely on yokes

**Easy Lock™ Replacement Kit**

Part Number: 13005000 (4-per Kit)



**Guard Chain Kit**

Insert the "S" hook through the guard loop and crimp shut



Part Number: 13006500 (2-per Kit)

**Driveline**

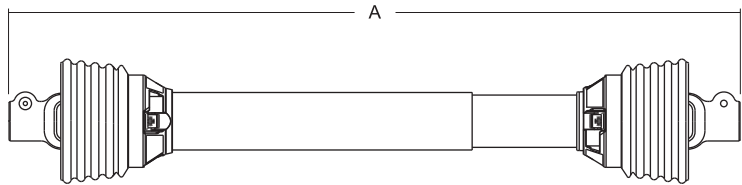

Stock Number	Overall Comp. Length Dim. "A"	Max. Running Length	Tractor Yoke	Implement Yoke
14006247	47"	70"	1 3/8" x 6 Spl. QD	1 3/8" x 6 Spl. QD
14006251	51"	76"	1 3/8" x 6 Spl. QD	1 3/8" Rd w/Pinhole
14006252	52"	79"	1 3/8" x 6 Spl. QD	1 1/4" Rd w/Pinhole
14046248	48"	70"	1 3/8" x 6 Spl. QD	*
14046260	60"	89"	1 3/8" x 6 Spl. QD	*
14106233	33"	58"	1 3/8" x 6 Spl. QD	1 3/8" x 6 Spl. w/Friction Clutch
14206252	52"	77"	1 3/8" x 6 Spl. QD	1 3/8" x 6 Spl. w/Radial Pin Clutch
14406231	31"	41"	1 3/8" x 6 Spl. Safety Side Lock	1" Rd. w/1/4" Key Ball Shear

\*Drivelines are furnished without Cross & Bearing Kit and Implement Yoke. Select kit and yoke as required.

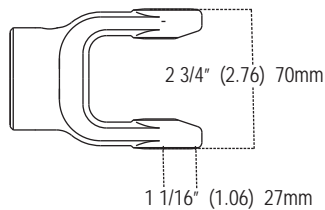

**3 Series**

*Interchanges with Bondioli & Pavesi*

**AB3**

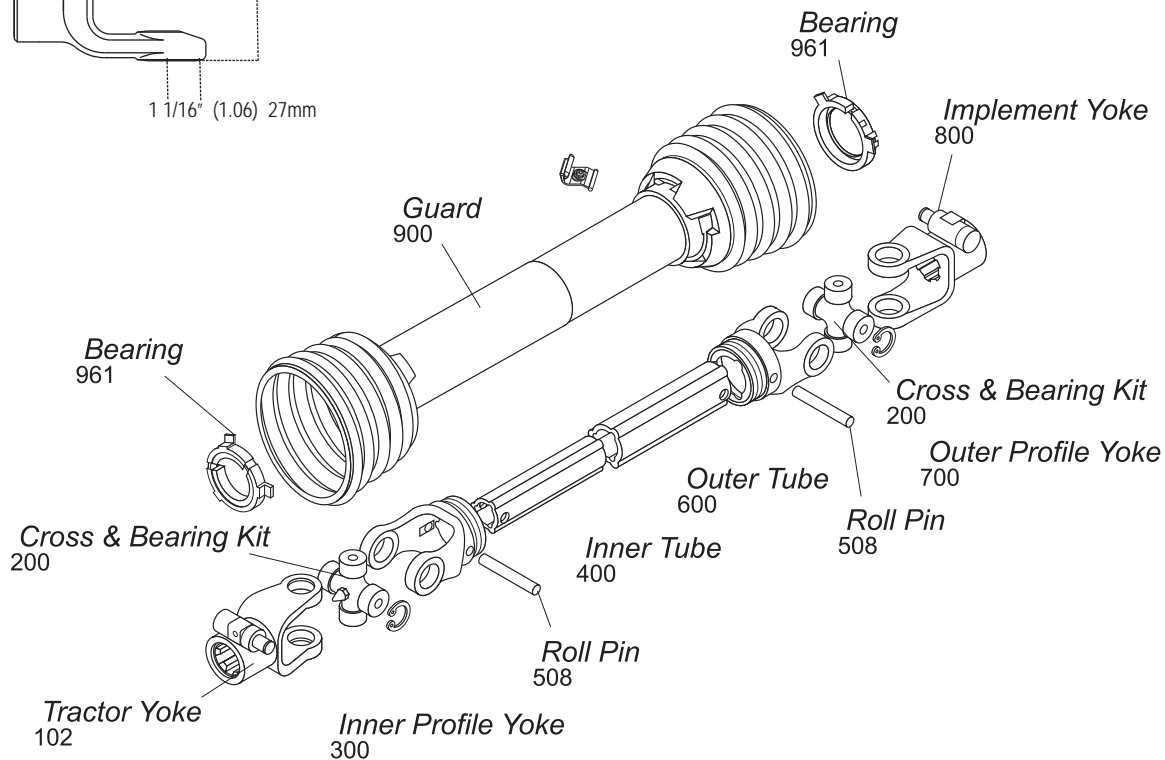

Cross & Bearing Kit and Outboard Yokes interchange with Walterscheid I Series.

**Tractor Yoke**

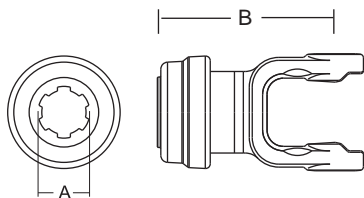

**Safety Slide Lock**  
Repair Kit — \*19-15094

Stock Number	Dim. "A"	Dim. "B"	
		mm	in.
101-8306*	1 3/8" x 6 Spl.	120.0	4.72"
101-8321*	1 3/8" x 21 Spl.	120.0	4.72"

**Cross & Bearing Kit (R-Kit)**

(Recommended 8 hour grease interval)

Snap Ring Located In Yoke

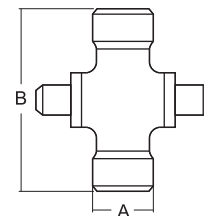

Stock Number	Dim. "A"		Dim. "B"	
	mm	in.	mm	in.
200-8370	27.0	1.06"	70.0	2.76"

**Quick Disconnect**  
Repair Kit — \*13007138

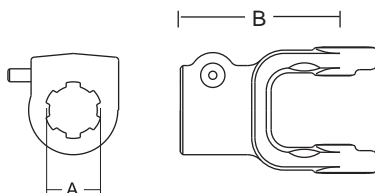

Stock Number	Dim. "A"	Dim. "B"	
		mm	in.
102-8306*	1 3/8" x 6 Spl.	102.0	4.02"
102-8321*	1 3/8" x 21 Spl.	102.0	4.02"

**Extended Lubrication Cross & Bearing Kit (E-Kit)**

(Recommended 50 hour grease interval)

Snap Ring Located In Yoke

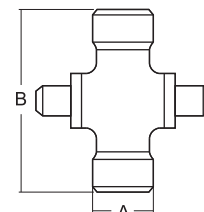

Stock Number	Dim. "A"		Dim. "B"	
	mm	in.	mm	in.
201-8370	27.0	1.06"	70.0	2.76"

**Inner Profile Yoke**

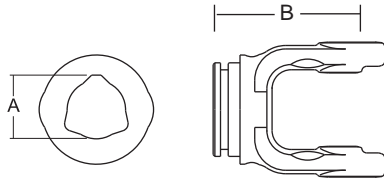

With Bearing Groove  
(Guard must rotate freely on yoke)

Stock Number	Dim. "A"		Dim. "B"	
	mm	in.	mm	in.
300-6336	36.8	1.45"	80.0	3.15"

**Outer Profile Yoke**

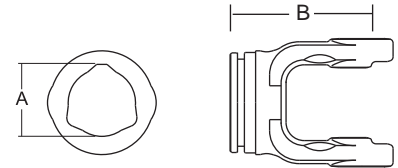

With Bearing Groove  
(Guard must rotate freely on yoke)

Stock Number	Dim. "A"		Dim. "B"	
	mm	in.	mm	in.
700-6343	44.0	1.73"	80.0	3.15"

**Inner Tube**

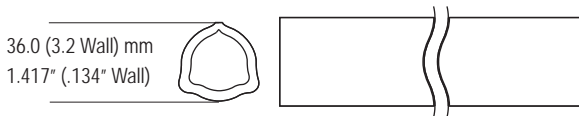

Stock Number	Length	
	m	in.
600-6236	1.5	59.06"
604-6236	1.0	39.37"

**Implement Yoke**

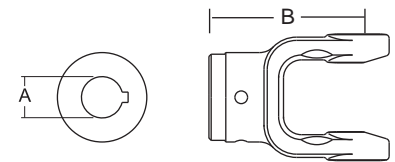

Round Bore  
With Keyway & Set Screw

Stock Number	Dim. "A"		Dim. "B"		Standard Keyway	
	mm	in.	mm	in.	mm	in.
800-8310	31.8	1.25"	92.0	3.62"	6.4	.25"
800-8311	34.9	1.38"	92.0	3.62"	8.0	.31"
800-8325	25.0	.98"	92.0	3.62"	8.0	.31"
800-8330	30.0	1.18"	92.0	3.62"	8.0	.31"

**Roll Pin**

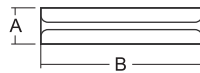

Stock Number	Dim. "A"		Dim. "B"	
	mm	in.	mm	in.
508-0860	8.0	.31"	60.0	2.36"

**Outer Tube**

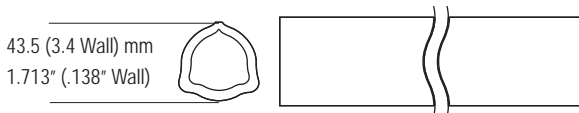

Stock Number	Length	
	m	in.
600-6343	1.5	59.06"
604-6343	1.0	39.37"

Shear Pin  
With Pin Hole

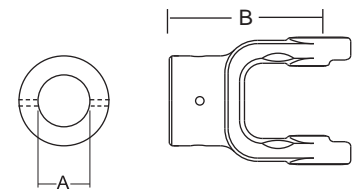

Stock Number	Dim. "A"		Dim. "B"		Pinhole	
	mm	in.	mm	in.	mm	in.
802-8310	31.8	1.25"	92.0	3.62"	6.35	.25"
802-8325	25.0	.98"	92.0	3.62"	8.00	.315"
802-8330	30.0	1.18"	92.0	3.62"	10.00	.394"
802-8335	34.9	1.38"	92.0	3.62"	12.90	.50"



## 3 Series (cont'd.)

### Guard

Order Bearings As Required

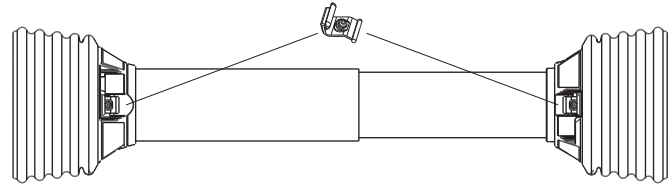

Stock

Number	Fits Overall Driveline Length	Bearing Kit (2-per kit)
900-2548	48"	961-2534
900-2560	60"	961-2534

Assembly instructions included with guard bearing kit

NOTE: Guards must rotate freely on yokes

### Easy Lock™ Replacement Kit

Part Number: 13005000 (4-per Kit)



### Guard Chain Kit

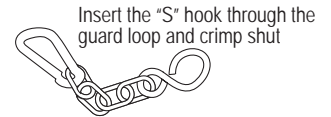

Part Number: 13006500 (2-per Kit)

### Driveline

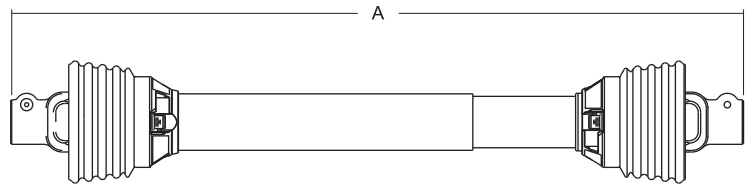

Stock Number	Overall Comp. Length Dim. "A"	Max. Running Length	Tractor Yoke	Implement Yoke
14006340	40"	57"	1 3/8" x 6 Spl. QD	1 3/8" x 6 Spl. QD
**14006340ST	40"	57"	1 3/8" x 6 Spl. SSL	1 3/8" x 6 Spl. SSL
14046348	48"	70"	1 3/8" x 6 Spl. QD	*
14046360	60"	90"	1 3/8" x 6 Spl. QD	*

\* Drivelines are furnished without Cross & Bearing Kit and Implement Yoke. Select kit and yoke as required.

\*\* Please see pages 22-23 for Standard driveline product details.

Interchanges with Bondioli & Pavesi

AB4

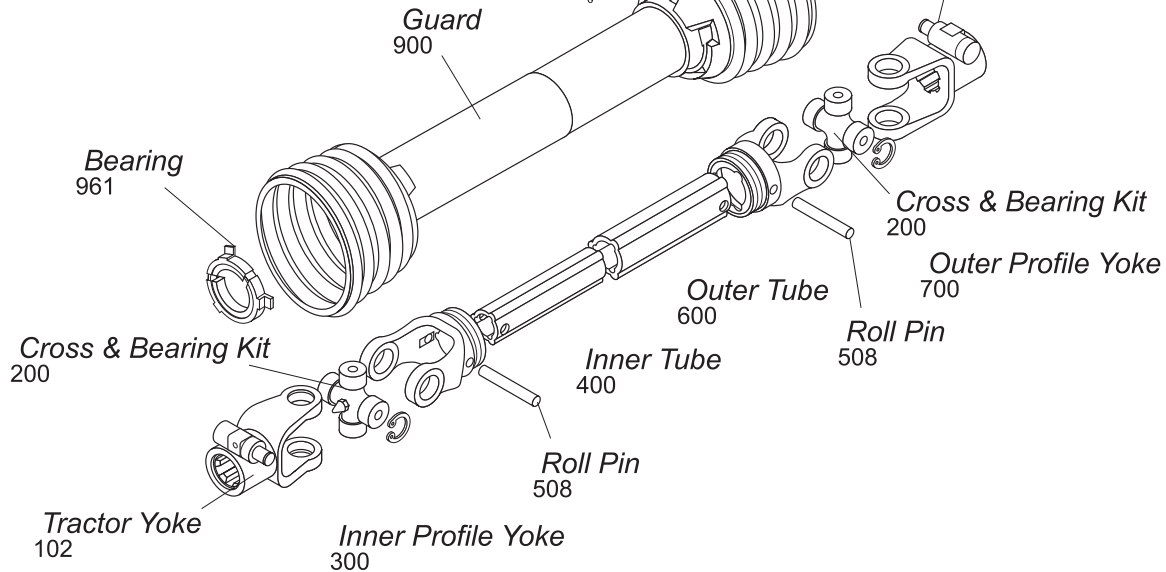
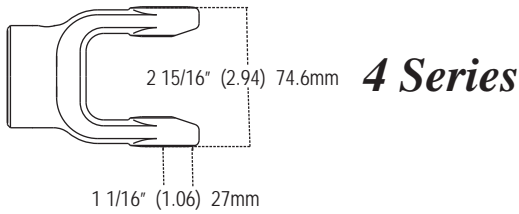

Cross & Bearing Kit and Outboard Yokes interchange with Walterscheid 2300 Series

### Tractor Yoke

**Safety Slide Lock**  
Repair Kit — \*19-15094

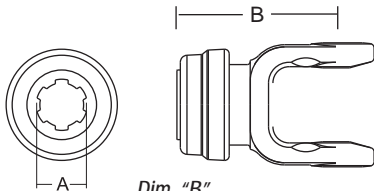

Stock Number	Dim. "A"	Dim. "B"	
		mm	in.
101-8406*	1 3/8" x 6 Spl.	113.0	4.45"
101-8421*	1 3/8" x 21 Spl.	113.0	4.45"

### Cross & Bearing Kit (R-Kit)

(Recommended 8 hour grease interval)

Snap Ring Located In Yoke

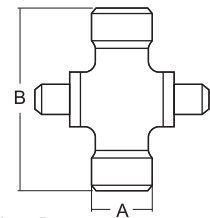

Stock Number	Dim. "A"		Dim. "B"	
	mm	in.	mm	in.
200-8474	27.0	1.06"	74.6	2.94"

**Quick Disconnect**  
Repair Kit — \*13007138

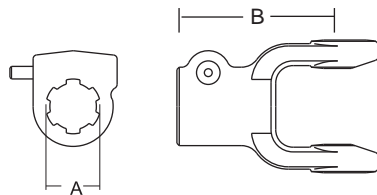

Stock Number	Dim. "A"	Dim. "B"	
		mm	in.
102-8406*	1 3/8" x 6 Spl.	107.0	4.21"
102-8418*	1 1/8" x Hex	107.0	4.21"
102-8421*	1 3/8" x 21 Spl.	107.0	4.21"

**Ball Shear**  
Repair Kit —  
\*13004000  
\*\*13004020

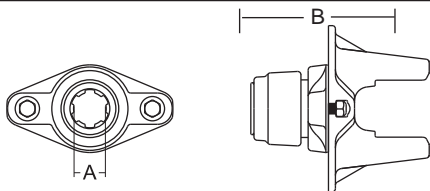

Stock Number	Dim. "A" Bore	Dim. "B"		Shear Bolt
		mm	in.	
104-8406*	1 3/8" x 6 Spl.	141.0	5.54"	3/8" - 16 Gr. 5
104-8420**	1 3/4" x 20 Spl.	154.0	6.06"	3/8" - 16 Gr. 5
104-8421*	1 3/8" x 21 Spl.	141.0	5.54"	3/8" - 16 Gr. 5

Replacement Shear Bolt Part No. 11-10445

### Extended Lubrication Cross & Bearing Kit (E-Kit)

(Recommended 50 hour grease interval)

Snap Ring Located In Yoke

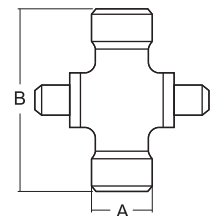

Stock Number	Dim. "A"		Dim. "B"	
	mm	in.	mm	in.
201-8474	27.0	1.06"	74.6	2.94"

## 4 Series (cont'd.)

### Inner Profile Yoke

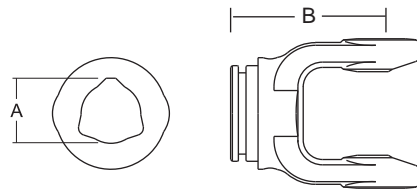

With Bearing Groove  
(Guard must rotate freely on yoke)

Stock Number	Dim. "A"		Dim. "B"	
	mm	in.	mm	in.
300-6436	36.8	1.45"	85.0	3.35"

### Inner Tube

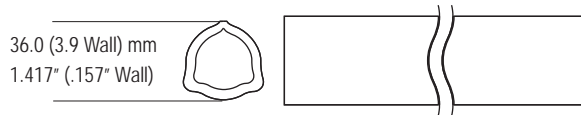

36.0 (3.9 Wall) mm  
1.417" (.157" Wall)

Stock Number	Length	
	m	in.
400-6436	1.5	59.06"
404-6436	1.0	39.37"

### Roll Pin

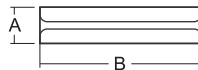

Stock Number	Dim. "A"		Dim. "B"	
	mm	in.	mm	in.
508-0860	8.0	.31"	60.0	2.36"

### Outer Tube

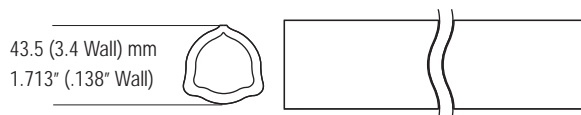

43.5 (3.4 Wall) mm  
1.713" (.138" Wall)

Stock Number	Length	
	m	in.
600-6343	1.5	59.06"
604-6343	1.0	39.37"

### Outer Profile Yoke

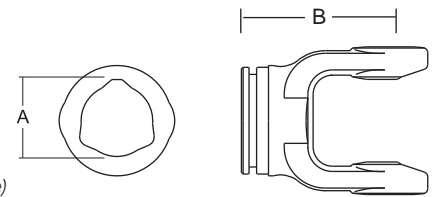

With Bearing Groove  
(Guard must rotate freely on yoke)

Stock Number	Dim. "A"		Dim. "B"	
	mm	in.	mm	in.
700-6443	44.0	1.73"	85.0	3.35"

### Implement Yoke

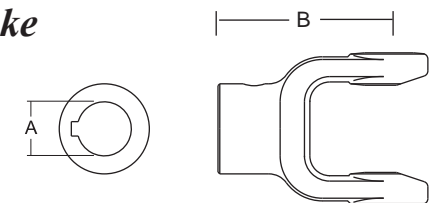

Round Bore  
With Keyway & Set Screw

Stock Number	Dim. "A"		Dim. "B"		Standard Keyway	
	mm	in.	mm	in.	mm	in.
800-8430	30.0	1.18"	95.0	3.74"	8.0	.31"
800-8410	31.8	1.25"	95.0	3.74"	6.4	.25"
800-8411	34.9	1.38"	95.0	3.74"	8.0	.31"
800-8424	38.1	1.50"	95.0	3.74"	9.5	.38"
800-8435	35.0	1.38"	95.0	3.74"	10.0	.39"

Shear Pin  
With Pin Hole

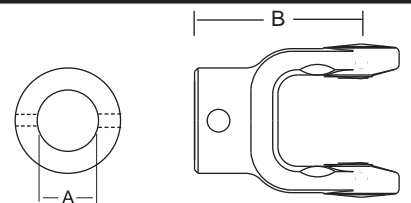

Stock Number	Dim. "A"		Dim. "B"		Pinhole	
	mm	in.	mm	in.	mm	in.
802-8410	31.8	1.25"	95.0	3.74"	6.35	.25"
802-8435	35.0	1.38"	95.0	3.74"	12.9	.50"

Hex Bore

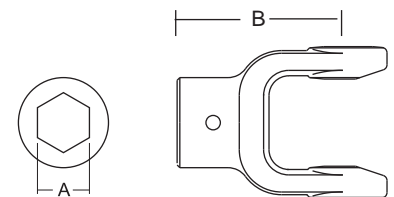

Stock Number	Dim. "A"		Dim. "B"	
	mm	in.	mm	in.
805-8418	28.9	1.14"	95.0	3.74"

Clamp Yoke

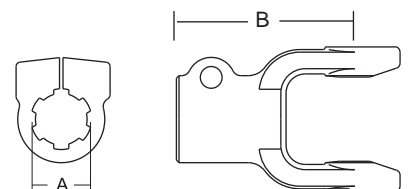

Stock Number	Dim. "A"		Dim. "B"	
	mm	in.	mm	in.
807-8406	1 3/8" x 6 Spl.		107.0	4.21"
807-8420	1 1/4" Rd.		107.0	4.21"

## Guard

Order Bearings As Required

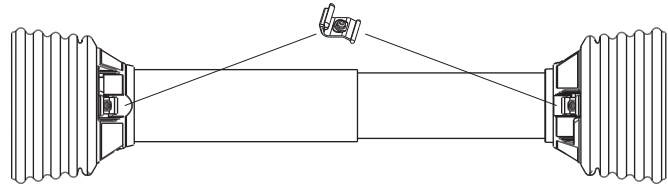

Stock Number	Fits Overall Driveline Length	Bearing Kit (2-per kit)
900-2548	48"	961-2534
900-2560	60"	961-2534

Assembly instructions included with guard bearing kit

NOTE: Guards must rotate freely on yokes

## Guard Chain Kit

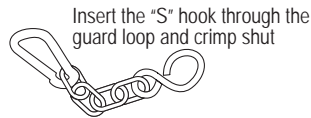

Part Number: 13006500 (2-per Kit)

## Easy Lock™ Replacement Kit

Part Number: 13005000 (4-per Kit)



## Driveline

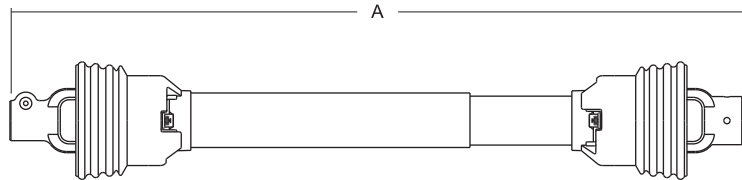

Stock Number	Overall Comp. Length Dim. "A"	Max. Running Length	Tractor Yoke	Implement Yoke
14006424	48"	70"	1 3/8" x 6 Spl. QD	1 1/2" Rd. w/3/8" Keyway
14006430	30"	40"	1 3/8" x 6 Spl. QD	1 3/8" Rd. w/Pinhole
**14006430ST	30"	40"	1 3/8" x 6 Spl. SSL	1 3/8" Rd. w/Pinhole
14006432	32"	43"	1 3/8" x 6 Spl. QD	1 3/8" Rd. w/Pinhole
**14006432ST	32"	43"	1 3/8" x 6 Spl. SSL	1 3/8" Rd. w/Pinhole
14006436	36"	50"	1 3/8" x 6 Spl. QD	1 3/8" Rd. w/Pinhole
14006437	37"	50"	1 3/8" x 6 Spl. QD	1 3/8" Rd. w/Pinhole
**14006437ST	37"	50"	1 3/8" x 6 Spl. SSL	1 3/8" Rd. w/Pinhole
14006438	38"	53"	1 3/8" x 6 Spl. QD	1 3/8" x 6 Spl. QD
14006442	42"	60"	1 3/8" x 6 Spl. QD	1 3/8" Rd. w/Pinhole
**14006442ST	42"	60"	1 3/8" x 6 Spl. SSL	1 3/8" Rd. w/Pinhole
14006444	52"	77"	1 3/8" x 6 Spl. QD	1 3/8" x 6 Spl. QD
14006446	46"	67"	1 3/8" x 6 Spl. QD	1 3/8" x 6 Spl. QD
14006448	48"	70"	1 3/8" x 6 Spl. QD	1 3/8" x 6 Spl. QD
**14006448ST	48"	70"	1 3/8" x 6 Spl. SSL	1 3/8" x 6 Spl. SSL
14006451	51"	76"	1 3/8" x 6 Spl. QD	1 3/8" Rd. w/Pinhole
14006453	53"	79"	1 3/8" x 6 Spl. QD	1 1/4" Rd. w/Pinhole
**14006453ST	53"	79"	1 3/8" x 6 Spl. SSL	1 1/4" Rd. w/Pinhole
14006455	55"	83"	1 3/8" x 6 Spl. QD	1 3/8" x 6 Spl. QD
14046448	48"	70"	1 3/8" x 6 Spl. QD	*
14046460	60"	89"	1 3/8" x 6 Spl. QD	*
14106436	36"	48"	1 3/8" x 6 Spl. QD	1 3/8" x 6 Spl. w/Friction Clutch
**14106436ST	36"	48"	1 3/8" x 6 Spl. SSL	1 3/8" x 6 Spl. w/Friction Clutch
14106438	38"	52"	1 3/8" x 6 Spl. QD	1 3/8" x 6 Spl. w/Friction Clutch
14206454	54"	79"	1 3/8" x 6 Spl. QD	1 3/8" x 6 Spl. w/Radial Pin Clutch
14406428	28"	35"	1 3/8" x 6 Spl. Safety Slide Lock	1 1/4" Rd. w/1/4" Keyway Ball Shear

\* Drivelines are furnished without Cross & Bearing Kit and Implement Yoke. Select kit and yoke as required.

\*\* Please see pages 22-23 for Standard driveline product details.

**5 Series**

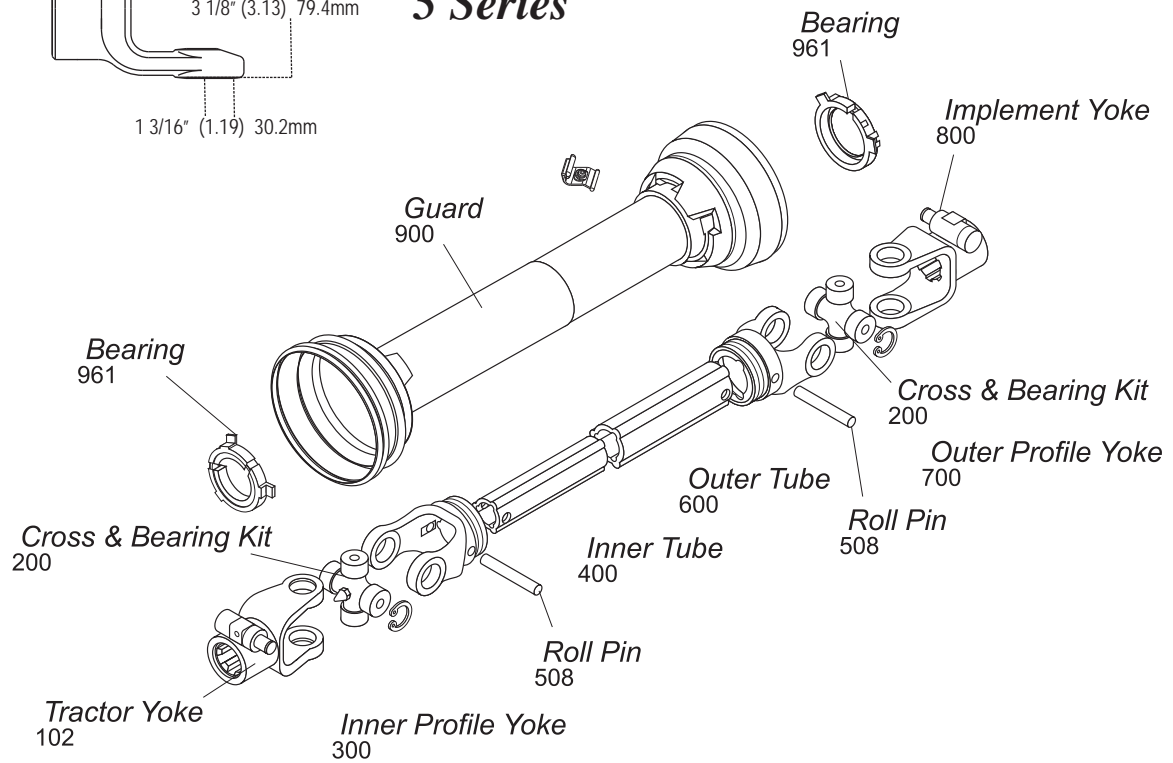
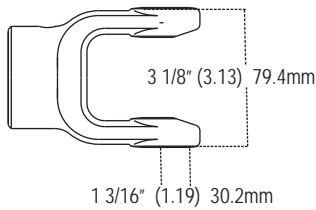

**Tractor Yoke**

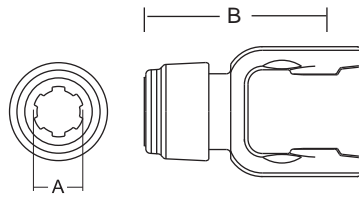

**Safety Slide Lock**  
Repair Kit — \*13004000

Stock Number	Dim. "A"	Dim. "B"	
		mm	in.
101-6506*	1 3/8" x 6 Spl.	126.0	4.96"
101-6521*	1 3/8" x 21 Spl.	126.0	4.96"

**Cross & Bearing Kit (R-Kit)**

(Recommended 8 hour grease interval)

Snap Ring Located In Yoke

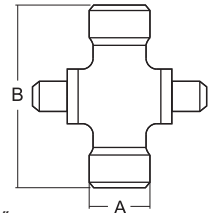

Stock Number	Dim. "A"		Dim. "B"	
	mm	in.	mm	in.
200-6580	30.2	1.19"	79.4	3.13"

**Quick Disconnect**

Repair Kit —  
\*13007138  
\*\*13007120

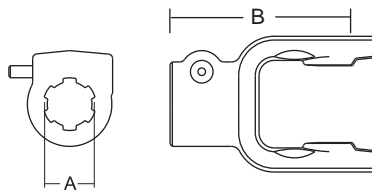

Stock Number	Dim. "A" Bore	Dim. "B"	
		mm	in.
102-6506*	1 3/8" x 6 Spl.	113.0	4.45"
102-6520**	1 3/4" x 20 Spl.	116.0	4.57"
102-6521*	1 3/8" x 21 Spl.	113.0	4.45"

**Ball Shear**

Repair Kit —  
\*13004000  
\*\*13004020

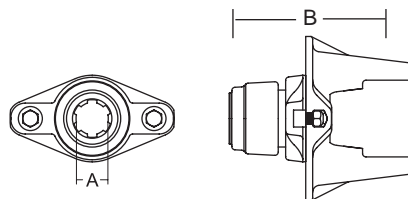

Stock Number	Dim. "A" Bore	Dim. "B"		Shear Bolt
		mm	in.	
104-6506*	1 3/8" x 6 Spl.	141.0	5.54"	3/8" - 16 Gr. 5
104-6520**	1 3/4" x 20 Spl.	154.0	6.06"	3/8" - 16 Gr. 5
104-6521*	1 3/8" x 21 Spl.	141.0	5.54"	3/8" - 16 Gr. 5

**Extended Lubrication Cross & Bearing Kit (E-Kit)**

(Recommended 50 hour grease interval)

Snap Ring Located In Yoke

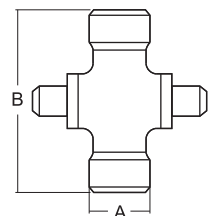

Stock Number	Dim. "A"		Dim. "B"	
	mm	in.	mm	in.
201-6580	30.2	1.19"	79.4	3.13"

**Inner Profile Yoke**

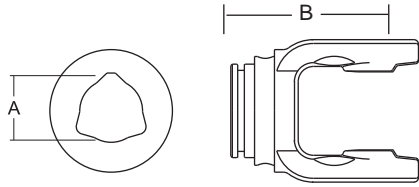

With Bearing Groove  
(Guard must rotate freely on yoke)

Stock Number	Dim. "A"		Dim. "B"	
	mm	in.	mm	in.
300-6545	45.2	1.78"	98.0	3.86"

**Outer Profile Yoke**

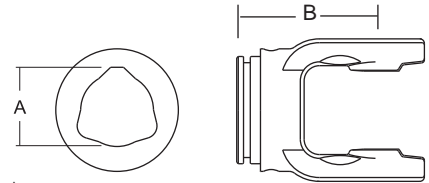

With Bearing Groove  
(Guard must rotate freely on yoke)

Stock Number	Dim. "A"		Dim. "B"	
	mm	in.	mm	in.
700-6552	51.7	2.04"	98.0	3.86"

**Inner Tube**

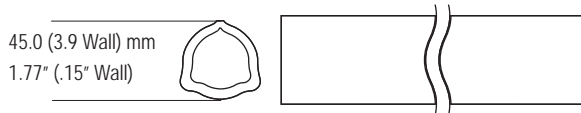

Stock Number	Length	
	m	in.
400-6545	1.5	59.06"
404-6545	1.0	39.37"

**Implement Yoke**

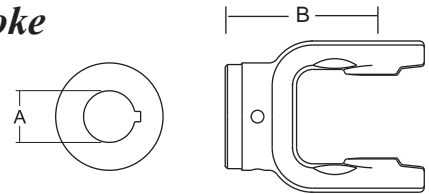

Round Bore  
With Keyway & Set Screw

Stock Number	Dim. "A"		Dim. "B"		Standard Keyway	
	mm	in.	mm	in.	mm	in.
800-6510	31.8	1.25"	98.0	3.86"	6.4	.25"
800-6511	34.9	1.38"	98.0	3.86"	8.0	.31"
800-6524	38.1	1.50"	98.0	3.86"	9.5	.38"
800-6535	35.0	1.378"	98.0	3.86"	10.0	.39"

**Roll Pin**

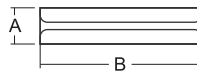

Stock Number	Dim. "A"		Dim. "B"	
	mm	in.	mm	in.
508-1075	10.0	.394"	75.0	2.95"

**Shear Pin**  
With Pin Hole

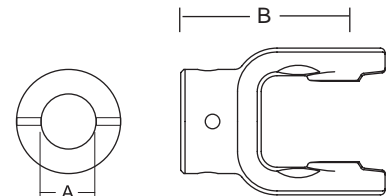

Stock Number	Dim. "A"		Dim. "B"		Pinhole	
	mm	in.	mm	in.	mm	in.
802-6535	34.9	1.38"	105.0	4.13"	12.9	.50"

**Outer Tube**

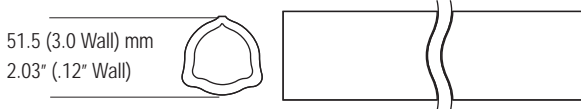

Stock Number	Length	
	m	in.
600-6552	1.5	59.06"
604-6552	1.0	39.37"

**Clamp Yoke**

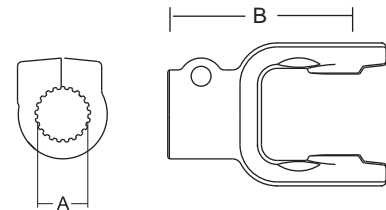

Stock Number	Dim. "A"		Dim. "B"	
	mm	in.	mm	in.
807-6521	35.0	1.38" x 21 Spl.	113.0	4.45"

## 5 Series (cont'd.)

### Guard

Order Bearings As Required

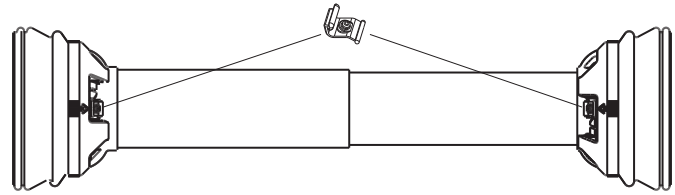

Stock Number	Fits Overall Driveline Length	Bearing Kit (2-per kit)
902-3548	48"	961-3505
902-3560	60"	961-3505

Assembly instructions included with guard bearing kit  
NOTE: Guards must rotate freely on yokes

### Easy Lock™ Replacement Kit

Part Number: 13005000 (4-per Kit)



### Guard Chain Kit

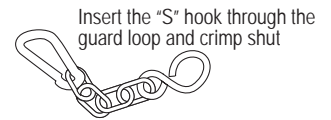

Part Number: 13006500 (2-per Kit)

### Driveline

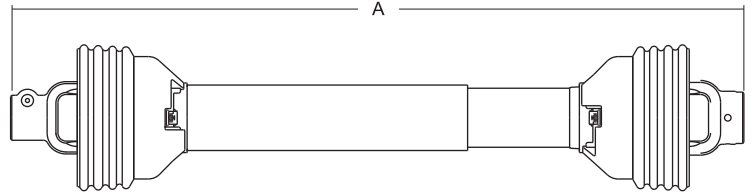

Stock Number	Overall Comp. Length Dim. "A"	Max. Running Length	Tractor Yoke	Implement Yoke
14006524	48"	70"	1 3/8" x 6 Spl. QD	1 1/2" Rd. w/3/8" Keyway
14006542	42"	60"	1 3/8" x 6 Spl. QD	1 3/8" Rd. w/Pinhole
**14006542ST	42"	60"	1 3/8" x 6 Spl. SSL	1 3/8" Rd. w/Pinhole
14006543	43"	60"	1 3/8" x 6 Spl. QD	1 3/8" x 6 Spl. QD
14006546	46"	67"	1 3/8" x 6 Spl. QD	1 3/8" x 6 Spl. QD
**14006546ST	46"	67"	1 3/8" x 6 Spl. SSL	1 3/8" x 6 Spl. SSL
14006551	51"	76"	1 3/8" x 6 Spl. QD	1 3/8" Rd. w/Pinhole
14006555	55"	83"	1 3/8" x 6 Spl. QD	1 3/8" x 6 Spl. QD
14016524	48"	70"	1 3/8" x 21 Spl. QD	1 1/2" Rd. w/3/8" Keyway
14016536	36"	50"	1 3/8" x 6 Spl. QD	1 3/8" x 6 Spl. QD
14016542	42"	60"	1 3/8" x 6 Spl. QD	1 3/8" x 6 Spl. QD
14046548	48"	70"	1 3/8" x 6 Spl. QD	*
14046560	60"	89"	1 3/8" x 6 Spl. QD	*
14106546	46"	65"	1 3/8" x 6 Spl. QD	1 3/8" X 6 Spl. w/Friction Clutch
14306538	38"	55"	1 3/8" x 6 Spl. QD	1 3/8" x 6 Spl. w/Overrunning Clutch

\* Drivelines are furnished without Cross & Bearing Kit and Implement Yoke. Select kit and yoke as required.

\*\* Please see pages 22-23 for Standard driveline product details.

*Interchanges with Bondioli & Pavesi*

# 6 Series

**AB6**

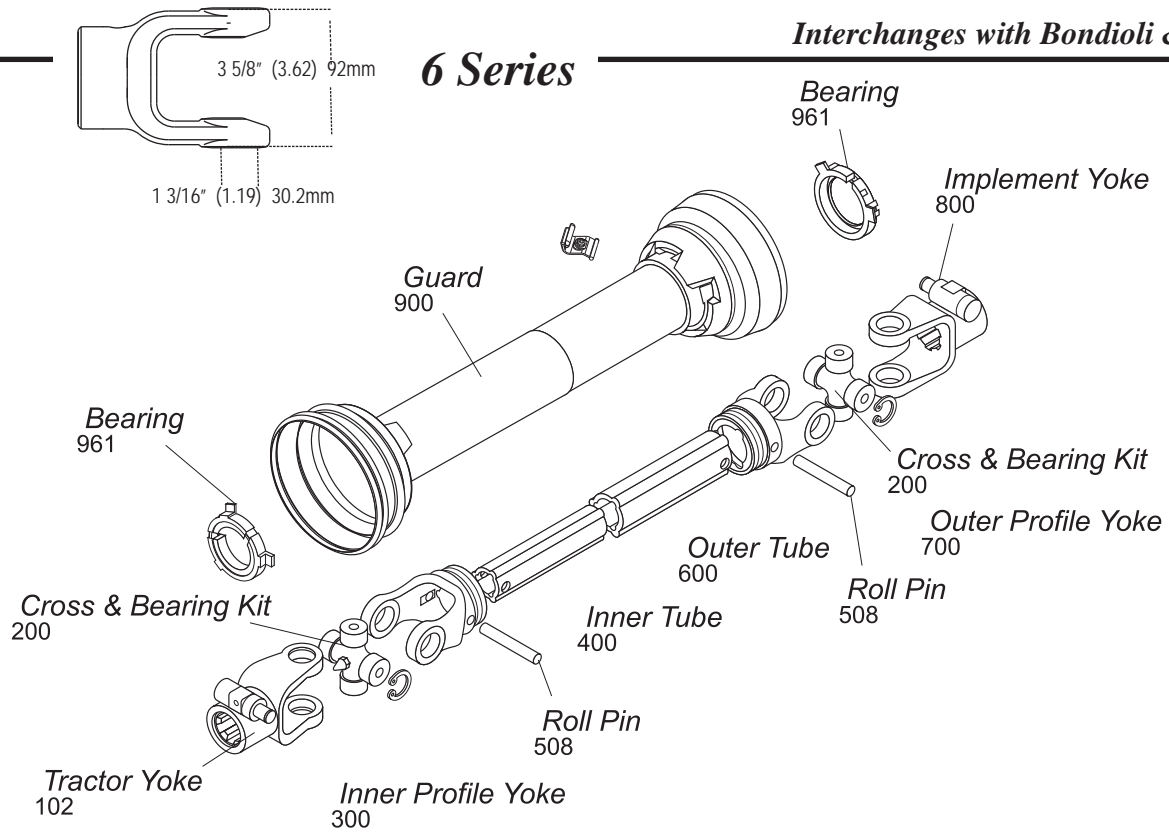

Cross & Bearing Kit and Outboard Yokes interchange with Walterscheid 220 Series

## Tractor Yoke

### Safety Slide Lock

Repair Kit —  
\*13004000  
\*\*13004020

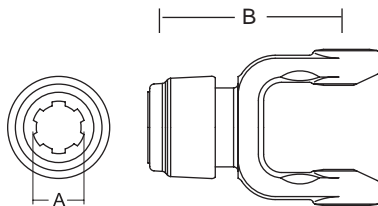

### Ball Shear

Repair Kit —  
\*13004000  
\*\*13004020

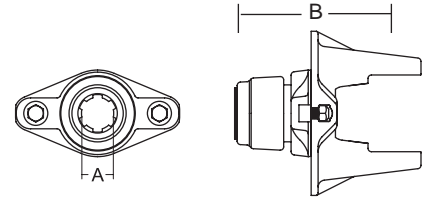

Stock Number	Dim. "A" Bore	Dim. "B" mm	in.
101-8606*	1 3/8" x 6 Spl.	132.0	5.20"
101-8620**	1 3/4" x 20 Spl.	135.0	5.32"
101-8621*	1 3/8" x 21 Spl.	132.0	5.20"

Stock Number	Dim. "A" Bore	Dim. "B" mm	in.	Shear Bolt
104-8606*	1 3/8" x 6 Spl.	149.0	5.85"	3/8" - 16 Gr. 5
104-8620**	1 3/4" x 20 Spl.	162.0	6.37"	3/8" - 16 Gr. 5
104-8621*	1 3/8" x 21 Spl.	149.0	5.85"	3/8" - 16 Gr. 5

**Replacement Shear Bolt Part No. 11-10445**

## Quick Disconnect

Repair Kit —  
\*13007138  
\*\*13007120

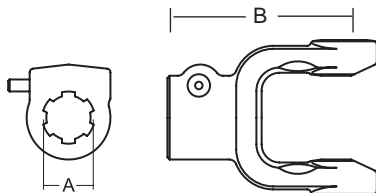

Stock Number	Dim. "A" Bore	Dim. "B" mm	in.
102-8606*	1 3/8" x 6 Spl.	118.0	4.65"
102-8618*	1 1/8" Hex	117.0	4.61"
102-8620**	1 3/4" x 20 Spl.	120.0	4.72"
102-8621*	1 3/8" x 21 Spl.	118.0	4.65"



## 6 Series (cont'd.)

### Cross & Bearing Kit (R-Kit)

(Recommended 8 hour grease interval)

Snap Ring Located In Yoke

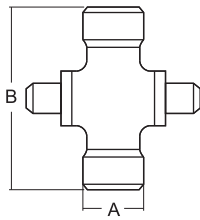

Stock Number	Dim. "A"		Dim. "B"	
	mm	in.	mm	in.
200-8692	30.2	1.19"	92.0	3.62"

### Extended Lubrication Cross & Bearing Kit (E-Kit)

(Recommended 50 hour grease interval)

Snap Ring Located In Yoke

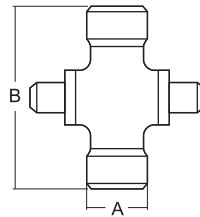

Stock Number	Dim. "A"		Dim. "B"	
	mm	in.	mm	in.
201-8692	30.2	1.19"	92.0	3.62"

### Inner Profile Yoke

With Bearing Groove  
(Guard must rotate freely on yoke)

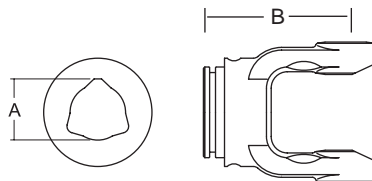

Stock Number	Dim. "A"		Dim. "B"	
	mm	in.	mm	in.
300-6645	45.2	1.78"	105.0	4.13"

### Inner Tube

45.0 (3.9 Wall) mm  
1.77" (.154" Wall)

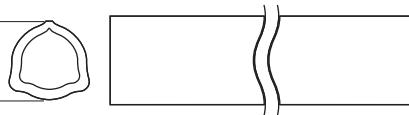

Stock Number	Length	
	m	in.
400-6545	1.5	59 1/16" (59.06)
404-6545	1.0	39 3/8" (39.37)

### Roll Pin

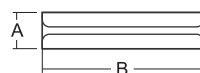

Stock Number	Dim. "A"		Dim. "B"	
	mm	in.	mm	in.
508-1080	10.0	.39"	80.0	3.15"

### Outer Tube

54.0 (4.5 Wall) mm  
2.13" (.18" Wall)



Stock Number	Length	
	m	in.
600-6654	1.5	59 1/16" (59.06)
604-6654	1.0	39 3/8" (39.37)

### Outer Profile Yoke

With Bearing Groove  
(Guard must rotate freely on yoke)

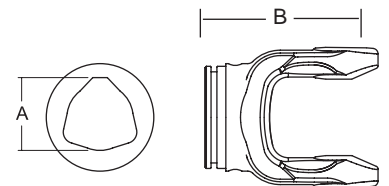

Stock Number	Dim. "A"		Dim. "B"	
	mm	in.	mm	in.
700-6654	54.2	2.13"	105.0	4.13"

### Implement Yoke

Round Bore  
With Keyway & Set Screw

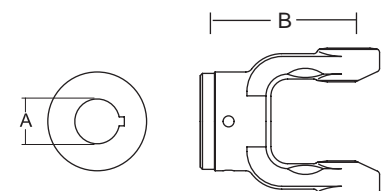

Stock Number	Dim. "A"		Dim. "B"		Standard Keyway	
	mm	in.	mm	in.	mm	in.
800-8610	31.8	1.25"	105.0	4.13"	6.4	.25"
800-8611	35.0	1.38"	105.0	4.13"	13.0	.31"
800-8624	38.1	1.50"	105.0	4.13"	9.5	.38"
800-8628	44.5	1.75"	108.0	4.25"	9.5	.38"
800-8635	35.0	1.38"	108.0	4.25"	10.0	.39"
800-8640	40.0	1.57"	108.0	4.25"	12.0	.47"

### Shear Pin

With Pin Hole

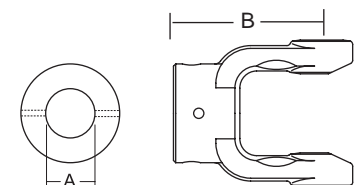

Stock Number	Dim. "A"		Dim. "B"		Pinhole	
	mm	in.	mm	in.	mm	in.
802-8611	34.9	1.38"	105.0	4.13"	12.9	.50"
802-8620	31.8	1.25"	105.0	4.13"	6.5	.25"

Implement Yoke - continued

Hex Bore

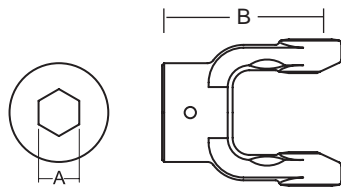

Stock Number	Dim. "A"		Dim. "B"	
	mm	in.	mm	in.
805-8618	28.9	1.14" Hex	105.0	4.13"

Clamp Yoke

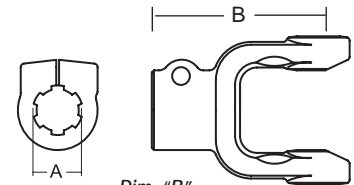

Stock Number	Dim. "A"		Dim. "B"	
			mm	in.
807-8606	1 3/8" x 6 Spl.		117.0	4.61"
807-8620	1 3/4" x 20 Spl.		120.0	4.72"
807-8621	1 3/8" x 21 Spl.		117.0	4.61"

Guard

Order Bearings As Required

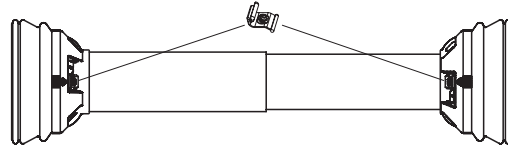

Stock Number	Fits Overall Driveline Length	Bearing Kit (2-per kit)
902-3548	48"	961-3567
902-3560	60"	961-3567

Assembly instructions included with guard bearing kit  
Note: Guards must rotate freely on yokes

Guard Chain Kit

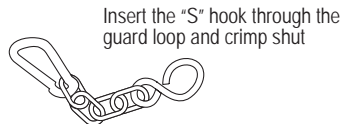

Part Number: 13006500 (2-per Kit)

Easy Lock™ Replacement Kit

Part Number: 13005000 (4-per Kit)



Driveline

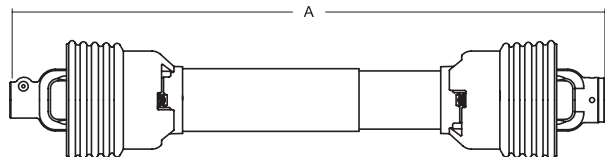

Stock Number	Overall Comp. Length Dim. "A"	Max. Running Length	Tractor Yoke	Implement Yoke
14006624	48"	70"	1 3/8" x 6 Spl. QD	1 1/2" Rd. w/3/8" Keyway
14006628	57"	83"	1 3/8" x 6 Spl. QD	1 3/4" Rd. w/3/8" Keyway
14006637	37"	50"	1 3/8" x 6 Spl. QD	1 3/8" x 6 Spl. QD
14006642	42"	57"	1 3/8" x 6 Spl. QD	1 3/8" x 6 Spl. QD
14006644	44"	60"	1 3/8" x 6 Spl. QD	1 3/8" x 6 Spl. QD
14006652	52"	76"	1 3/8" x 6 Spl. QD	1 3/8" Rd. w/Pinhole
14006655	55"	76"	1 3/8" x 6 Spl. QD	1 3/8" x 6 Spl. QD
14006657	57"	83"	1 3/8" x 6 Spl. QD	1 3/8" x 6 Spl. QD
**14006657ST	57"	83"	1 3/8" x 6 Spl. SSL	1 3/8" x 6 Spl. SSL
14016624	48"	70"	1 3/8" x 21 Spl. QD	1 1/2" Rd. w/3/8" Keyway
14016666	66"	99"	1 3/8" x 21 Spl. QD	1 3/8" Rd. w/5/16" Keyway
14046648	48"	70"	1 3/8" x 6 Spl. QD	*
14046660	60"	89"	1 3/8" x 6 Spl. QD	*
14066644	44"	60"	1 3/8" x 21 Spl. QD	1 3/8" x 21 Spl. QD
14106654	54"	78"	1 3/8" x 6 Spl. QD	1 3/8" x 6 Spl. Clamp w/Friction Clutch
14106656	56"	80"	1 3/4" x 20 Spl. Clamp	1 3/4" x 20 Spl. Clamp w/Friction Clutch
14106660	60"	89"	1 3/8" x 6 Spl. QD	1 3/4" x 20 Spl. Clamp w/Friction Clutch
14106661	61"	92"	1 3/4" x 20 Spl. QD	1 3/4" x 20 Spl. Clamp w/Friction Clutch
14106664	64"	94"	1 3/4" x 20 Spl. Clamp	1 3/4" x 20 Spl. Clamp w/Friction Clutch
14116664	64"	94"	1 3/8" x 21 Spl. Clamp	1 3/8" x 21 Spl. Clamp w/Friction Clutch
14126654	57"	82"	1 3/8" x 6 Spl. QD	1 3/4" x 20 Spl. Clamp w/Friction Clutch
14126664	64"	94"	1 3/4" x 20 Spl. Clamp	1 3/8" x 6 Spl. Clamp w/Friction Clutch
14306639	39"	52"	1 3/8" x 6 Spl. QD	1 3/8" x 6 Spl. w/Overrunning Clutch
14406632	32"	41"	1 3/8" x 6 Spl. Safety Slide Lock	1 1/2" Rd. w/3/8" Keyway Ball Shear
14406639	39"	52"	1 3/8" x 6 Spl. Safety Slide Lock	1 3/8" x 6 Spl. Clamp Ball Shear

\*Drivelines are furnished without Cross & Bearing Kit and Implement Yoke. Select kit and yoke as required.

\*\* Please see pages 22-23 for Standard driveline product details.

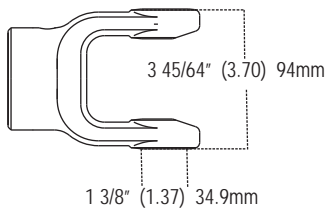

**7N Series**

*Interchanges with Bondioli & Pavesi*

**AB7N**

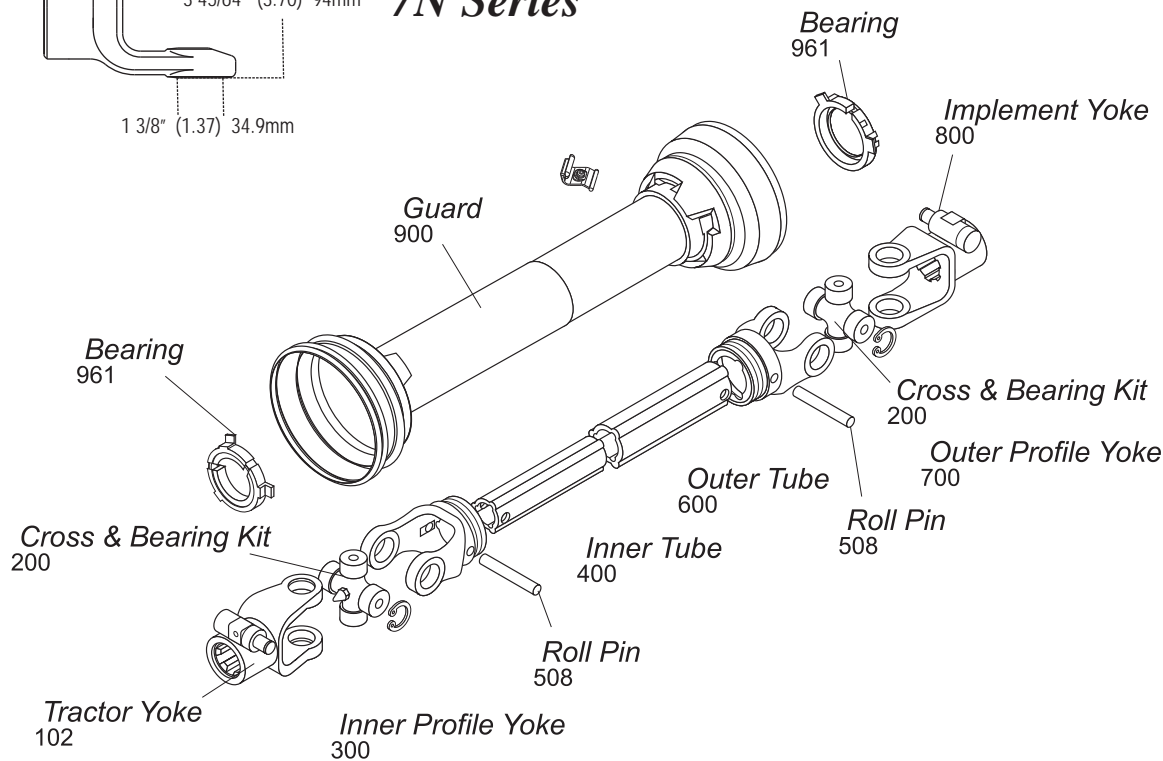

**Tractor Yoke**

**Safety Slide Lock**

Repair Kit —  
\*13004000  
\*\*13004020

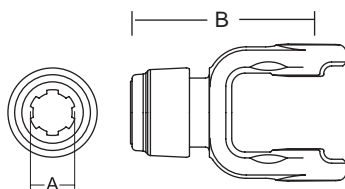

Stock Number	Dim. "A"	Dim. "B"	
	Bore	mm	in.
101-6706*	1 3/8" x 6 Spl.	138.0	5.43"
101-6720**	1 3/4" x 20 Spl.	141.0	5.55"
101-6721*	1 3/8" x 21 Spl.	138.0	5.43"

**Cross & Bearing Kit (R-Kit)**

(Recommended 8 hour grease interval)

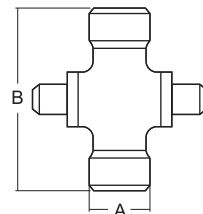

Snap Ring Located In Yoke

Stock Number	Dim. "A"		Dim. "B"	
	mm	in.	mm	in.
200-6794	34.9	1.37"	94.0	3.70"

**Quick Disconnect**

Repair Kit —  
\*13007138  
\*\*13007120

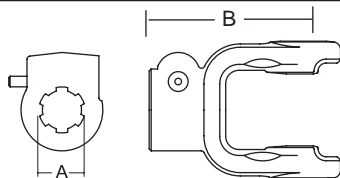

Stock Number	Dim. "A"	Dim. "B"	
	Bore	mm	in.
102-6706*	1 3/8" x 6 Spl.	119.0	4.69"
102-6720**	1 3/4" x 20 Spl.	121.0	4.76"
102-6721*	1 3/8" x 21 Spl.	119.0	4.69"
102-6728**	1 3/4" x 6 Spl.	121.0	4.76"

**Extended Lubrication Cross & Bearing Kit (E-Kit)**

(Recommended 50 hour grease interval)

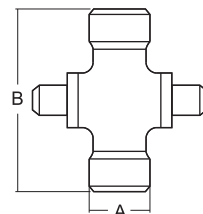

Snap Ring Located In Yoke

Stock Number	Dim. "A"		Dim. "B"	
	mm	in.	mm	in.
201-6794	34.9	1.37"	94.0	3.70"

**Ball Shear**

Repair Kit —  
\*13004000

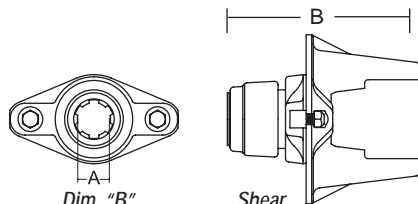

Stock Number	Dim. "A"	Dim. "B"		Shear Bolt
	Bore	mm	in.	
104-6706*	1 3/8" x 6 Spl.	149.0	5.85"	3/8" - 16 Gr. 5
104-6721*	1 3/8" x 21 Spl.	149.0	5.85"	3/8" - 16 Gr. 5

**AB7\***

Stock Number	Dim. "A"		Dim. "B"	
	mm	in.	mm	in.
200-8706	30.2	1.19"	106.5	4.19"
201-8706	30.2	1.19"	106.5	4.19"

\*Old Bondioli & Pavesi 7 Series is interchangeable with Walterscheid 230 Series. Original part identification begins with 23.

### Inner Profile Yoke

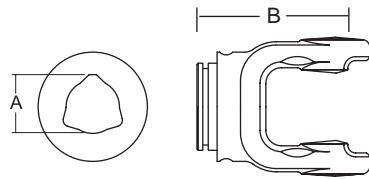

With Bearing Groove  
(Guard must rotate freely on yoke)

Stock Number	Dim. "A"		Dim. "B"	
	mm	in.	mm	in.
300-6745	45.2	1.78"	107.0	4.21"

### Outer Tube

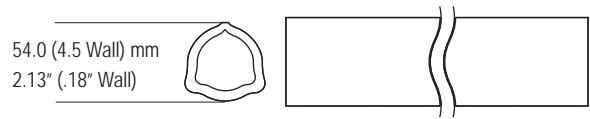

Stock Number	Length	
	m	in.
600-6654	1.5	59.06"
604-6654	1.0	39.37"

### Inner Tube

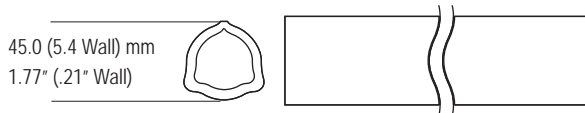

Stock Number	Length	
	m	in.
400-6745	1.5	59.06"
404-6745	1.0	39.37"

### Outer Profile Yoke

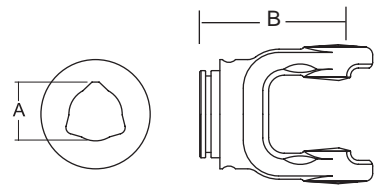

With Bearing Groove  
(Guard must rotate freely on yoke)

Stock Number	Dim. "A"		Dim. "B"	
	mm	in.	mm	in.
700-6754	54.2	2.13"	107.0	4.21"

### Roll Pin

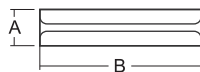

Stock Number	Dim. "A"		Dim. "B"	
	mm	in.	mm	in.
508-1080	10.0	.39"	80.0	3.15"

### Implement Yoke

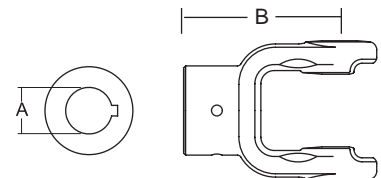

Round Bore  
With Keyway & Set Screw

Stock Number	Dim. "A"		Dim. "B"		Standard keyway	
	mm	in.	mm	in.	mm	in.
800-6722	35.0	1.38"	119.0	4.69"	8.0	.31"
800-6728	44.5	1.75"	119.0	4.69"	9.5	.38"
800-6740	40.0	1.57"	119.0	4.69"	12.7	.50"

## 7N Series (cont'd.)

### Guard

Order Bearings As Required

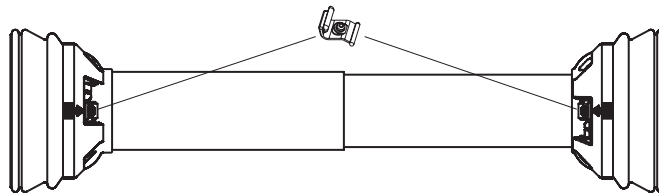

Stock Number	Fits Overall Driveline Length	Bearing Kit (2-per kit)
902-3548	48"	961-3567
902-3560	60"	961-3567

Assembly instructions included with guard bearing kit  
NOTE: Guards must rotate freely on yokes

### Easy Lock™ Replacement Kit

Part Number: 13005000 (4-per Kit)



### Guard Chain Kit

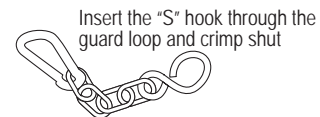

Insert the "S" hook through the guard loop and crimp shut

Part Number: 13006500 (2-per Kit)

### Driveline

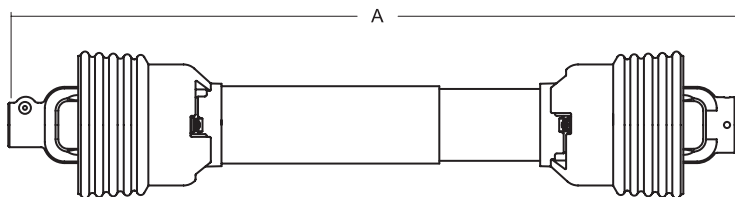

Stock Number	Overall Comp. Length Dim. "A"	Max. Running Length	Tractor Yoke	Implement Yoke
14006748	48"	70"	1 3/8" x 6 Spl. QD	1 3/4" Rd. w/3/8" Keyway
14046748	48"	70"	1 3/8" x 6 Spl. QD	*
14046760	60"	83"	1 3/8" x 6 Spl. QD	*

\*Drivelines are furnished without Cross & Bearing Kit and Implement Yoke. Select kit and yoke as required.

Interchanges with Bondioli & Pavesi

AB8

# 8 Series

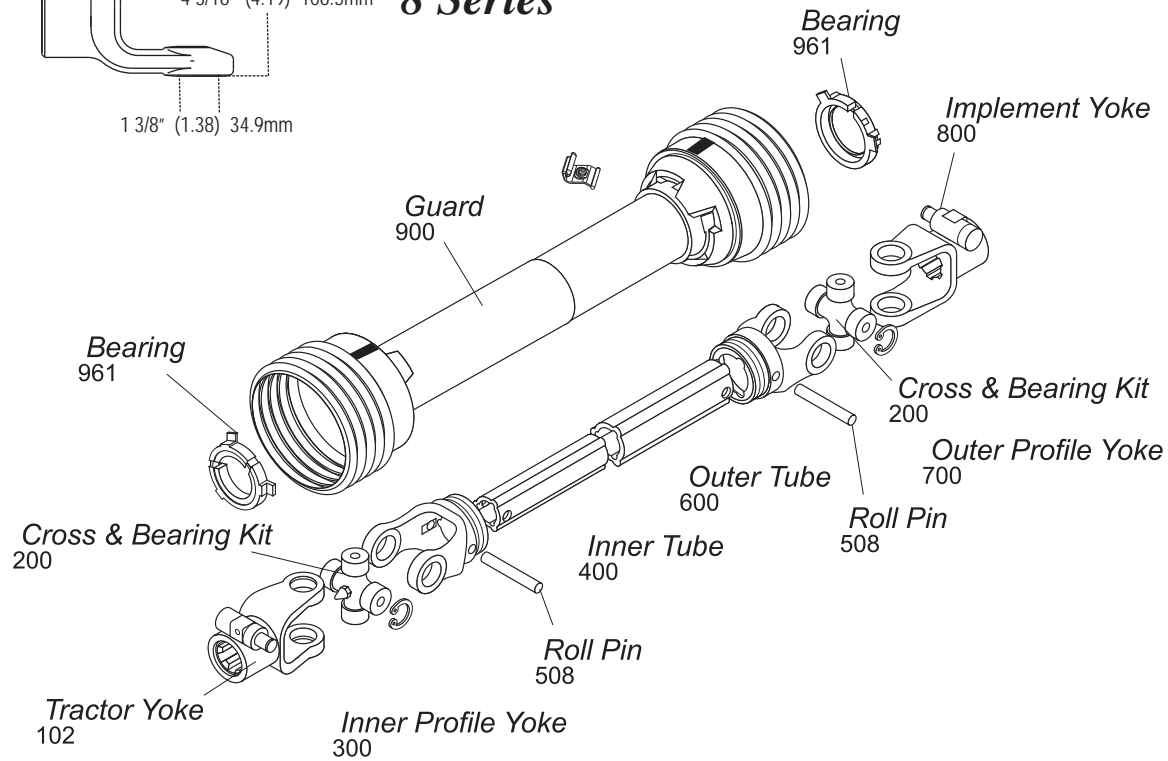
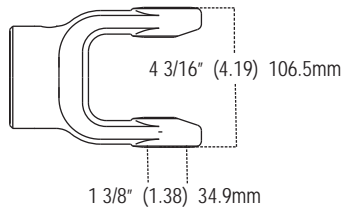

## Tractor Yoke

### Safety Slide Lock

Repair Kit —  
\*13004000  
\*\*13004020

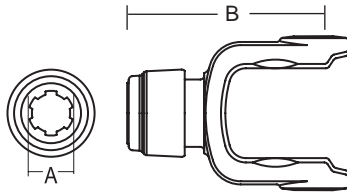

Stock Number	Dim. "A" Bore	Dim. "B" mm	Dim. "B" in.
101-6806*	1 3/8" x 6 Spl.	145.0	5.71"
101-6820**	1 3/4" x 20 Spl.	149.0	5.87"
101-6821*	1 3/8" x 21 Spl.	145.0	5.71"

### Auto-Lok

Repair Kit —  
\*13004000

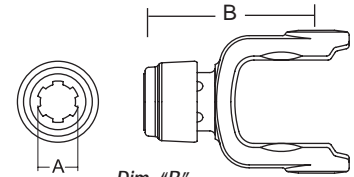

Stock Number	Dim. "A" Bore	Dim. "B" mm	Dim. "B" in.
110-6806*	1 3/8" x 6 Spl.	145.0	5.71"

### Quick Disconnect

Repair Kit —  
\*13007138  
\*\*13007120

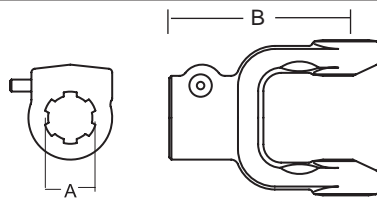

Stock Number	Dim. "A" Bore	Dim. "B" mm	Dim. "B" in.
102-6806*	1 3/8" x 6 Spl.	126.0	4.96"
102-6820**	1 3/4" x 20 Spl.	129.0	5.08"
102-6821*	1 3/8" x 21 Spl.	126.0	4.96"
102-6828**	1 3/4" x 6 Spl.	129.0	5.08"

## Cross & Bearing Kit (R-Kit)

(Recommended 8 hour grease interval)

Snap Ring Located In Yoke

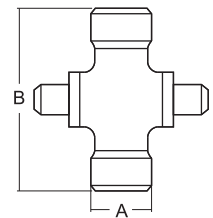

Stock Number	Dim. "A" mm	Dim. "A" in.	Dim. "B" mm	Dim. "B" in.
200-6806	34.9	1.38"	106.5	4.19"

## Extended Lubrication Cross & Bearing Kit (E-Kit)

(Recommended 50 hour grease interval)

Snap Ring Located In Yoke

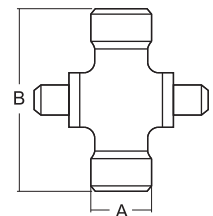

Stock Number	Dim. "A" mm	Dim. "A" in.	Dim. "B" mm	Dim. "B" in.
201-6806	34.9	1.38"	106.5	4.19"

### Ball Shear

Repair Kit —  
\*13004000  
\*\*13004020

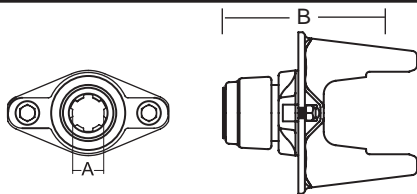

Stock Number	Dim. "A" Bore	Dim. "B" mm	Dim. "B" in.	Shear Bolt
104-6806*	1 3/8" x 6 Spl.	155.0	6.12"	3/8" - 16 Gr. 5
104-6820**	1 3/4" x 20 Spl.	169.0	6.64"	3/8" - 16 Gr. 5
104-6821*	1 3/8" x 21 Spl.	155.0	6.12"	3/8" - 16 Gr. 5

Replacement Shear Bolt Part No. 11-10445

## 8 Series (cont'd.)

### Inner Profile Yoke

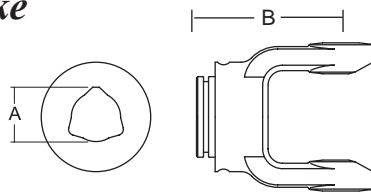

With Bearing Groove  
(Guard must rotate freely on yoke)

Stock Number	Dim. "A"		Dim. "B"	
	mm	in.	mm	in.
300-6845*	45.2	1.78"	120.0	4.72"
300-6854	54.2	2.13"	120.0	4.72"

\*Old Series 8

### Outer Profile Yoke

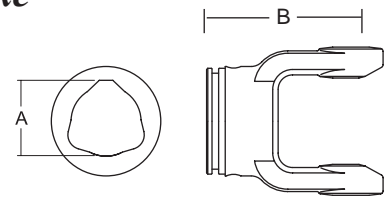

With Bearing Groove  
(Guard must rotate freely on yoke)

Stock Number	Dim. "A"		Dim. "B"	
	mm	in.	mm	in.
700-6863	63.0	2.48"	120.0	4.72"

### Inner Tube

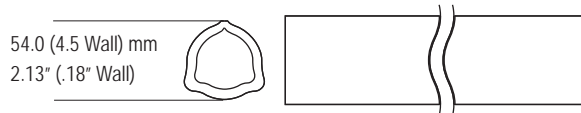

Stock Number	Length	
	m	in.
600-6654	1.5	59.06"
604-6654	1.0	39.37"

### Implement Yoke

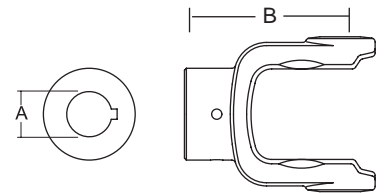

Round Bore  
With Keyway & Set Screw

Stock Number	Dim. "A"		Dim. "B"		Standard keyway	
	mm	in.	mm	in.	mm	in.
800-6822	35.0	1.38"	117.0	4.61"	8.0	.31"
800-6824	38.1	1.50"	120.0	4.72"	9.5	.37"
800-6828	44.5	1.75"	120.0	4.72"	9.5	.37"
800-6832	50.8	2.00"	120.0	4.72"	12.7	.5"

### Roll Pin

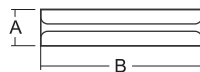

Stock Number	Dim. "A"		Dim. "B"	
	mm	in.	mm	in.
508-0880	8.0	.31"	80.0	3.15"
508-1280	12.0	.47"	80.0	3.15"

Spline Bore  
With Pinhole

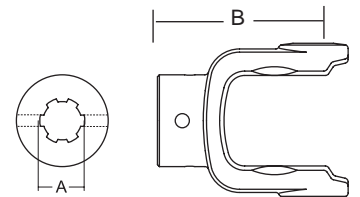

Stock Number	Dim. "A"	Dim. "B"		Pinhole	
		mm	in.	mm	in.
801-6806	1 3/8" x 6 Spl.	117.0	4.61"	7.93	.312"

### Outer Tube

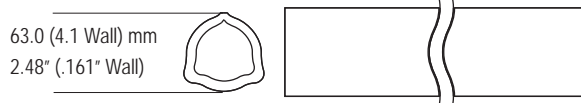

Stock Number	Length	
	m	in.
600-6863	1.5	59.06"
604-6863	1.0	39.37"

Clamp Yoke

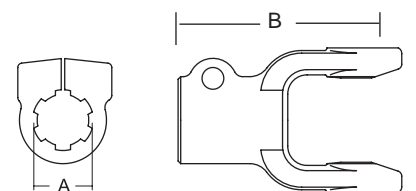

Stock Number	Dim. "A"	Dim. "B"	
		mm	in.
807-6806	1 3/8" x 6 Spl.	124.0	4.88"
807-6820	1 3/4" x 20 Spl.	129.0	5.08"
807-6821	1 3/8" x 21 Spl.	124.0	4.88"

## Guard

Order Bearings As Required

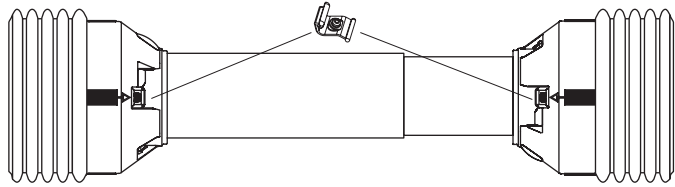

Stock Number	Fits Overall Driveline Length	Bearing Kit (2-per kit)
900-4548	48"	961-4589
900-4560	60"	961-4589

Assembly instructions included with guard bearing kit  
Note: Guards must rotate freely on yokes

## Easy Lock™ Replacement Kit

Part Number: 13005000 (4-per Kit)



## Guard Chain Kit

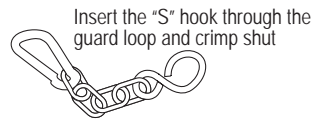

Part Number: 13006500 (2-per Kit)

## Driveline

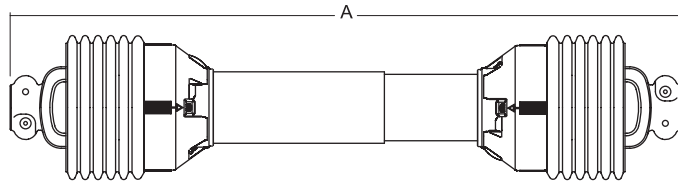

Stock Number	Overall Comp. Length Dim. "A"	Max. Running Length	Tractor Yoke	Implement Yoke
14006828	57"	83"	1 3/8" x 6 Spl. QD	1 3/4" Rd. w/3/8" Keyway
14006846	46"	63"	1 3/8" x 6 Spl. QD	1 3/8" x 6 Spl. QD
14006857	57"	65"	1 3/8" x 6 Spl. QD	1 3/8" x 6 Spl. QD
14046848	48"	70"	1 3/8" x 6 Spl. QD	*
14046860	60"	86"	1 3/8" x 6 Spl. QD	*
14066846	46"	63"	1 3/8" x 21 Spl. QD	1 3/8" x 21 Spl. QD
14406832	32"	40"	1 3/8" x 6 Spl. Safety Slide Lock	1 1/2" Rd. w/3/8" Keyway Shear Bolt Yoke

\*Drivelines are furnished without Cross & Bearing Kit and Implement Yoke. Select kit and yoke as required.



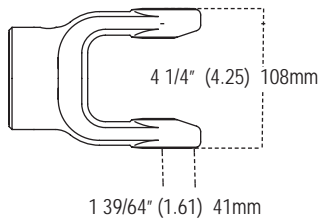

**9 Series**

*Interchanges with Bondioli & Pavesi*

**AB9**

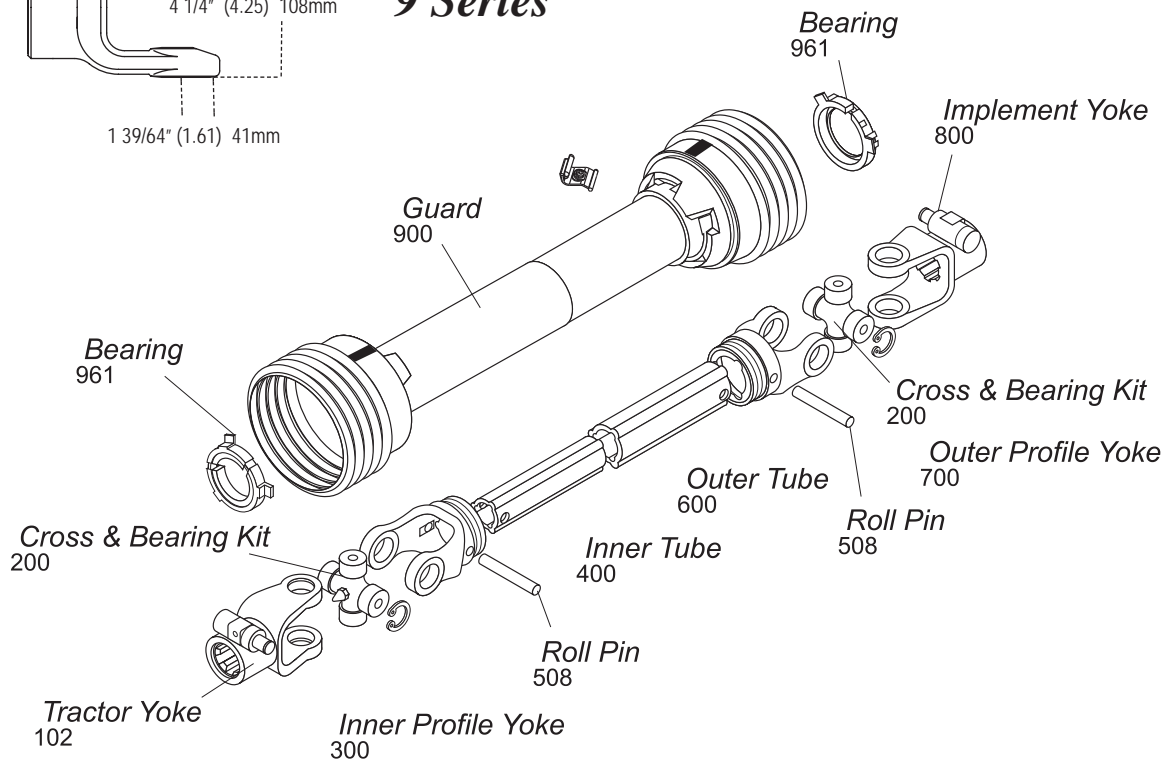

**Tractor Yoke**

**Safety Slide Lock**

Repair Kit —  
\*13004000  
\*\*13004020

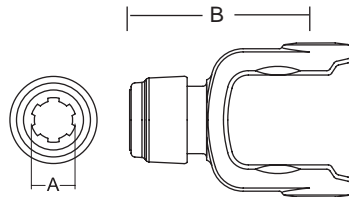

Stock Number	Dim. "A"	Dim. "B"	
	Bore	mm	in.
101-6906*	1 3/8" x 6 Spl.	150.0	5.91"
101-6920**	1 3/4" x 20 Spl.	150.0	5.91"
101-6921*	1 3/8" x 21 Spl.	150.0	5.91"

**Cross & Bearing Kit**

**(R-Kit)**

(Recommended 8 hour grease interval)

Snap Ring Located In Yoke

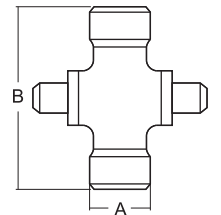

Stock Number	Dim. "A"		Dim. "B"	
	mm	in.	mm	in.
200-6908	41.0	1.61"	108	4.25"

**Quick Disconnect**

Repair Kit —  
\*13007138  
\*\*13007120

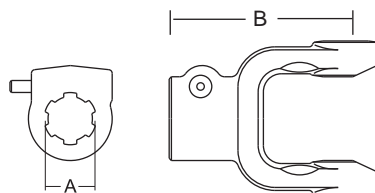

Stock Number	Dim. "A"	Dim. "B"	
	Bore	mm	in.
102-6906*	1 3/8" x 6 Spl.	128.0	5.04"
102-6920**	1 3/4" x 20 Spl.	131.0	5.16"
102-6921*	1 3/8" x 21 Spl.	128.0	5.04"

**Extended Lubrication  
Cross & Bearing Kit**

**(E-Kit)**

(Recommended 50 hour grease interval)

Snap Ring Located In Yoke

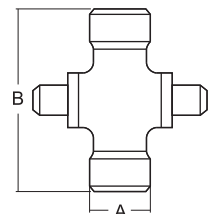

Stock Number	Dim. "A"		Dim. "B"	
	mm	in.	mm	in.
201-6908	41.0	1.61"	108	4.25"

### Inner Profile Yoke

With Bearing Groove  
(Guard must rotate freely on yoke)

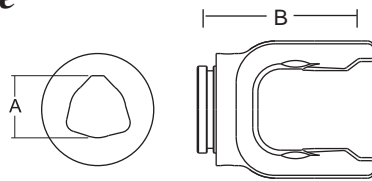

Stock Number	Dim. "A"		Dim. "B"	
	mm	in.	mm	in.
300-6954	54.2	2.13"	123.0	4.84"

### Outer Tube

63.0 (4.1 Wall) mm  
2.48" (.16" Wall)

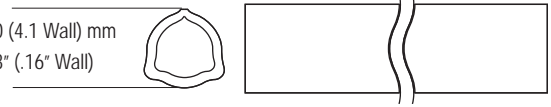

Stock Number	Length	
	m	in.
600-6863	1.5	59.06"
604-6863	1.0	39.37"

### Inner Profile Tube

54.0 (4.9 Wall) mm  
2.13" (.19" Wall)

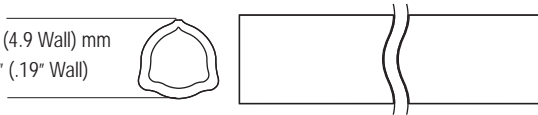

Stock Number	Length	
	m	in.
400-6954	1.5	59.06"
404-6954	1.0	39.37"

### Outer Profile Yoke

With Bearing Groove  
(Guard must rotate freely on yoke)

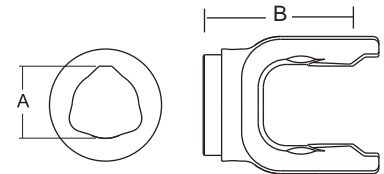

Stock Number	Dim. "A"		Dim. "B"	
	mm	in.	mm	in.
700-6963	63.0	2.48"	123.0	4.84"

### Roll Pin

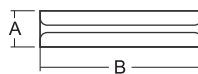

Stock Number	Dim. "A"		Dim. "B"	
	mm	in.	mm	in.
508-1080	10.0	.39"	80.0	3.15"
508-1280	12.0	.47"	80.0	3.15"

### Implement Yoke

Round Bore  
With Keyway & Set Screw

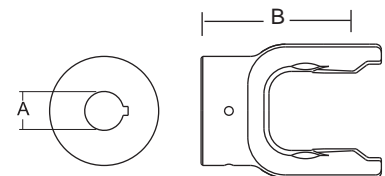

Stock Number	Dim. "A"		Dim. "B"		Standard keyway	
	mm	in.	mm	in.	mm	in.
800-6922	35.0	1.38"	131.0	5.16"	8.0	.31"
800-6924	38.1	1.50"	131.0	5.16"	9.5	.38"

## 9 Series (cont'd.)

### Guard

Order Bearings As Required

Stock

Number	Fits Overall Driveline Length	Bearing Kit (2-per kit)
900-4548	48"	961-4589
900-4560	60"	961-4589

Assembly instructions included with guard bearing kit  
 Note: Guards must rotate freely on yokes

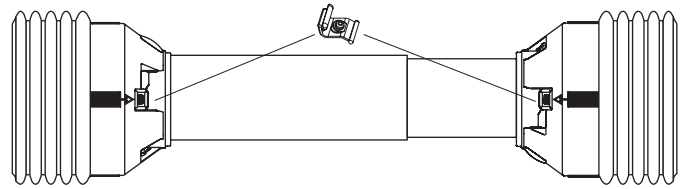

### Easy Lock™ Replacement Kit

Part Number: 13005000 (4-per Kit)



### Guard Chain Kit

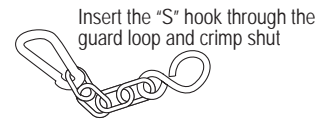

Part Number: 13006500 (2-per Kit)

### Driveline

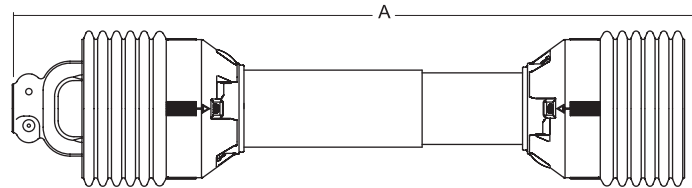

Stock Number	Overall Comp. Length Dim. "A"	Max. Running Length	Tractor Yoke	Implement Yoke
14046948	48"	70"	1 3/8" x 6 Spl. QD	*
14046960	60"	86"	1 3/8" x 6 Spl. QD	*

\*Drivelines are furnished without Cross & Bearing Kit and Implement Yoke. Select kit and yoke as required.

*Interchanges with Walterscheid*

**2100/100Series**

**AW10**

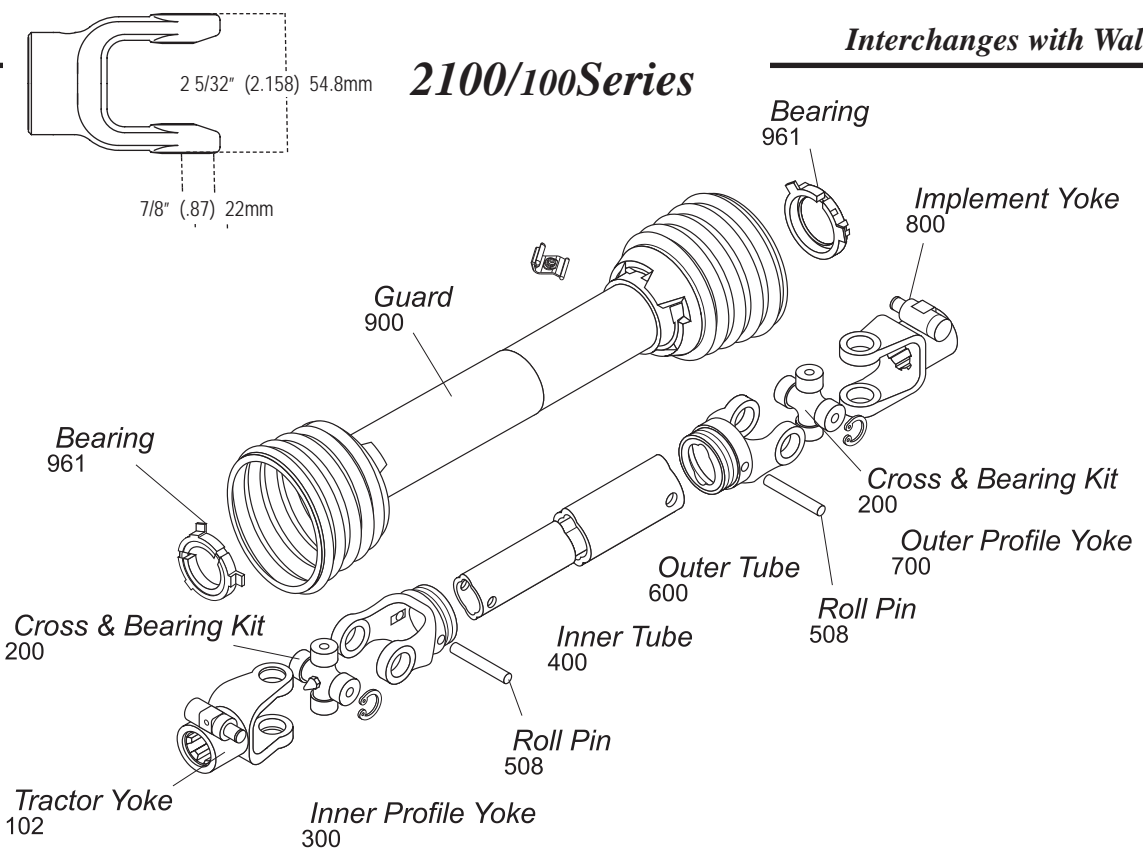

**Tractor Yoke**

**Safety Slide Lock**  
Repair Kit —  
\*19-15094

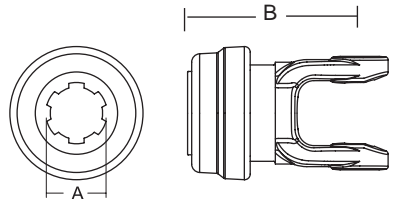

Stock Number	Dim. "A"	Dim. "B"	
		mm	in.
101-7106*	1 3/8" x 6 Spl.	98.0	3.86"
101-7121*	1 3/8" x 21 Spl.	98.0	3.86"

**Cross & Bearing Kit (R-Kit)**

(Recommended 8 hour grease interval)

Snap Ring Located In Yoke

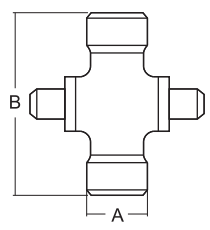

Stock Number	Dim. "A"		Dim. "B"	
	mm	in.	mm	in.
200-7155	22.0	.87"	54.8	2.158"

**Quick Disconnect**  
Repair Kit —  
\*13007138

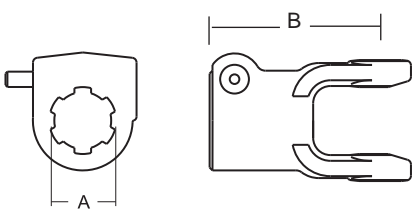

Stock Number	Dim. "A"	Dim. "B"	
		mm	in.
102-7106*	1 3/8" x 6 Spl.	89.0	3.5"
102-7121*	1 3/8" x 21 Spl.	89.0	3.5"

**Extended Lubrication Cross & Bearing Kit (E-Kit)**

(Recommended 50 hour grease interval)

Snap Ring Located In Yoke

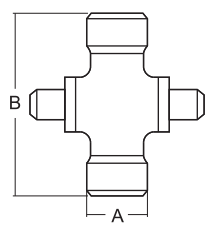

Stock Number	Dim. "A"		Dim. "B"	
	mm	in.	mm	in.
201-7155	22.0	.87"	54.8	2.158"

**Inner Profile Yoke**

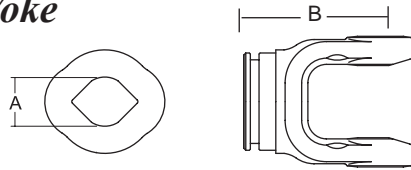

With Bearing Groove

(Guard must rotate freely on yoke)

Stock Number	Dim. "A"		Dim. "B"	
	mm	in.	mm	in.
300-7123	23.8	.94"	66.0	2.6"

**Outer Profile Yoke**

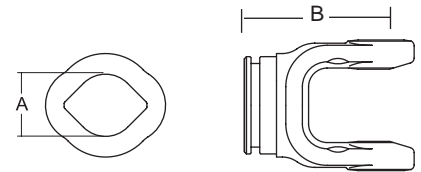

With Bearing Groove

(Guard must rotate freely on yoke)

Stock Number	Dim. "A"		Dim. "B"	
	mm	in.	mm	in.
700-7130	30	1.18"	66.0	2.6"

**Inner Tube**

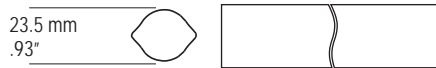

Stock Number	Length	
	m	in.
400-7123	1.5	59.06"
404-7123	1.0	39.37"

**Roll Pin**

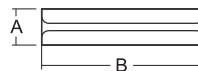

Stock Number	Dim. "A"		Dim. "B"	
	mm	in.	mm	in.
508-0850	8.0	.31"	50.0	1.97"

**Outer Tube**



Stock Number	Length	
	m	in.
600-7130	1.5	59.06"
604-7130	1.0	39.37"

**Guard**

Order Bearings As Required

Stock Number	Fits Overall Driveline Length	Bearing Kit (2-per kit)
		Part Number
900-2548	48"	961-5005
900-2560	60"	961-5005

Assembly instructions included with guard bearing kit  
Note: Guards must rotate freely on yokes

**Implement Yoke**

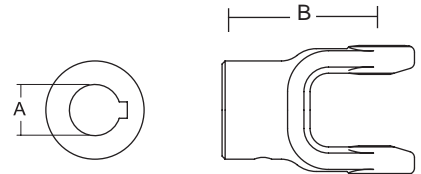

Round Bore

With Keyway & Set Screw

Stock Number	Dim. "A"		Dim. "B"		Standard keyway	
	mm	in.	mm	in.	mm	in.
800-7125	25.0	.98"	78.0	3.07"	8.0	.31"
800-7130	30.0	1.18"	78.0	3.07"	8.0	.31"

Shear Pin

With Pin Hole

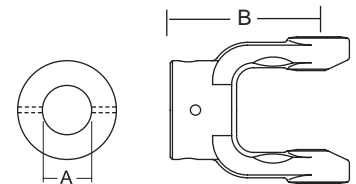

Stock Number	Dim. "A"		Dim. "B"		Pinhole	
	mm	in.	mm	in.	mm	in.
802-7110	31.8	1.25"	78.0	3.07"	6.35	.25"
802-7130	30.0	1.18"	78.0	3.07"	10.00	.394"

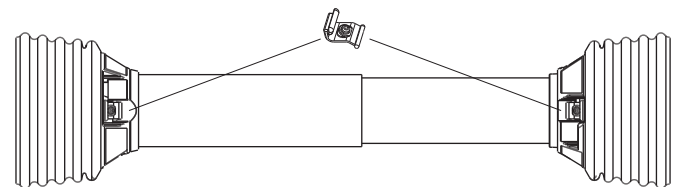

**Easy Lock™ Replacement Kit**

Part Number: 13005000 (4-per Kit)



**Guard Chain Kit**

Part Number: 13006500 (2-per Kit)

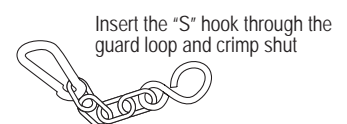

*Interchanges with Walterscheid*

**2200/200Series**

**AW20**

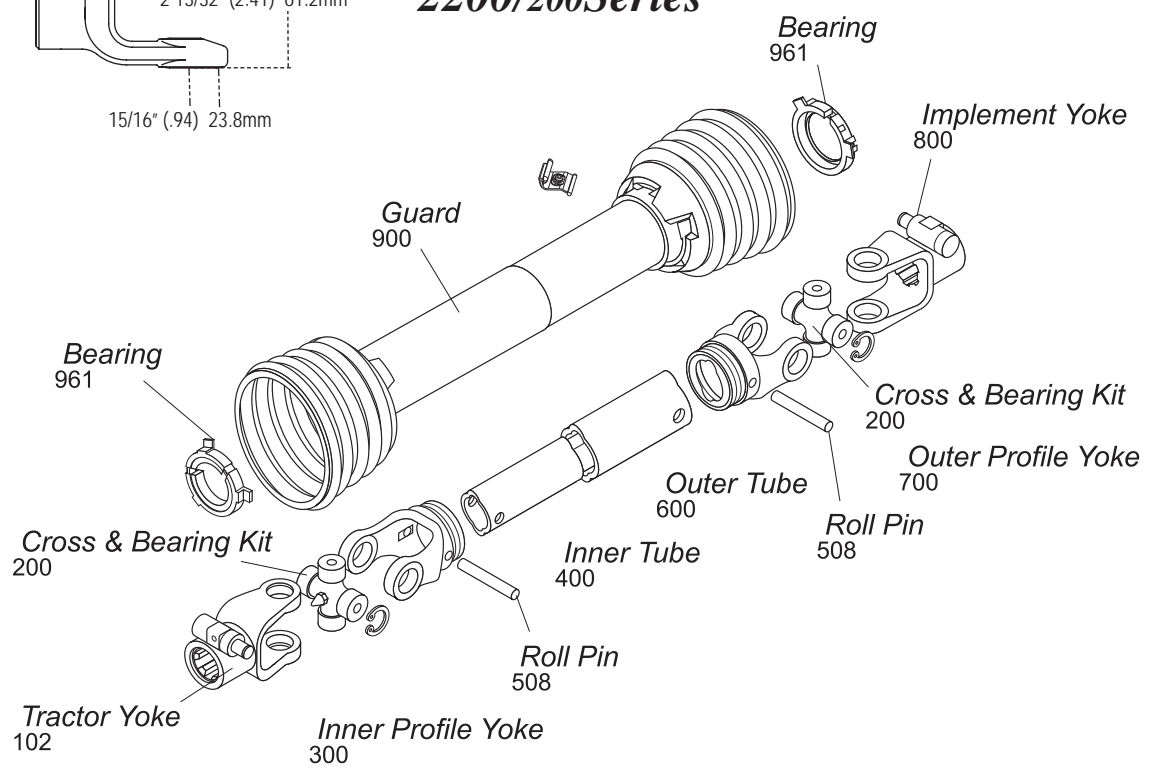
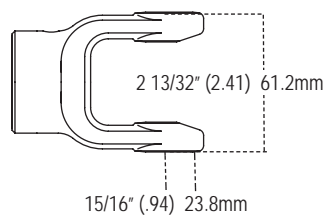

Cross & Bearing Kit and Outboard Yokes interchange with Bondioli 2 Series

**Tractor Yoke**

**Safety Slide Lock**

Repair Kit —  
\*19-15094

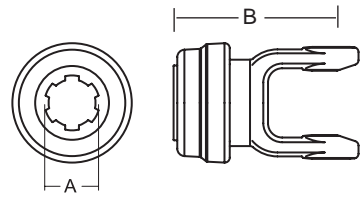

Stock Number	Dim. "A"	Dim. "B"	
		mm	in.
101-8206*	1 3/8" x 6 Spl.	106.0	4.17"
101-8221*	1 3/8" x 21 Spl.	105.0	4.13"

**Cross & Bearing Kit (R-Kit)**

(Recommended 8 hour grease interval)

Snap Ring Located In Yoke

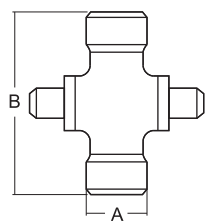

Stock Number	Dim. "A"		Dim. "B"	
	mm	in.	mm	in.
200-8261	23.8	.94"	61.2	2.41"

**Quick Disconnect**

Repair Kit —  
\*13007138

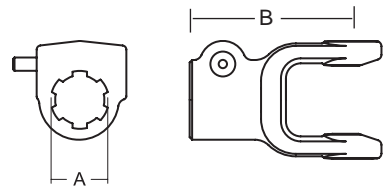

Stock Number	Dim. "A"	Dim. "B"	
		mm	in.
102-8206*	1 3/8" x 6 Spl.	98.0	3.86"
102-8218*	1 1/8" x 6 Spl.	94.0	3.70"
102-8221*	1 3/8" x 21 Spl.	98.0	3.86"

**Extended Lubrication Cross & Bearing Kit (E-Kit)**

(Recommended 50 hour grease interval)

Snap Ring Located In Yoke

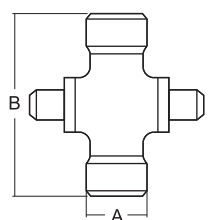

Stock Number	Dim. "A"		Dim. "B"	
	mm	in.	mm	in.
201-8261	23.8	.94	61.2	2.41"

**Inner Profile Yoke**

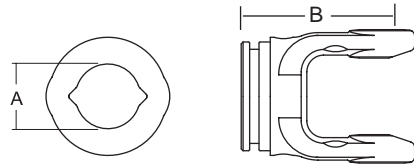

With Bearing Groove  
(Guard must rotate freely on yoke)

Stock Number	Dim. "A"		Dim. "B"	
	mm	in.	mm	in.
300-7234	34.5	1.36"	75.0	2.95"

**Outer Profile Yoke**

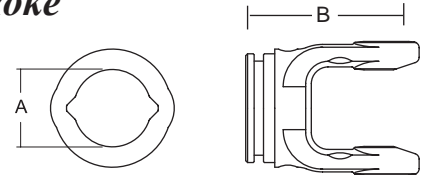

With Bearing Groove  
(Guard must rotate freely on yoke)

Stock Number	Dim. "A"		Dim. "B"	
	mm	in.	mm	in.
700-7241	41.3	1.63	75.0	2.95"

**Inner Tube**

34.5 (4.0 Wall) mm  
1.36" (.16" Wall)



Stock Number	Length	
	m	in.
400-7234	1.5	59.06"
404-7234	1.0	39.37"

**Roll Pin**

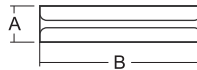

Stock Number	Dim. "A"		Dim. "B"	
	mm	in.	mm	in.
508-1060	10.0	.39"	60.0	2.36"

**Outer Tube**

41.0 (2.9 Wall) mm  
1.61" (.114" Wall)



Stock Number	Length	
	m	in.
600-7241	1.5	59.06"
604-7241	1.0	39.37"

**Guard**

Order Bearings As Required

Stock Number	Fits Overall Driveline Length	Bearing Kit (2-per kit)
900-2548	48"	961-0251
900-2560	60"	961-0251

Assembly instructions included with guard bearing kit  
Note: Guards must rotate freely on yokes

**Implement Yoke**

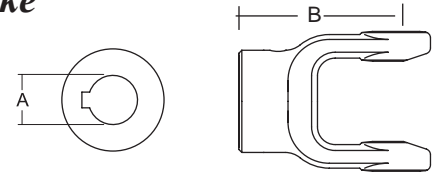

Round Bore

With Keyway & Set Screw

Stock Number	Dim. "A"		Dim. "B"		Standard keyway	
	mm	in.	mm	in.	mm	in.
800-8225	25.0	.98"	80.0	3.15"	8.0	.31"
800-8208	25.4	1.0"	80.0	3.15"	6.4	.25"
800-8230	30.0	1.18"	80.0	3.15"	8.0	.31"
800-8210	31.8	1.25"	80.0	3.15"	6.4	.25"
800-8211	34.9	1.38"	80.0	3.15"	8.0	.31"
800-8218	28.6	1.13"	80.0	3.15"	6.4	.25"
800-8220	31.8	1.25"	80.0	3.15"	8.0	.31"

Shear Pin

With Pin Hole

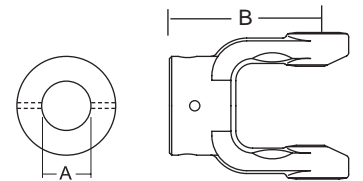

Stock Number	Dim. "A"		Dim. "B"		Pinhole	
	mm	in.	mm	in.	mm	in.
802-8220	31.8	1.25"	80.0	3.15"	6.35	.25"
802-8222	35.0	1.38"	92.0	3.62"	12.9	.50"
802-8225	25.0	.98"	80.0	3.15"	8.0	.315"
802-8230	30.0	1.18"	80.0	3.15"	10.0	.394"

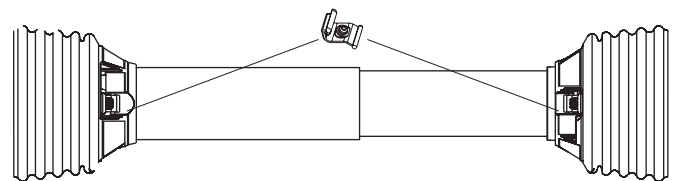

**Easy Lock™ Replacement Kit**

Part Number: 13005000 (4-per Kit)



**Guard Chain Kit**

Part Number: 13006500 (2-per Kit)

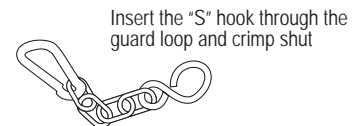

Insert the "S" hook through the guard loop and crimp shut

# I Series

AW11

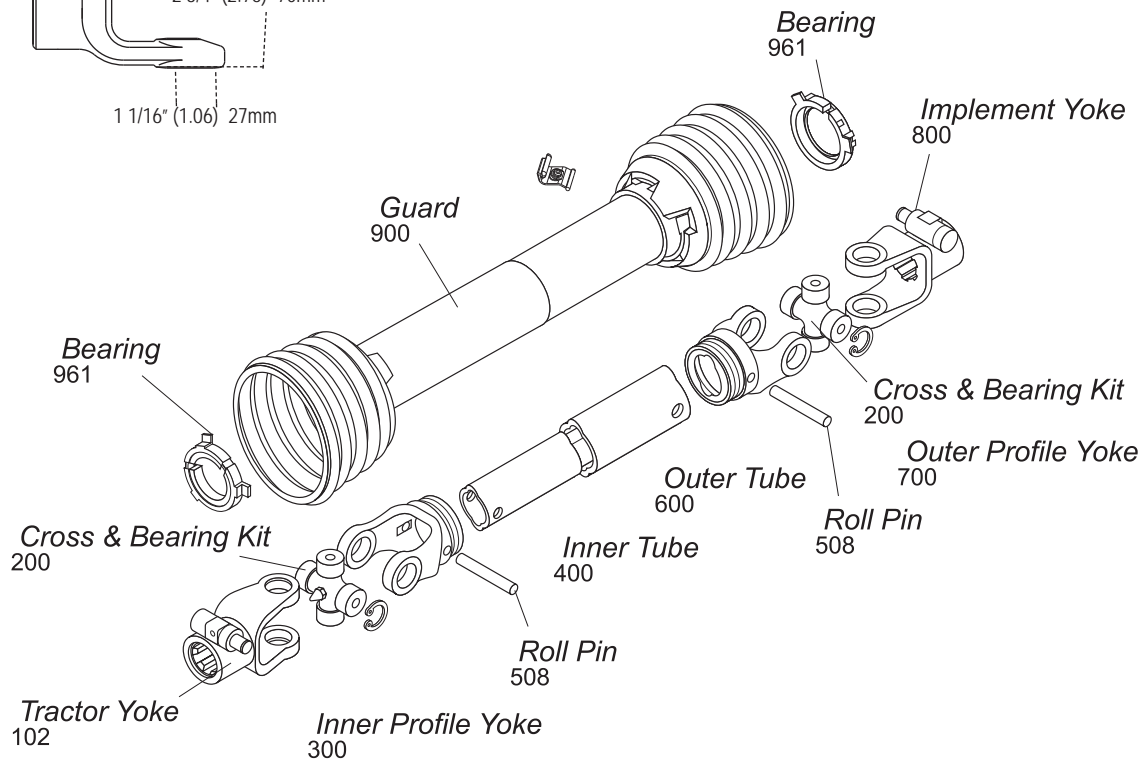
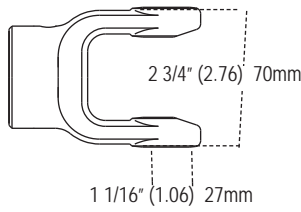

Cross & Bearing Kit and Outboard Yokes interchange with Bondioli 3 Series

## Tractor Yoke

Safety Slide Lock  
Repair Kit — \*19-15094

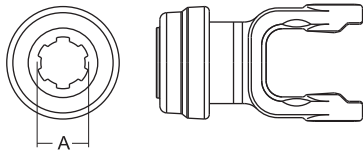

Stock Number	Dim. "A" Bore	Dim. "B"	
		mm	in.
101-8306*	1 3/8" x 6 Spl.	120.0	4.72"
101-8321*	1 3/8" x 21 Spl.	120.0	4.72"

## Cross & Bearing Kit

(R-Kit)  
(Recommended 8 hr. grease interval)

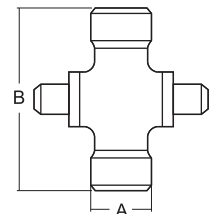

Snap Ring Located In Yoke

Stock Number	Dim. "A"		Dim. "B"	
	mm	in.	mm	in.
200-8370	27.0	1.06"	70.0	2.76"

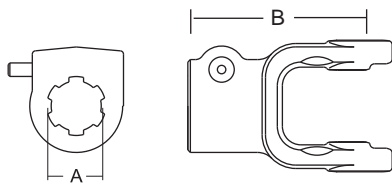

Quick Disconnect  
Repair Kit — \*13007138

Stock Number	Dim. "A" Bore	Dim. "B"	
		mm	in.
102-8306*	1 3/8" x 6 Spl.	102.0	4.02"
102-8321*	1 3/8" x 21 Spl.	102.0	4.02"

## Extended Lubrication Cross & Bearing Kit

(E-Kit)  
(Recommended 50 hr. grease interval)

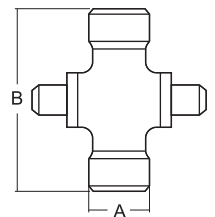

Snap Ring Located In Yoke

Stock Number	Dim. "A"		Dim. "B"	
	mm	in.	mm	in.
201-8370	27.0	1.06"	70.0	2.76"



# I Series (cont'd.)

## Inner Profile Yoke

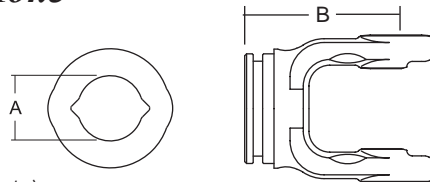

With Bearing Groove  
(Guard must rotate freely on yoke)

Stock Number	Dim. "A"		Dim. "B"	
	mm	in.	mm	in.
300-7334	34.5	1.36"	80.0	3.15"

## Outer Profile Yoke

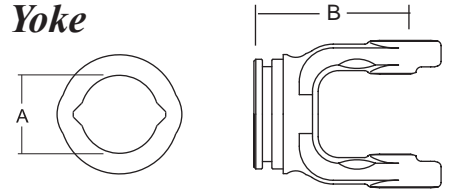

With Bearing Groove  
(Guard must rotate freely on yoke)

Stock Number	Dim. "A"		Dim. "B"	
	mm	in.	mm	in.
700-7341	41.3	1.63"	80.0	3.15"

## Inner Tube

34.5 (4.0 Wall) mm  
1.36" (.16" Wall)



Stock Number	Length	
	m	in.
400-7234	1.5	59.06"
404-7234	1.0	39.37"

## Roll Pin

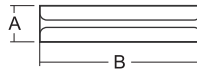

Stock Number	Dim. "A"		Dim. "B"	
	mm	in.	mm	in.
508-1065	10.0	.39"	65.0	2.56"

## Outer Tube

41.0 (2.9 Wall) mm  
1.61" (.114" Wall)



Stock Number	Length	
	m	in.
600-7241	1.5	59.06"
604-7241	1.0	39.37"

## Easy Lock™ Replacement Kit

Part Number: 13005000 (4-per Kit)

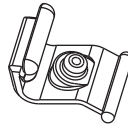

## Guard

Order Bearings As Required

Stock Number	Overall Driveline Length	Bearing Kit (2-per kit)
900-2548	48"	961-0251
900-2560	60"	961-0251

Assembly instructions included with guard bearing kit  
NOTE: Guards must rotate freely on yokes

## Implement Yoke

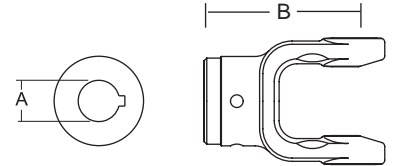

Round Bore  
With Keyway & Set Screw

Stock Number	Dim. "A" Bore		Dim. "B"		Standard Keyway	
	mm	in.	mm	in.	mm	in.
800-8325	25.0	0.98"	92.0	3.62"	8.0	.31"
800-8330	30.0	1.18"	92.0	3.62"	8.0	.31"
800-8310	31.8	1.25"	92.0	3.62"	6.4	.25"
800-8311	34.9	1.37"	92.0	3.62"	8.0	.31"

Shear Pin  
With Pin Hole

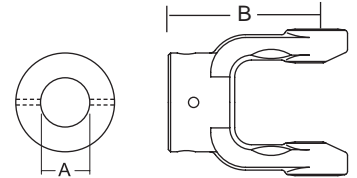

Stock Number	Dim. "A" Bore		Dim. "B"		Standard Keyway	
	mm	in.	mm	in.	mm	in.
802-8310	31.8	1.25"	92.0	3.62"	6.35	.25"
802-8325	31.8	0.98"	92.0	3.62"	8.00	.315"
802-8330	30.0	1.18"	92.0	3.62"	10.00	.394"
802-8335	35.0	1.38"	92.0	3.62"	12.90	.50"

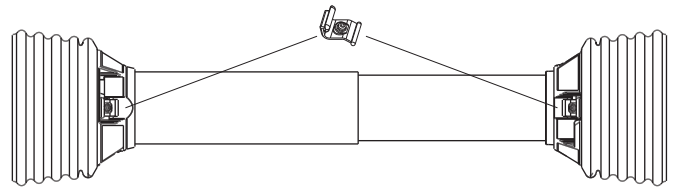

## Guard Chain Kit

Part Number: 13006500 (2-per Kit)

Insert the "S" hook through the guard loop and crimp shut



# 2300/210 Series

AW21

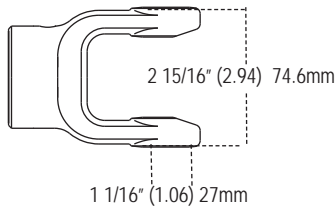

1 1/16" (1.06) 27mm

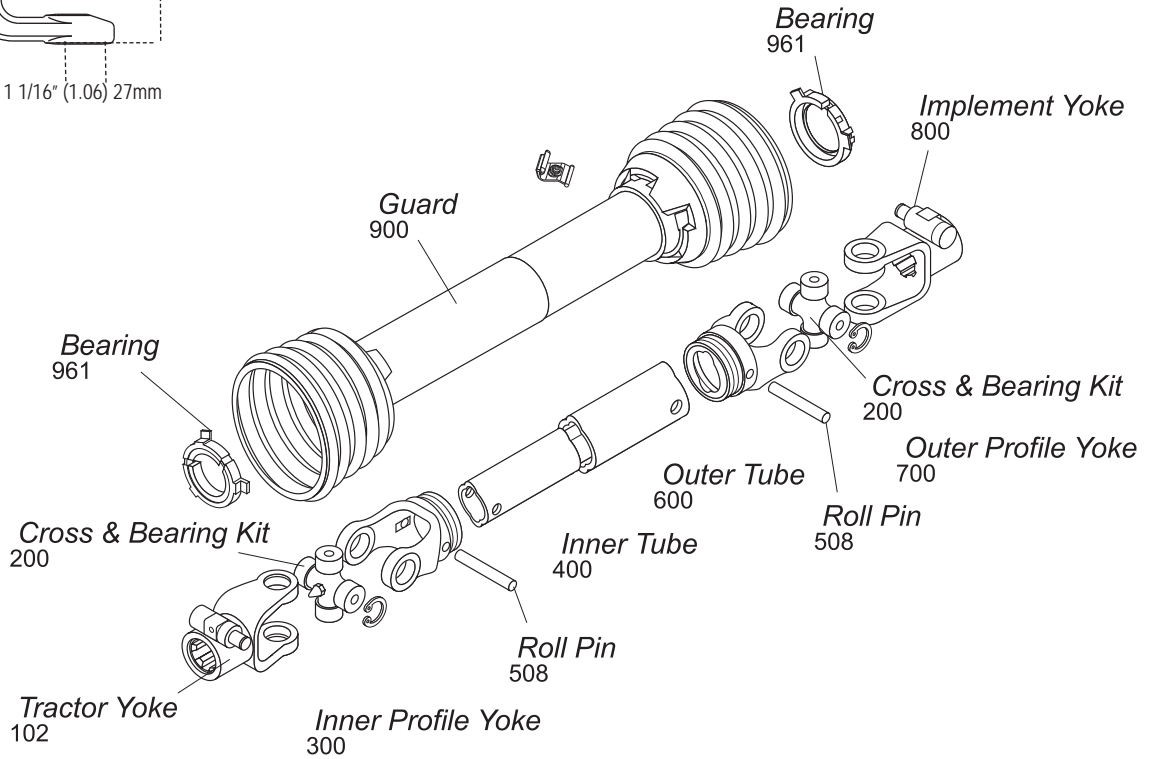

METRIC DRIVE LINES  
& COMPONENTS

Cross & Bearing Kit and Outboard Yokes interchange with Bondioli 4 Series

## Tractor Yoke

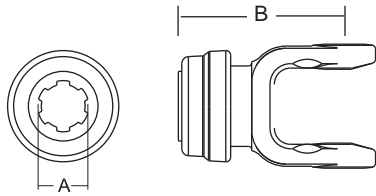

## Safety Slide Lock

Repair Kit — \*19-15094

Stock Number	Dim. "A" Bore	Dim. "B"	
		mm	in.
101-8406*	1 3/8" x 6 Spl.	113.0	4.45"
101-8421*	1 3/8" x 21 Spl.	113.0	4.45"

## Ball Shear Repair Kit

— \*13004000  
\*\*13004020

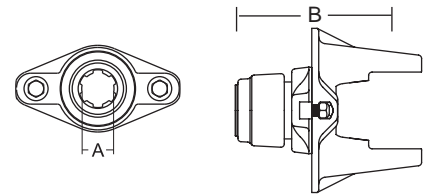

Stock Number	Dim. "A" Bore	Dim. "B"		Shearbolt
		mm	in.	
104-8406*	1 3/8" x 6 Spl.	141.0	5.54"	3/8" - 16 Gr. 5
104-8420**	1 3/4" x 20 Spl.	154.0	6.06"	3/8" - 16 Gr. 5
104-8421*	1 3/8" x 21 Spl.	141.0	5.54"	3/8" - 16 Gr. 5

Replacement Shear Bolt Part No. 11-10445

## Quick Disconnect

Repair Kit — \*13007138

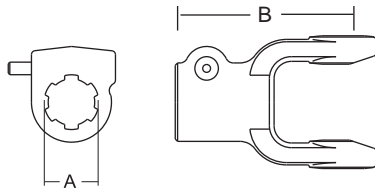

Stock Number	Dim. "A" Bore	Dim. "B"	
		mm	in.
102-8406*	1 3/8" x 6 Spl.	107.0	4.21"
102-8418*	1 1/8" Hex	107.0	4.21"
102-8421*	1 3/8" x 21 Spl.	107.0	4.21"

## Cross & Bearing Kit (R-Kit)

(Recommended 8 hr. grease interval)

Snap Ring Located In Yoke

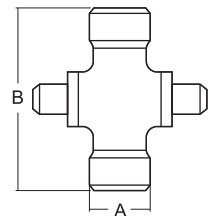

Stock Number	Dim. "A"		Dim. "B"	
	mm	in.	mm	in.
200-8474	27.0	1.06"	74.6	2.94"

## Extended Lubrication Cross & Bearing Kit (E-Kit)

(Recommended 50 hr. grease interval)

Snap Ring Located In Yoke

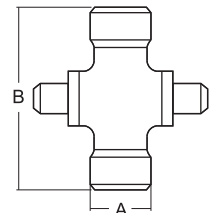

Stock Number	Dim. "A"		Dim. "B"	
	mm	in.	mm	in.
201-8474	27.0	1.06"	74.6	2.94"

## 2300/210 Series (cont'd.)

### Inner Profile Yoke

With Bearing Groove  
(Guard must rotate freely on yoke)

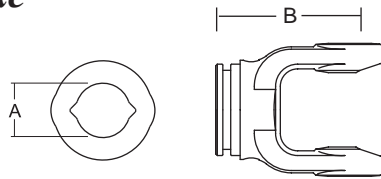

Stock Number	Dim. "A" Bore		Dim. "B"	
	mm	in.	mm	in.
300-7434	34.5	1.36"	85.0	3.35"
300-7439*	39.5	1.56"	85.0	3.35"

\*Uses 902-3548 Guard & 961-3525 Bearing Kit

### Outer Profile Yoke

With Bearing Groove  
(Guard must rotate freely on yoke)

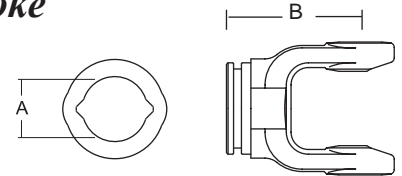

Stock Number	Dim. "A" Bore		Dim. "B"	
	mm	in.	mm	in.
700-7441	41.3	1.63"	85.0	3.35"
701-7448*	48.0	1.89"	90.0	3.54"

\*Uses 902-3548 Guard & 961-3525 Bearing Kit

### Inner Tube

34.5 (4.0 Wall) mm  
1.36" (.16" Wall)



Stock Number	Length	
	m	in.
400-7234	1.5	59.06"
404-7234	1.0	39.37"

### Implement Yoke

#### Round Bore

With Keyway & Set Screw

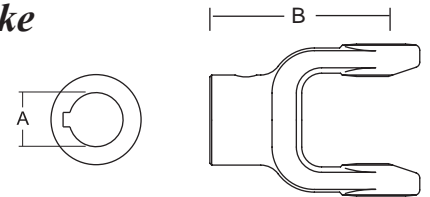

Stock Number	Dim. "A" Bore		Dim. "B"		Standard Keyway	
	mm	in.	mm	in.	mm	in.
800-8430	30.0	1.18"	95.0	3.74"	8.0	.31"
800-8410	31.8	1.25"	95.0	3.74"	6.4	.25"
800-8411	34.9	1.38"	95.0	3.74"	8.0	.31"
800-8424	38.1	1.50"	95.0	3.74"	9.5	.38"
800-8435	35.0	1.38"	95.0	3.74"	10.0	.39"

### Roll Pin

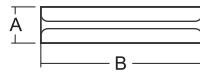

Stock Number	Dim. "A"		Dim. "B"	
	mm	in.	mm	in.
508-1065	10.0	.39"	65.0	2.56"

### Outer Tube

41.0 (2.9 Wall) mm  
1.61" (.114" Wall)



Stock Number	Length	
	m	in.
600-7241	1.5	59.06"
604-7241	1.0	39.37"

#### Shear Pin

With Pin Hole

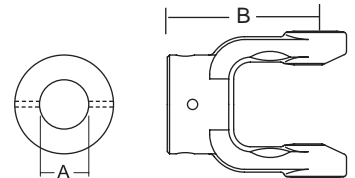

Stock Number	Dim. "A" Bore		Dim. "B"		Pinhole	
	mm	in.	mm	in.	mm	in.
802-8420	31.8	1.25"	95.0	3.74"	6.35	.25"
802-8430	30.0	1.18"	95.0	3.74"	10.0	.39"
802-8435	35.0	1.38"	95.0	3.74"	12.90	.50"

## Guard

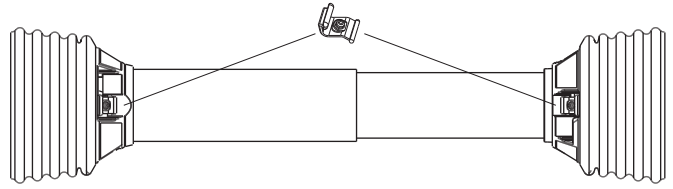

Order Bearings As Required

Stock Number	Overall Driveline Length	Bearing Kit (2-per kit)
900-2548	48"	961-0251
900-2560	60"	961-0251

Assembly instructions included with guard bearing kit  
NOTE: Guards must rotate freely on yokes

## Guard Chain Kit

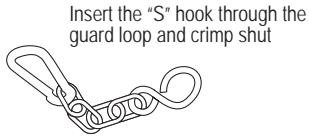

Insert the "S" hook through the guard loop and crimp shut

Part Number: 13006500 (2-per Kit)

## Easy Lock™ Replacement Kit

Part Number: 13005000 (4-per Kit)



**220/720 Series**

**AW22**

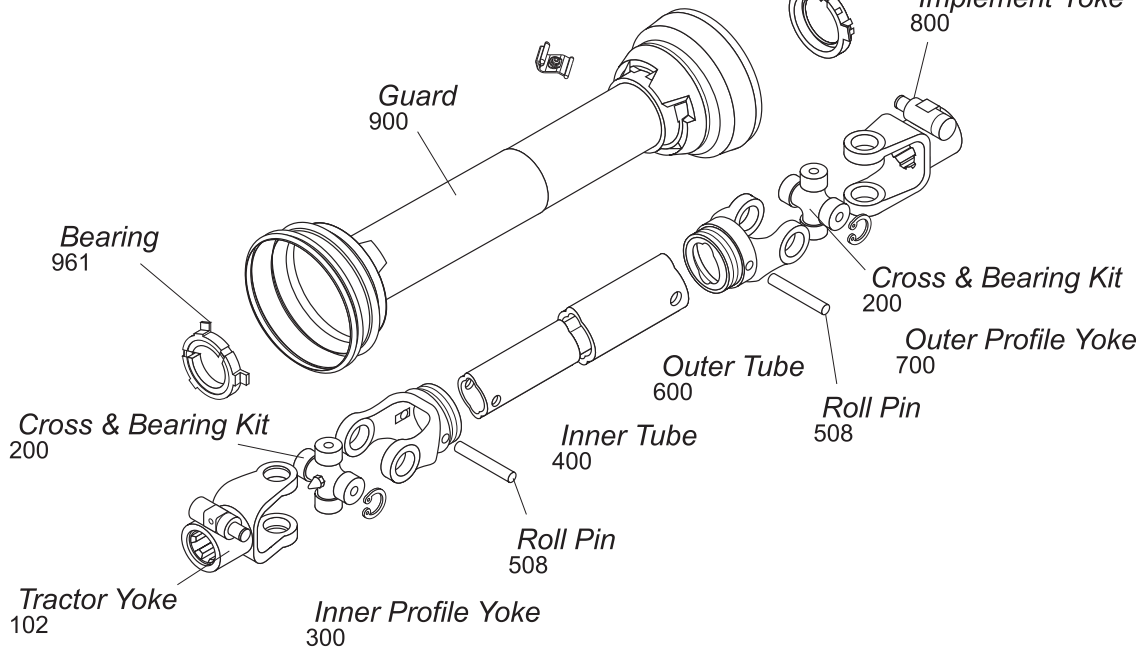
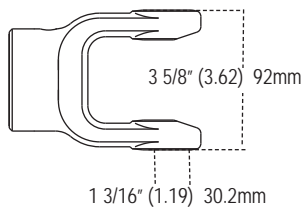

Cross & Bearing Kit and Outboard Yokes interchange with Bondioli 6 Series

**Tractor Yoke**

**Safety Slide Lock**  
Repair Kit —  
\*13004000  
\*\*13004020

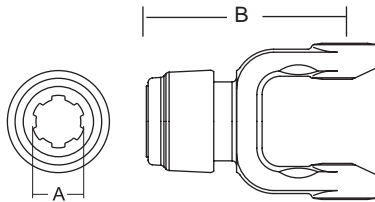

Stock Number	Dim. "A" Bore	Dim. "B"	
		mm	in.
101-8606*	1 3/8" x 6 Spl.	132.0	5.20"
101-8620**	1 3/4" x 20 Spl.	135.0	5.32"
101-8621*	1 3/8" x 21 Spl.	132.0	5.20"

**Ball Shear**  
Repair Kit —  
\*13004000  
\*\*13004020

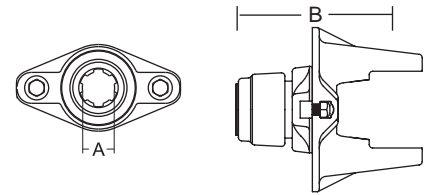

Stock Number	Dim. "A" Bore	Dim. "B"		Shear Bolt
		mm	in.	
104-8606*	1 3/8" x 6 Spl.	149.0	5.85"	3/8" - 16 Gr. 5
104-8620**	1 3/4" x 20 Spl.	162.0	6.37"	3/8" - 16 Gr. 5
104-8621*	1 3/8" x 21 Spl.	149.0	5.85"	3/8" - 16 Gr. 5

**Replacement Shear Bolt Part No. 11-10445**

**Cross & Bearing Kit**

**(R-Kit)**  
(Recommended 8 hr. grease interval)

Snap Ring Located In Yoke

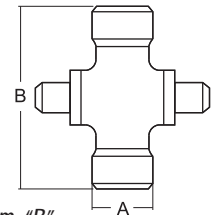

Stock Number	Dim. "A"		Dim. "B"	
	mm	in.	mm	in.
200-8692	30.2	1.19"	92.0	3.62"

**Quick Disconnect**

Repair Kit —  
\*13007138  
\*\*13007120

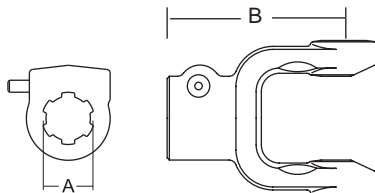

Stock Number	Dim. "A" Bore	Dim. "B"	
		mm	in.
102-8606*	1 3/8" x 6 Spl.	118.0	4.65"
102-8618*	1 1/8" Hex	117.0	4.61"
102-8620**	1 3/4" x 20 Spl.	120.0	4.72"
102-8621*	1 3/8" x 21 Spl.	118.0	4.65"

**Extended Lubrication**

**Cross & Bearing Kit**

**(E-Kit)**  
(Recommended 50 hr. grease interval)

Snap Ring Located In Yoke

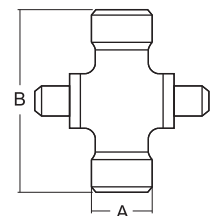

Stock Number	Dim. "A"		Dim. "B"	
	mm	in.	mm	in.
201-8692	30.2	1.19"	92.0	3.62"

### Inner Profile Yoke

With Bearing Groove  
(Guard must rotate freely on yoke)

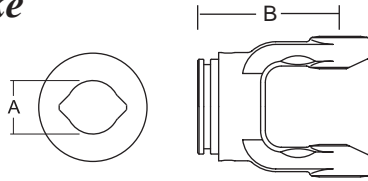

Stock Number	Dim. "A" Bore		Dim. "B"	
	mm	in.	mm	in.
300-7539	39.5	1.56"	105.0	4.13"

### Outer Profile Yoke

With Bearing Groove  
(Guard must rotate freely on yoke)

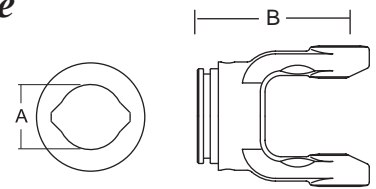

Stock Number	Dim. "A" Bore		Dim. "B"	
	mm	in.	mm	in.
700-7548	48.0	1.89"	105.0	4.13"

### Inner Tube

39.5 (4.5 Wall) mm  
1.56" (.18" Wall)



Stock Number	Length	
	m	in.
400-7539	1.5	59.06"
404-7539	1.0	39.37"

### Implement Yoke

Round Bore  
With Keyway & Set Screw

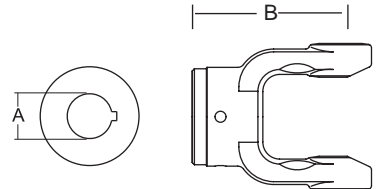

Stock Number	Dim. "A" Bore		Dim. "B"		Standard Keyway	
	mm	in.	mm	in.	mm	in.
800-8610	31.8	1.25"	105.0	4.13"	6.4	.25"
800-8611	34.9	1.38"	105.0	4.13"	8.0	.31"
800-8624	38.1	1.50"	105.0	4.13"	9.5	.38"
800-8628	44.5	1.75"	108.0	4.25"	9.5	.38"
800-8635	35.0	1.38"	108.0	4.25"	10.0	.39"
800-8640	40.0	1.57"	108.0	4.25"	12.0	.47"

### Roll Pin

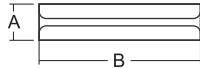

Stock Number	Dim. "A"		Dim. "B"	
	mm	in.	mm	in.
508-1080	10.0	.39"	80.0	3.10"

### Outer Tube

48.0 (3.8 Wall) mm  
1.89" (.15" Wall)



Stock Number	Length	
	m	in.
600-7548	1.5	59.06"
604-7548	1.0	39.37"

Shear Pin  
With Pin Hole

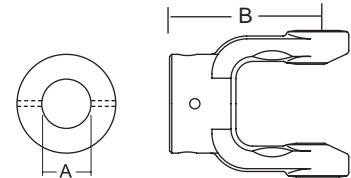

Stock Number	Dim. "A" Bore		Dim. "B"		Pinhole	
	mm	in.	mm	in.	mm	in.
802-8611	35.0	1.38"	105.0	4.13"	12.90	.50"
802-8620	31.8	1.25"	105.0	4.13"	6.35	.25"

### Guard

Order Bearings As Required

Stock Number	Overall Driveline Length	Bearing Kit (2-per kit)
902-3548	48"	961-3525
902-3560	60"	961-3525

Assembly instructions included with guard bearing kit  
NOTE: Guards must rotate freely on yokes

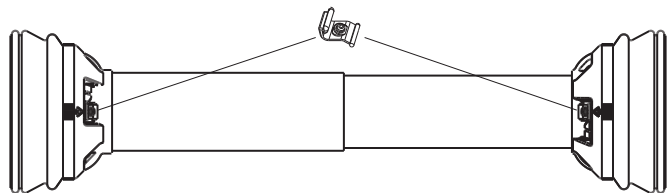

### Easy Lock™ Replacement Kit

Part Number: 13005000 (4-per Kit)



### Guard Chain Kit

Part Number: 13006500 (2-per Kit)



Insert the "S" hook through the guard loop and crimp shut

**2400 Series**

*Interchanges with Walterscheid*

**AW35**

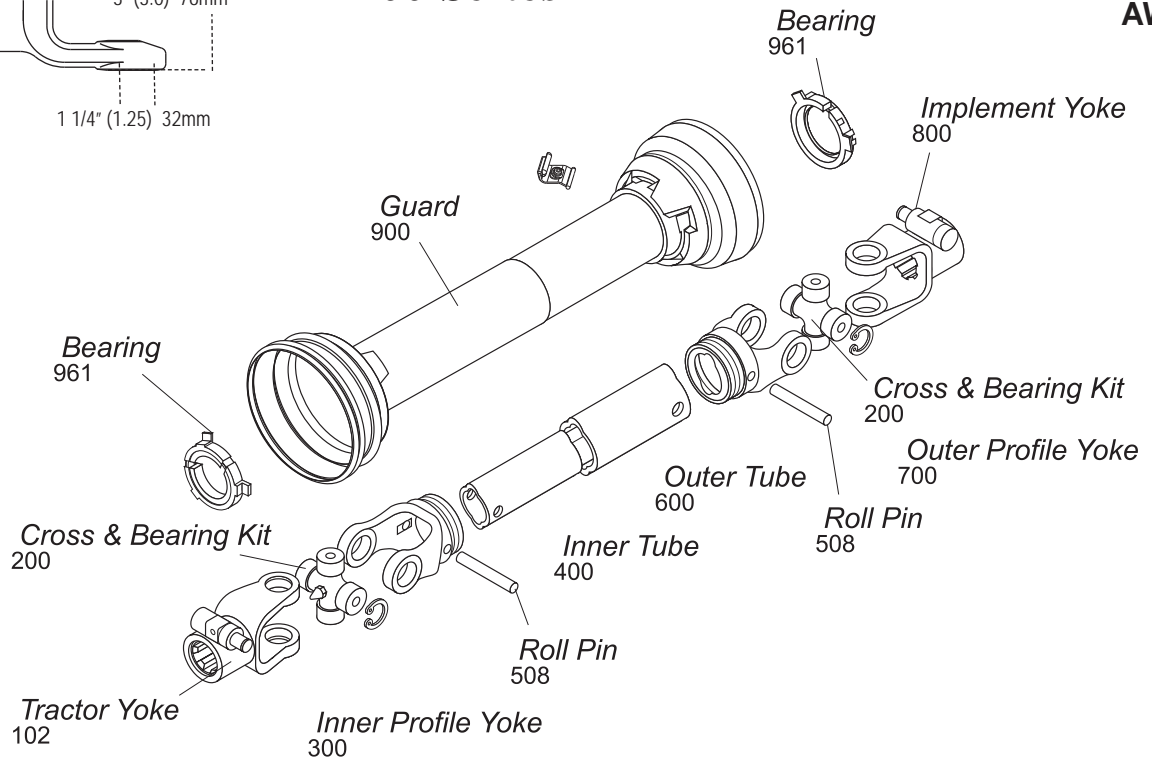
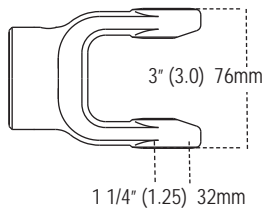

**Tractor Yoke**

**Safety Slide Lock**

Repair Kit —  
\*13004000  
\*\*19-15094  
\*\*\*13004020

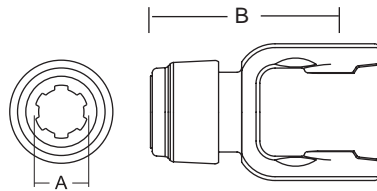

Stock Number	Dim. "A"	Dim. "B"	
	Bore	mm	in.
101-7606*	1 3/8" x 6 Spl.	126.0	4.96"
101-7618**	1 1/8" Hex	116.0	4.57"
101-7620***	1 3/4" x 20 Spl.	128.5	5.06"
101-7621*	1 3/8" x 21 Spl.	126.0	4.96"

**Cross & Bearing Kit**

**(R-Kit)**

(Recommended 8 hr. grease interval)

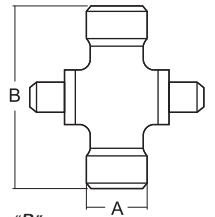

Snap Ring Located In Yoke

Stock Number	Dim. "A"		Dim. "B"	
	mm	in.	mm	in.
200-7676	32.0	1.26"	76.0	3.00"

**Quick Disconnect**

Repair Kit —  
\*13007138  
\*\*13007120

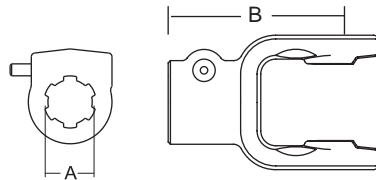

Stock Number	Dim. "A"	Dim. "B"	
	Bore	mm	in.
102-7606*	1 3/8" x 6 Spl.	116.0	4.57"
102-7620**	1 3/4" x 20 Spl.	116.0	4.57"
102-7621*	1 3/8" x 21 Spl.	116.0	4.57"

**Extended Lubrication  
Cross & Bearing Kit**

**(E-Kit)**

(Recommended 50 hr. grease interval)

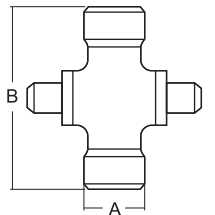

Snap Ring Located In Yoke

Stock Number	Dim. "A"		Dim. "B"	
	mm	in.	mm	in.
201-7676	32.0	1.26"	76.0	3.00"

**Ball Shear**

Repair Kit —  
\*13004000  
\*\*13004020

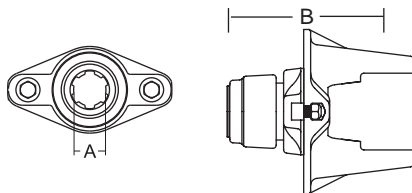

Stock Number	Dim. "A"	Dim. "B"		Shear Bolt
	Bore	mm	in.	
104-7606*	1 3/8" x 6 Spl.	140.7	5.54"	3/8" - 16 Gr. 5
104-7620**	1 3/4" x 20 Spl.	153.9	6.06"	3/8" - 16 Gr. 5
104-7621*	1 3/8" x 21 Spl.	140.7	5.54"	3/8" - 16 Gr. 5

**Inner Profile Yoke**

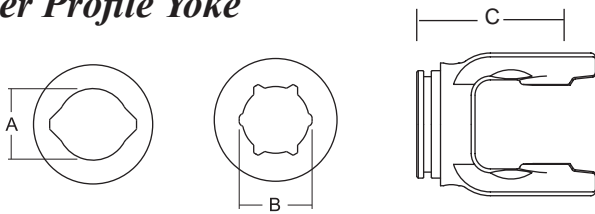

With Bearing Groove  
(Guard must rotate freely on yoke)

Stock Number	Dim. "A" Profile		Dim. "B" Profile		Dim. "C"	
	mm	in.	mm	in.	mm	in.
300-7639 (lemon)	39.5	1.56"			92.0	3.62"
300-7651 (star)			51.4	2.02"	92.0	3.62"

**Outer Profile Yoke**

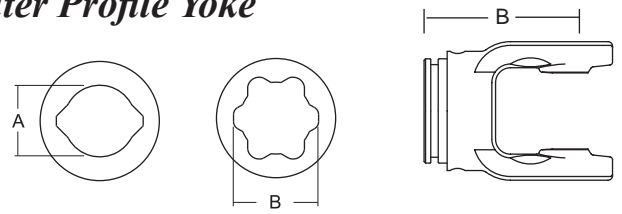

With Bearing Groove  
(Guard must rotate freely on yoke)

Stock Number	Dim. "A" Profile		Dim. "B" Profile		Dim. "C"	
	mm	in.	mm	in.	mm	in.
700-7648	48.0	1.89"			102.0	4.02"
700-7661			61.0	2.40"	102.0	4.02"

**Inner Tube**

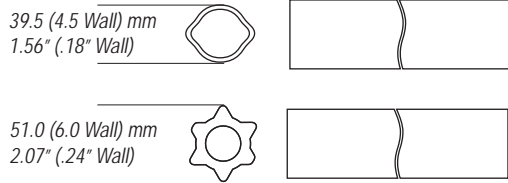

Stock Number	Length	
	m	in.
400-7539 (Lemon)	1.5	59.06"
400-7651 (Star)	1.5	59.06"
404-7539 (Lemon)	1.0	39.37"
404-7651 (Star)	1.0	39.37"

**Implement Yoke**

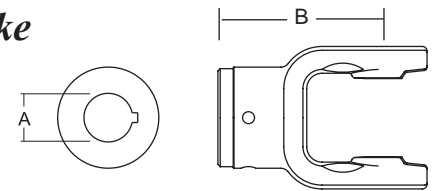

Round Bore  
With Keyway & Set Screw

Stock Number	Dim. "A" Bore		Dim. "B"		Standard Keyway	
	mm	in.	mm	in.	mm	in.
800-7610	31.8	1.25"	112.0	4.41"	6.4	.25"
800-7611	34.9	1.38"	112.0	4.41"	8.0	.31"
800-7624	38.1	1.50"	112.0	4.42"	8.0	.31"
800-7635	35.0	1.38"	112.0	4.41"	10.0	.39"
800-7640	40.0	1.57"	112.0	4.41"	12.0	.47"

**Roll Pin**

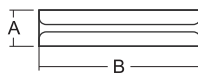

Stock Number	Dim. "A"		Dim. "B"	
	mm	in.	mm	in.
508-1075	10.0	.394"	75.0	2.95"

Shear Pin  
With Pin Hole

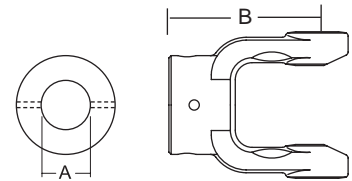

Stock Number	Dim. "A" Bore		Dim. "B"		Pinhole	
	mm	in.	mm	in.	mm	in.
802-7611	35.0	1.38"	105.0	4.13"	12.9	.50"
802-7630	30.0	1.18"	106.4	4.19"	10.0	.39"
802-7640	40.0	1.57"	106.4	4.19"	13.0	.512"

**Outer Tube**

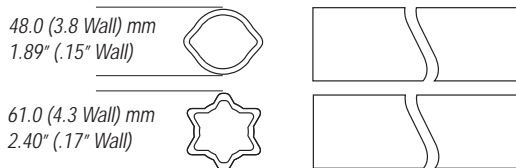

Stock Number	Length	
	m	in.
600-7548 (Lemon)	1.5	59.06"
600-7961 (Star)	1.5	59.06"
604-7548 (Lemon)	1.0	39.37"
604-7961 (Star)	1.0	39.37"

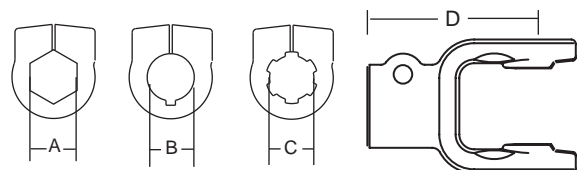

Clamp Yoke

Stock Number	Dim. "A" Bore			Dim. "D"	
	Dim. "A" Bore	Dim. "B" Bore	Dim. "C" Bore	mm	in.
807-7606			1 3/8" x 6 Spl.	116.0	4.57"
807-7618	1 1/8" Hex			116.0	4.57"
807-7620			1 3/4" x 20 Spl.	116.0	4.57"
807-7621			1 3/8" x 21 Spl.	116.0	4.57"
807-7622		*1 3/8" Rd. Bore		116.0	4.57"

\*w/ Keyway 10mm (.39")



## 2400 Series (cont'd.)

### Guard

Order Bearings As Required

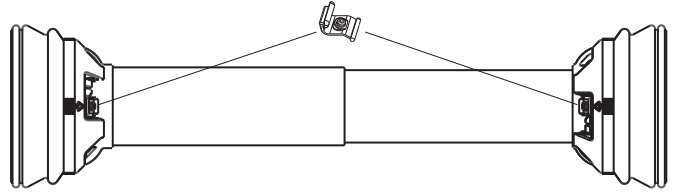

Stock Number	Overall Driveline Length	Bearing Kit (2-per kit)
902-3548	48"	961-3525
902-3560	60"	961-3525

Assembly instructions included with guard bearing kit  
NOTE: Guards must rotate freely on yokes

### Guard Chain Kit

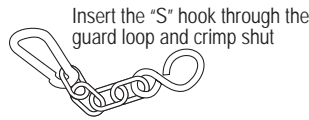

Insert the "S" hook through the guard loop and crimp shut

Part Number: 13006500 (2-per Kit)

### Easy Lock™ Replacement Kit

Part Number: 13005000 (4-per Kit)



### Drivelines

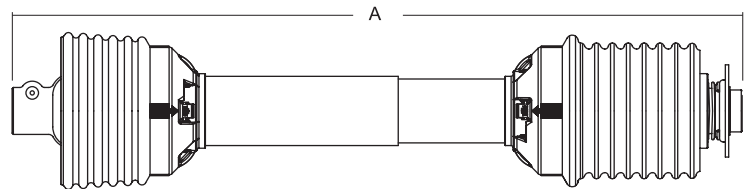

Stock Number	Overall Comp. Length Dim. "A"	Max. Running Length	Tractor Yoke	Implement Yoke
14007631	31"	39"	1 3/8" x 21 Spl. Safety Slide Lock	1 1/8" Hex Clamp
14007633	33"	41"	1 1/8" Hex Safety Slide Lock	1 1/8" Hex Clamp
14007635	35"	45"	1 3/8" x 21 Spl. Safety Slide Lock	1 1/8" Hex Clamp
14007640	40"	50"	1 3/8" x 6 Spl. OD	1 3/8" x 6 Spl. OD
14307645	45"	58"	1 3/8" x 6 Spl. OD	1 3/8" x 6 Spl. w/Overrunning Clutch
14007657	57"	77"	1 3/8" x 6 Spl.	1 3/8" x 6 Spl.

*Interchanges with Walterscheid*

# 2500 Series

**AW36**

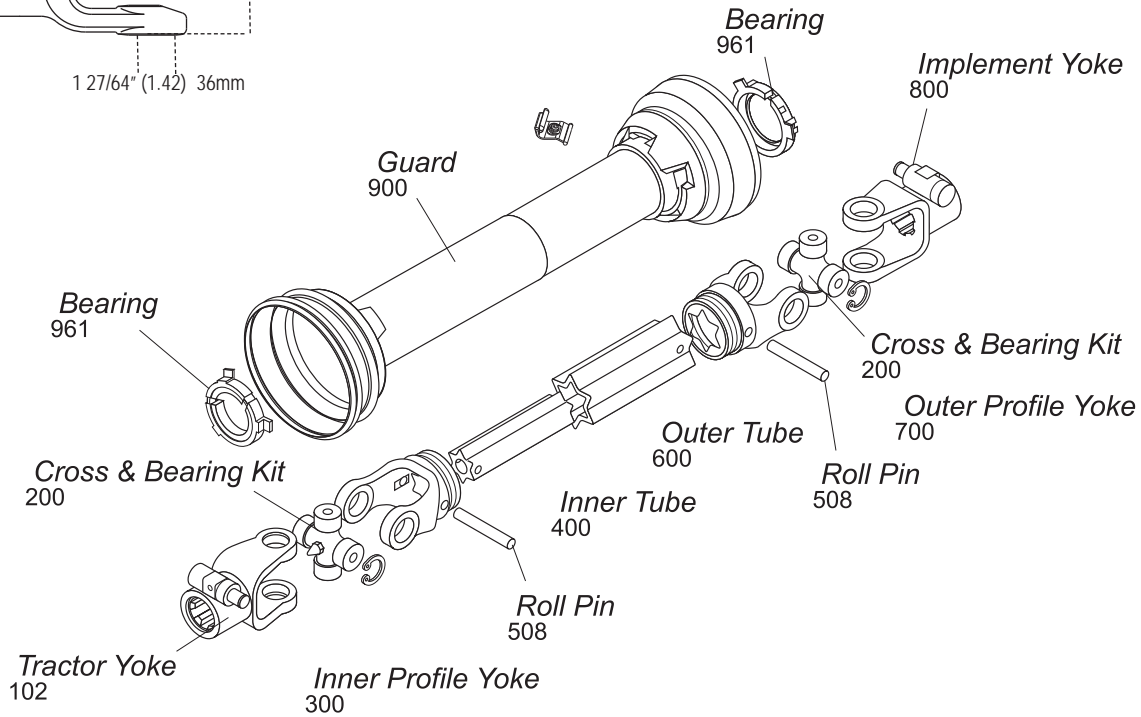
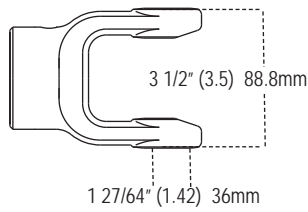

## Tractor Yoke

**Safety Slide Lock**  
Repair Kit —

\*13004000  
\*\*13004020

Stock Number	Dim. "A" Bore	Dim. "B"	
		mm	in.
101-7906*	1 3/8" x 6 Spl.	138.0	5.43"
101-7920**	1 3/4" x 20 Spl.	141.0	5.55"
101-7921*	1 3/8" x 21 Spl.	138.0	5.43"

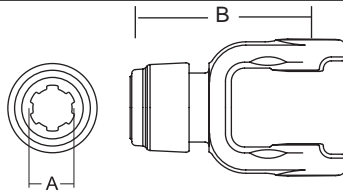

## Cross & Bearing Kit

**(R-Kit)**  
(Recommended 8 hr. grease interval)

Snap Ring Located In Yoke

Stock Number	Dim. "A"		Dim. "B"	
	mm	in.	mm	in.
200-7989	36.0	1.42"	88.8	3.50"

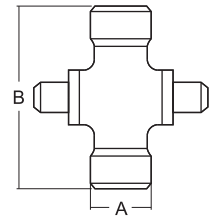

**Quick Disconnect**  
Repair Kit —

\*13007138  
\*\*13007120

Stock Number	Dim. "A" Bore	Dim. "B"	
		mm	in.
102-7906*	1 3/8" x 6 Spl.	121.0	4.76"
102-7920**	1 3/4" x 20 Spl.	121.0	4.76"
102-7921*	1 3/8" x 21 Spl.	121.0	4.76"

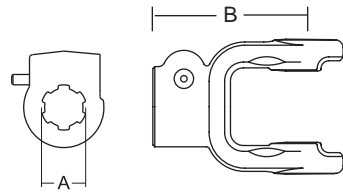

## Extended Lubrication Cross & Bearing Kit

**(E-Kit)**  
(Recommended 50 hr. grease interval)

Snap Ring Located In Yoke

Stock Number	Dim. "A"		Dim. "B"	
	mm	in.	mm	in.
201-7989	36.0	1.42"	88.8	3.50"

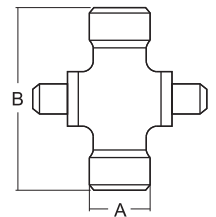

**Ball Shear**  
Repair Kit —

\*10004000  
\*\*13004020

Stock Number	Dim. "A" Bore	Dim. "B"		Shear Bolt
		mm	in.	
104-7906*	1 3/8" x 6 Spl.	148.5	5.85"	3/8" - 16 Gr. 5
104-7920**	1 3/4" x 20 Spl.	161.8	6.37"	3/8" - 16 Gr. 5
104-7921*	1 3/8" x 21 Spl.	148.5	5.85"	3/8" - 16 Gr. 5

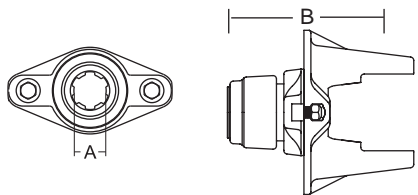

Replacement Shear Bolt Part No. 11-10445

## 2500 Series (cont'd.)

### Inner Profile Yoke

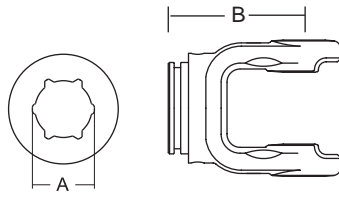

With Bearing Groove  
(Guard must rotate freely on yoke)

Stock Number	Dim. "A" Bore		Dim. "B"	
	mm	in.	mm	in.
300-7951	51.4	2.02"	106.0	4.17"

### Inner Tube



Stock Number	Length	
	m	in.
400-7651	1.5	59.06"
404-7651	1.0	39.37"

### Roll Pin

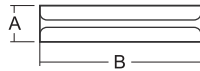

Stock Number	Dim. "A"		Dim. "B"	
	mm	in.	mm	in.
508-1090	10.0	.39"	90.0	3.54"

### Outer Tube



Stock Number	Length	
	m	in.
600-7961	1.5	59.06"
604-7961	1.0	39.37"

### Outer Profile Yoke

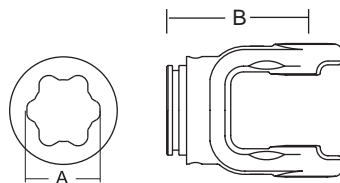

With Bearing Groove  
(Guard must rotate freely on yoke)

Stock Number	Dim. "A" Bore		Dim. "B"	
	mm	in.	mm	in.
700-7961	61.0	2.40"	111.0	4.37"

### Implement Yoke

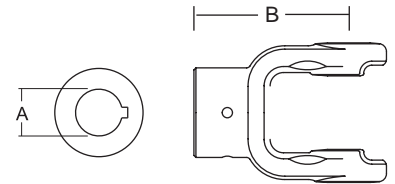

Round Bore  
With Keyway & Set Screw

Stock Number	Dim. "A" Bore		Dim. "B"		Standard Keyway	
	mm	in.	mm	in.	mm	in.
800-7922	35.0	1.38"	118.0	4.65"	8.0	.31"
800-7924	38.1	1.50"	118.0	4.65"	9.5	.38"
800-7928	44.4	1.75"	118.0	4.65"	10.0	.38"
800-7935	35.0	1.38"	118.0	4.65"	10.0	.39"

Spline Bore  
With Pin Hole

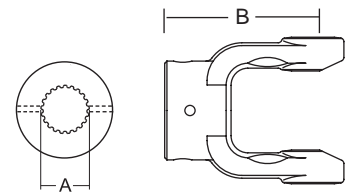

Stock Number	Dim. "A" Bore		Dim. "B"	
	mm	in.	mm	in.
801-7921	1 3/8" x 21 Spl.		110.0	4.33"

Shear Pin  
With Pin Hole

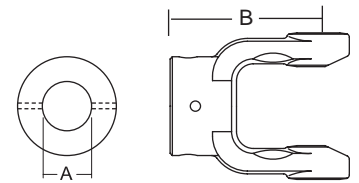

Stock Number	Dim. "A" Bore		Dim. "B"		Pinhole	
	mm	in.	mm	in.	mm	in.
802-7922	35.0	1.38"	117.6	4.63"	12.9	.50"
802-7924	38.1	1.50"	118.0	4.65"	12.9	.50"

### Clamp Yoke

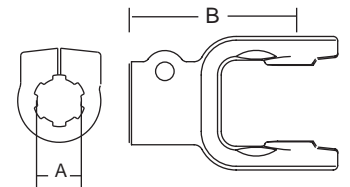

Stock Number	Dim. "A" Bore		Dim. "B"	
	mm	in.	mm	in.
807-7906	1 3/8" x 6 Spl.		121.0	4.76"
807-7918	1 3/4" x 6 Spl.		121.0	4.76"
807-7920	1 3/4" x 20 Spl.		121.0	4.76"
807-7921	1 3/8" x 21 Spl.		121.0	4.76"

**Guard**

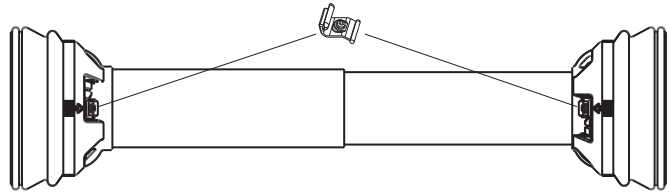

Order Bearings As Required

Stock Number	Overall Driveline Length	Bearing Kit (2-per kit)
902-3548	48"	961-3525
902-3560	60"	961-3525

Assembly instructions included with guard bearing kit  
NOTE: Guards must rotate freely on yokes

**Guard Chain Kit**

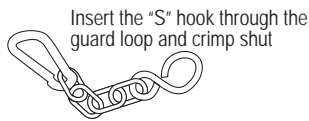

**Easy Lock™ Replacement Kit**

Part Number: 13005000 (4-per Kit)



Part Number: 13006500 (2-per Kit)

**Drivelines**

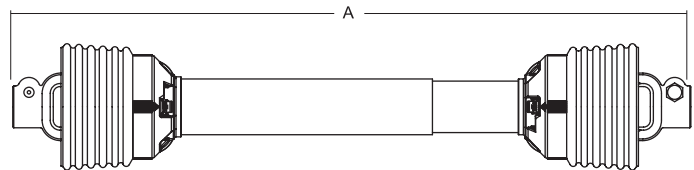

Stock Number	Overall Comp. Length Dim. "A"	Max. Running Length	Tractor Yoke	Implement Yoke
14007936	36"	47"	1 3/8" x 6 Spl. QD	1 3/8" x 6 Spl. QD
14007940	40"	51"	1 3/8" x 6 Spl. QD	1 3/8" x 6 Spl. QD
14007955	55"	73"	1 3/4" x 20 Spl. QD	1 3/8" x 21 Spl. w/Pinhole
14007957	57"	76"	1 3/8" x 6 Spl. QD	1 3/8" x 6 Spl. QD

**2600 Series**

**AW26**

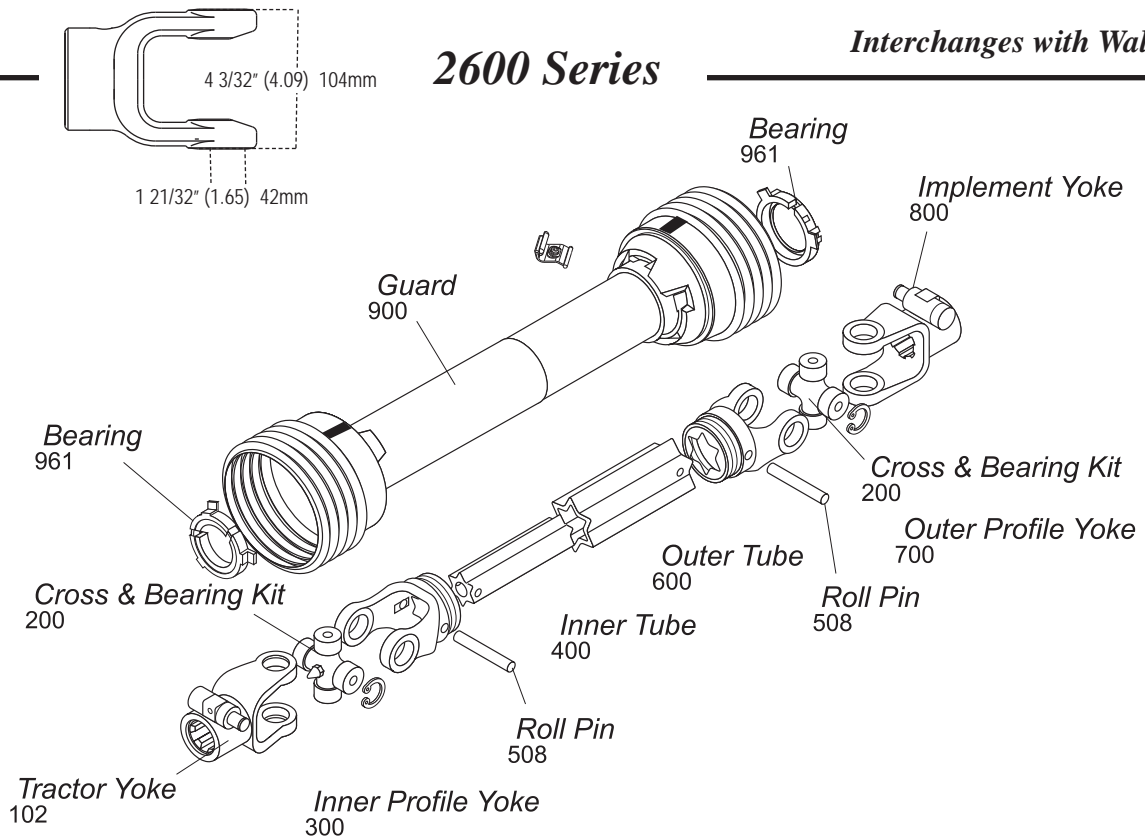

**Tractor Yoke**

**Safety Slide Lock**  
Repair Kit —

\*13004000  
\*\*13004020

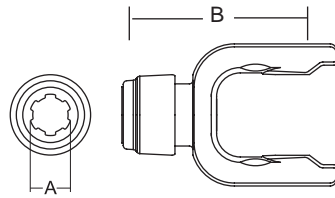

Stock Number	Dim. "A"	Dim. "B"	
	Bore	mm	in.
101-7006*	1 3/8" x 6 Spl.	150.0	5.91"
101-7020**	1 3/4" x 20 Spl.	150.0	5.91"
101-7021*	1 3/8" x 21 Spl.	150.0	5.91"

**Cross & Bearing Kit**

**(R-Kit)**  
(Recommended 8 hr. grease interval)

Snap Ring Located In Yoke

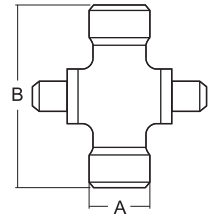

Stock Number	Dim. "A"		Dim. "B"	
	mm	in.	mm	in.
200-7004	42.0	1.65"	104.0	4.09"

**Quick Disconnect**  
Repair Kit —

\*13007138  
\*\*13007120

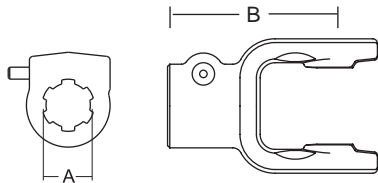

Stock Number	Dim. "A"	Dim. "B"	
	Bore	mm	in.
102-7006*	1 3/8" x 6 Spl.	131.0	5.15"
102-7020**	1 3/4" x 20 Spl.	131.0	5.15"
102-7021*	1 3/8" x 21 Spl.	131.0	5.15"

**Extended Lubrication**  
**Cross & Bearing Kit**

**(E-Kit)**  
(Recommended 50 hr. grease interval)

Snap Ring Located In Yoke

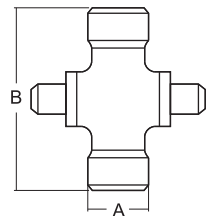

Stock Number	Dim. "A"		Dim. "B"	
	mm	in.	mm	in.
201-7004	42.0	1.65"	104.0	4.09"

### Inner Profile Yoke

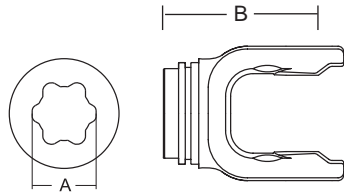

With Bearing Groove  
(Guard must rotate freely on yoke)

Stock Number	Dim. "A"		Dim. "B"	
	mm	in.	mm	in.
300-7061	61.0	2.40"	130.0	5.12"

### Outer Tube

71.5 (4.9 Wall) mm  
2.81" (.19" Wall)

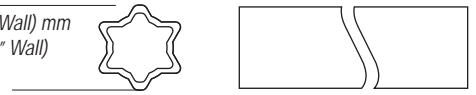

Stock Number	Length	
	m	in.
600-7071	1.5	59.06"
604-7071	1.0	39.37"

### Inner Tube

61.0 (4.3 Wall) mm  
2.40" (.17" Wall)

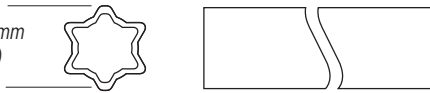

Stock Number	Length	
	m	in.
600-7961	1.5	59.06"
604-7961	1.0	39.37"

### Outer Profile Yoke

With Bearing Groove  
(Guard must rotate freely on yoke)

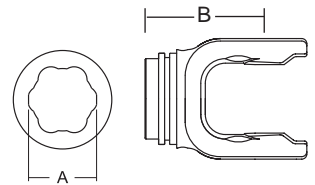

Stock Number	Dim. "A"		Dim. "B"	
	mm	in.	mm	in.
700-7071	71.7	2.82"	130.0	5.12"

### Roll Pin



Stock Number	Dim. "A"		Dim. "B"	
	mm	in.	mm	in.
508-1310	13.0	.50"	100.0	3.69"

### Implement Yoke

Round Bore  
With Keyway & Set Screw

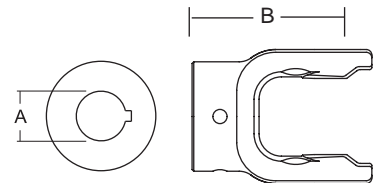

Stock Number	Dim. "A" Bore		Dim. "B"		Standard Keyway	
	mm	in.	mm	in.	mm	in.
800-7024	38.1	1.50"	130.0	5.12"	9.5	.37"
800-7026	41.3	1.63"	130.0	5.12"	9.5	.37"
800-7028	44.5	1.75"	130.0	5.12"	9.5	.37"
800-7032	50.8	2.00"	130.0	5.12"	12.7	.50"

### Easy Lock™ Replacement Kit

Part Number: 13005000 (4-per Kit)

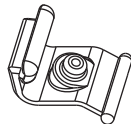

### Guard

Order Bearings As Required

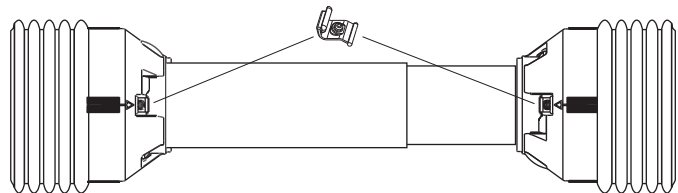

Stock Number	Overall Driveline Length	Bearing Kit (2-per kit)
900-4548	48"	961-4535
900-4560	60"	961-4535

Assembly instructions included with guard bearing kit  
NOTE: Guards must rotate freely on yokes

### Guard Chain Kit

Part Number: 13006500 (2-per Kit)

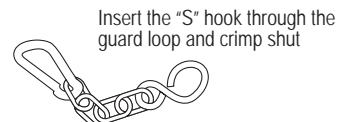

Insert the "S" hook through the guard loop and crimp shut

**II Series**

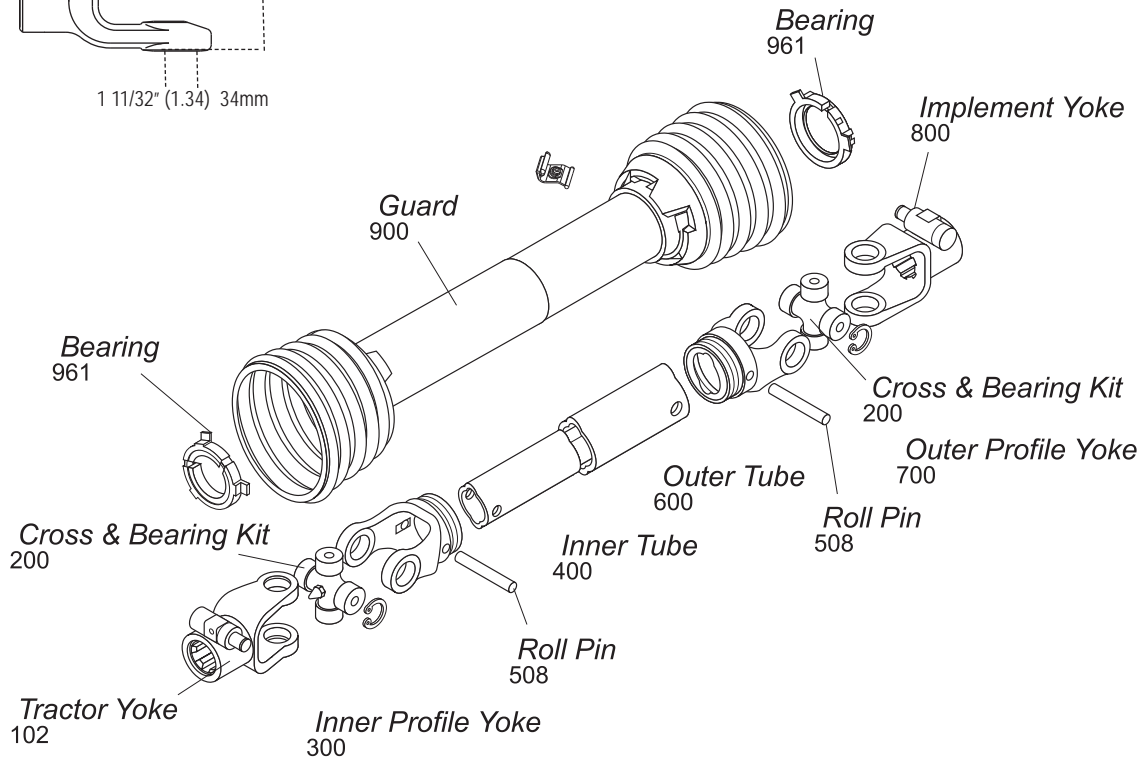
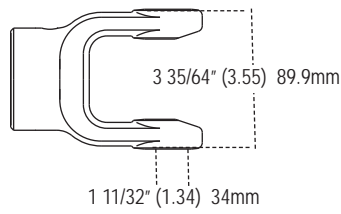

**Tractor Yoke**

**Quick Disconnect  
Repair Kit — \*13007138**

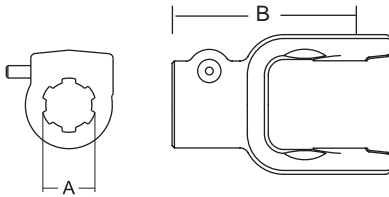

Stock Number	Dim. "A" Bore		Dim. "B"	
	mm	in.	mm	in.
102-7806*	1 3/8" x 6 Spl.		116.0	4.57"
102-7821*	1 3/8" x 21 Spl.		116.0	4.57"

**Inner Profile Yoke**

*With Bearing Groove  
(Guard must rotate freely on yoke)*

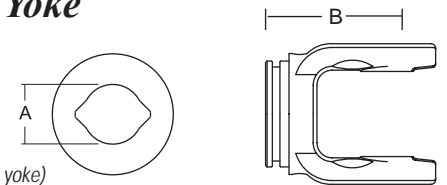

Stock Number	Dim. "A"		Dim. "B"	
	mm	in.	mm	in.
300-7839	39.5	1.56"	88.0	3.47"

**Cross & Bearing Kit  
(R-Kit)**

*(Recommended 8 hr. grease interval)*

*Snap Ring Located In Bushing*

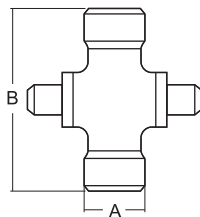

Stock Number	Dim. "A"		Dim. "B"	
	mm	in.	mm	in.
200-7890	34.0	1.34"	89.9	3.55"

**Outer Profile Yoke**

*With Bearing Groove  
(Guard must rotate freely on yoke)*

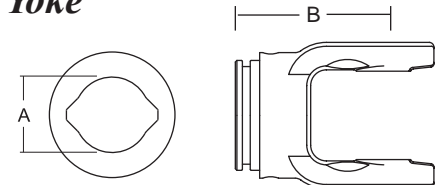

Stock Number	Dim. "A"		Dim. "B"	
	mm	in.	mm	in.
700-7848	48.0	1.89"	102.0	4.02"

# Profile Shafting and Tubing

## GERMAN-STYLE SHAFTING & TUBING

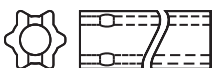

Lemon & Star Profile

## ITALIAN-STYLE SHAFTING & TUBING



Tri-Lobe Profile

SERIES	STOCK NO.	LENGTH		OUTSIDE DIAMETER		WALL THICKNESS		USE AS	PROFILE
		M	IN.	M	IN.	MM	IN.		
ByPy 1	400-6126	1.5	59.06	26.5	1.024	3.4	.138	Inner	Tri-Lobe
ByPy 1	404-6126	1	39.37	26.5	1.024	3.4	.138	Inner	Tri-Lobe
ByPy 1	600-6133	1.5	59.06	32.5	1.299	2.6	.102	Outer	Tri-Lobe
ByPy 1	604-6133	1	39.37	32.5	1.299	2.6	.102	Outer	Tri-Lobe
ByPy 2	400-6229	1.5	59.06	29	1.142	4.1	.134	Inner	Tri-Lobe
ByPy 2	404-6229	1	39.37	29	1.142	4.1	.134	Inner	Tri-Lobe
ByPy 2	600-6236	1.5	59.06	36	1.417	3.2	.134	Outer	Tri-Lobe
ByPy 2	604-6236	1	39.37	36	1.417	3.2	.134	Outer	Tri-Lobe
ByPy 3	600-6236	1.5	59.06	36	1.417	3.2	.134	Inner	Tri-Lobe
ByPy 3	604-6236	1	39.37	36	1.417	3.2	.134	Inner	Tri-Lobe
ByPy 3 & 4	600-6343	1.5	59.06	43.5	1.713	3.4	.138	Outer	Tri-Lobe
ByPy 3 & 4	604-6343	1	39.37	43.5	1.713	3.4	.138	Outer	Tri-Lobe
ByPy 4	400-6436	1.5	59.06	36	1.417	3.9	.157	Inner	Tri-Lobe
ByPy 4	404-6436	1	39.37	36	1.417	3.9	.157	Inner	Tri-Lobe
ByPy 5 & 6	400-6545	1.5	59.06	45	1.77	3.9	.150	Inner	Tri-Lobe
ByPy 5 & 6	404-6545	1	39.37	45	1.77	3.9	.150	Inner	Tri-Lobe
ByPy 5	600-6552	1.5	59.06	51.5	2.03	3	.120	Outer	Tri-Lobe
ByPy 5	604-6552	1	39.37	51.5	2.03	3	.120	Outer	Tri-Lobe
ByPy 6 & 7N	600-6654	1.5	59.06	54	2.13	4.5	.180	Outer	Tri-Lobe
ByPy 6 & 7N	604-6654	1	39.37	54	2.13	4.5	.180	Outer	Tri-Lobe
ByPy 7N	400-6745	1.5	59.06	45	1.77	5.4	.210	Inner	Tri-Lobe
ByPy 7N	404-6745	1	39.37	45	1.77	5.4	.210	Inner	Tri-Lobe
ByPy 8	600-6654	1.5	59.06	54	2.13	4.5	.180	Inner	Tri-Lobe
ByPy 8	604-6654	1	39.37	54	2.13	4.5	.180	Inner	Tri-Lobe
ByPy 8 & 9	600-6863	1.5	59.06	63	2.48	4.1	.161	Outer	Tri-Lobe
ByPy 8 & 9	604-6863	1	39.37	63	2.48	4.1	.161	Outer	Tri-Lobe
ByPy 9	400-6954	1.5	59.06	54	2.13	4.9	.190	Inner	Tri-Lobe
ByPy 9	404-6954	1	39.37	54	2.13	4.9	.190	Inner	Tri-Lobe
W/S 2100	400-7123	1.5	59.06	23.5	0.93	SOLID		Inner	Lemon
W/S 2100	404-7123	1	39.37	23.5	0.93			Inner	Lemon
W/S 2100	600-7130	1.5	59.06	30	1.19	2.9	.114	Outer	Lemon
W/S 2100	604-7130	1	39.37	30	1.19	2.9	.114	Outer	Lemon
W/S I, 2200 & 2300	400-7234	1.5	59.06	34.5	1.36	4	.160	Inner	Lemon
W/S I, 2200 & 2300	404-7234	1	39.37	34.5	1.36	4	.160	Inner	Lemon
W/S I, 2200 & 2300	600-7241	1.5	59.06	41	1.61	2.9	.114	Outer	Lemon
W/S I, 2200 & 2300	604-7241	1	39.37	41	1.61	2.9	.110	Outer	Lemon
W/S 2400 & 220/720	400-7539	1.5	59.06	39.5	1.56	4.5	.180	Inner	Lemon
W/S 2400 & 220/720	404-7539	1	39.37	39.5	1.56	4.5	.180	Inner	Lemon
W/S 2400 & 220/720	600-7548	1.5	59.06	48	1.89	3.8	.150	Outer	Lemon
W/S 2400 & 220/720	604-7548	1	39.37	48	1.89	3.8	.150	Outer	Lemon
W/S 2400 & 2500	400-7651	1.5	59.06	51	2.07	6	.240	Inner	Star
W/S 2400 & 2500	404-7651	1	39.37	51	2.07	6	.240	Inner	Star
W/S 2400 & 2500	600-7961	1.5	59.06	61	2.4	4.3	.170	Outer	Star
W/S 2400 & 2500	604-7961	1	39.37	61	2.4	4.3	.170	Outer	Star
W/S 2600	600-7961	1.5	59.06	61	2.4	4.3	.170	Inner	Star
W/S 2600	604-7961	1	39.37	61	2.4	4.3	.170	Inner	Star
W/S 2600	600-7071	1.5	59.06	71.5	2.81	4.9	.190	Outer	Star
W/S 2600	604-7071	1	39.37	71.5	2.81	4.9	.190	Outer	Star



# Metric Replacement Drivelines

Interchanges with Bondioli & Pavesi and Walterscheid

## All Purpose Drivelines

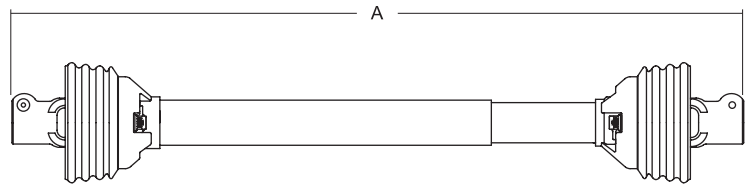

Stock Number	Series	Overall Comp. Length Dim. "A"	Max. Running Length	Tractor Yoke	Implement Yoke
14006137	BYPY 1	37"	53"	1 3/8" x 6 Spl. QD	1 3/8" x 6 Spl. QD
14006247	BYPY 2	47"	70"	1 3/8" x 6 Spl. QD	1 3/8" x 6 Spl. QD
14006438	BYPY 4	38"	54"	1 3/8" x 6 Spl. QD	1 3/8" x 6 Spl. QD
14006455	BYPY 4	55"	83"	1 3/8" x 6 Spl. QD	1 3/8" x 6 Spl. QD
14006448	BYPY 4	48"	70"	1 3/8" x 6 Spl. QD	1 3/8" x 6 Spl. QD
14006543	BYPY 5	43"	60"	1 3/8" x 6 Spl. QD	1 3/8" x 6 Spl. QD
14006555	BYPY 5	55"	83"	1 3/8" x 6 Spl. QD	1 3/8" x 6 Spl. QD
14006642	BYPY 6	42"	57"	1 3/8" x 6 Spl. QD	1 3/8" x 6 Spl. QD
14006644	BYPY 6	44"	60"	1 3/8" x 6 Spl. QD	1 3/8" x 6 Spl. QD
14006655	BYPY 6	55"	76"	1 3/8" x 6 Spl. QD	1 3/8" x 6 Spl. QD
14006657	BYPY 6	57"	83"	1 3/8" x 6 Spl. QD	1 3/8" x 6 Spl. QD
14006846	BYPY 8	46"	63"	1 3/8" x 6 Spl. QD	1 3/8" x 6 Spl. QD
14006857	BYPY 8	57"	77"	1 3/8" x 6 Spl. QD	1 3/8" x 6 Spl. QD
14016542	BYPY 5	42"	60"	1 3/8" x 6 Spl. QD	1 3/8" x 6 Spl. QD
14016666	BYPY 6	66"	99"	1 3/8" x 21 Spl. QD	1 1/2" Rd.
14046148	BYPY 1	48"	70"	1 3/8" x 6 Spl. QD	*
14046248	BYPY 2	48"	70"	1 3/8" x 6 Spl. QD	*
14046260	BYPY 2	60"	89"	1 3/8" x 6 Spl. QD	*
14046348	BYPY 3	48"	70"	1 3/8" x 6 Spl. QD	*
14046360	BYPY 3	60"	90"	1 3/8" x 6 Spl. QD	*
14046448	BYPY 4	48"	70"	1 3/8" x 6 Spl. QD	*
14046460	BYPY 4	60"	89"	1 3/8" x 6 Spl. QD	*
14046548	BYPY 5	48"	70"	1 3/8" x 6 Spl. QD	*
14046560	BYPY 5	60"	89"	1 3/8" x 6 Spl. QD	*
14046648	BYPY 6	48"	70"	1 3/8" x 6 Spl. QD	*
14046660	BYPY 6	60"	89"	1 3/8" x 6 Spl. QD	*
14046748	BYPY 7	48"	70"	1 3/8" x 6 Spl. QD	*
14046760	BYPY 7	60"	83"	1 3/8" x 6 Spl. QD	*
14046848	BYPY 8	48"	70"	1 3/8" x 6 Spl. QD	*
14046860	BYPY 8	60"	86"	1 3/8" x 6 Spl. QD	*
14046948	BYPY 9	48"	70"	1 3/8" x 6 Spl. QD	*
14046960	BYPY 9	60"	86"	1 3/8" x 6 Spl. QD	*
14066644	BYPY 6	44"	60"	1 3/8" x 21 Spl. QD	1 3/8" x 21 Spl. QD
14066846	BYPY 8	46"	63"	1 3/8" x 21 Spl. QD	1 3/8" x 21 Spl. QD

\* Drivelines are furnished without Cross & Bearing Kit and Implement Yoke. Select kit and yoke as required.

## Catfish Pond Driveline

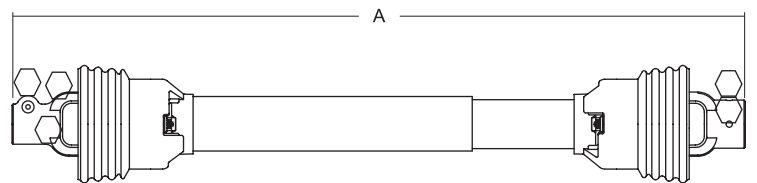

Stock Number	Series	Overall Comp. Length Dim. "A"	Max. Running Length	Tractor Yoke	Implement Yoke
14006424	BYPY 4	48"	70"	1 3/8" x 6 Spl. QD	1 1/2" Rd
14006524	BYPY 5	48"	70"	1 3/8" x 6 Spl. QD	1 1/2" Rd
14006624	BYPY 6	48"	70"	1 3/8" x 6 Spl. QD	1 1/2" Rd
14016524	BYPY 5	48"	70"	1 3/8" x 21 Spl. QD	1 1/2" Rd
14016624	BYPY 6	48"	70"	1 3/8" x 21 Spl. QD	1 1/2" Rd

# Metric Replacement Driveline

Interchanges with Bondioli & Pavesi and Walterscheid

## Disc Mower

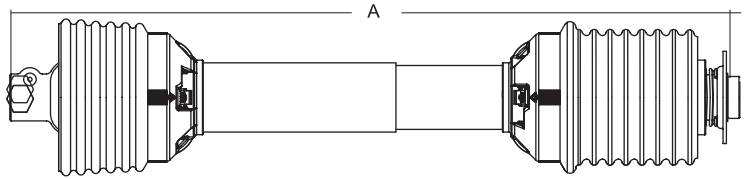

Stock Number	Series	Overall Comp. Length Dim. "A"	Max. Running Length	Tractor Yoke	Implement Yoke
14306538	BYPY 5	38"	55"	1 3/8" x 6 Spl. QD	1 3/8" x 6 Spl. QD w/Overrunning Clutch
14306639	BYPY 6	39"	52"	1 3/8" x 6 Spl. QD	1 3/8" x 6 Spl. QD w/Overrunning Clutch
14307645	W/S 2400	45"	58"	1 3/8" x 6 Spl. QD	1 3/8" x 6 Spl. QD w/Overrunning Clutch

## Fertilizer Spreader

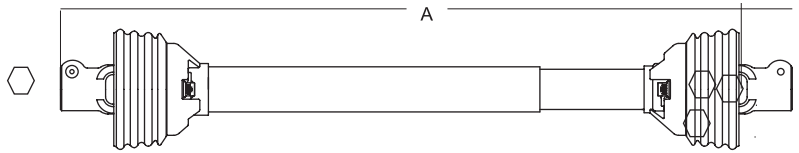

Stock Number	Series	Overall Comp. Length Dim. "A"	Max. Running Length	Tractor Yoke	Implement Yoke
14006127	BYPY 1	27"	37"	1 3/8" x 6 Spl. QD	1 3/8" x 6 Spl. QD
14006135	BYPY 1	35"	50"	1 3/8" x 6 Spl. QD	1 3/8" x 6 Spl. QD

## Finishing Mower

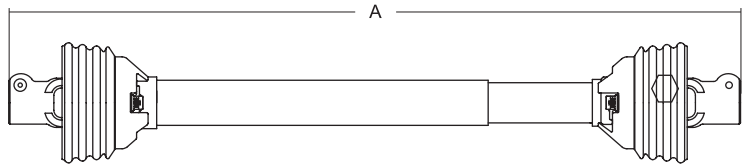

Stock Number	Series	Overall Comp. Length Dim. "A"	Max. Running Length	Tractor Yoke	Implement Yoke
14006340	BYPY 3	40"	57"	1 3/8" x 6 Spl. QD	1 3/8" x 6 Spl. QD
14006446	BYPY 4	46"	67"	1 3/8" x 6 Spl. QD	1 3/8" x 6 Spl. QD
14006637	BYPY 6	37"	50"	1 3/8" x 6 Spl. QD	1 3/8" x 6 Spl. QD

## Hammer Mill

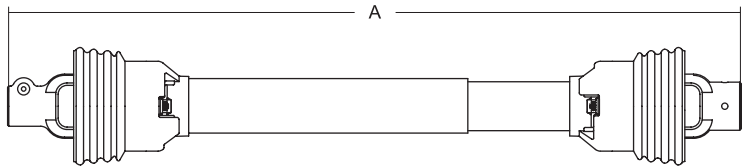

Stock Number	Series	Overall Comp. Length Dim. "A"	Max. Running Length	Tractor Yoke	Implement Yoke
14006628	BYPY 6	57"	83"	1 3/8" x 6 Spl. QD	1 3/4" Rd.
14006748	BYPY 7	48"	70"	1 3/8" x 6 Spl. QD	1 3/4" Rd.

## Hay Tedder

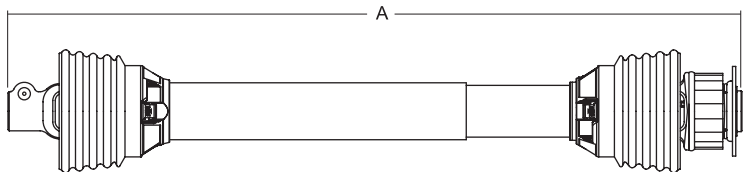

Stock Number	Series	Type	Overall Comp. Length Dim. "A"	Max. Running Length	Tractor Yoke	Implement Yoke
14206252	BYPY 2*	2-Rotor	52"	77"	1 3/8" x 6 Spl. QD	1 3/8" x 6 Spl. Radial Pin Clutch
14206454	BYPY 4**	4-Rotor	54"	79"	1 3/8" x 6 Spl. QD	1 3/8" x 6 Spl. Radial Pin Clutch

\*Light Duty  
\*\*Heavy Duty

# Metric Replacement Drivelines

Interchanges with Bondioli & Pavesi and Walterscheid

## Peanut Harvester Non - CV

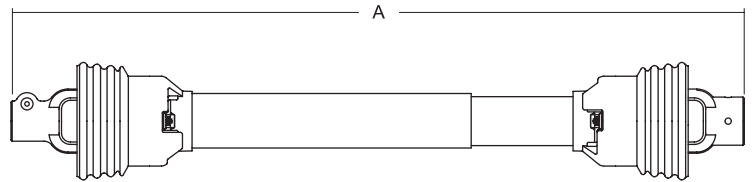

Stock Number	Series	Overall Comp. Length Dim. "A"	Max. Running Length	Tractor Yoke	Implement Yoke
14007955 (Star)	W/S 2500	55"	73"	1 3/4" × 20 Spl. QD	1 3/8" × 21 Spl. w/Pinhole

## Post Hole Digger

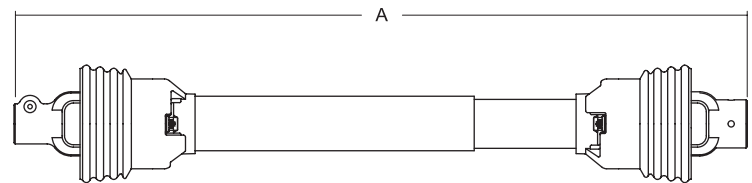

Stock Number	Series	Overall Comp. Length Dim. "A"	Max. Running Length	Tractor Yoke	Implement Yoke
14006252	BYPY 2*	52"	79"	1 3/8" × 6 Spl. QD	1 1/4" Rd w/Pinhole
14006453	BYPY 4**	53"	79"	1 3/8" × 6 Spl. QD	1 1/4" Rd w/Pinhole

\*Light Duty  
\*\*Heavy Duty

## Rotary Cutter

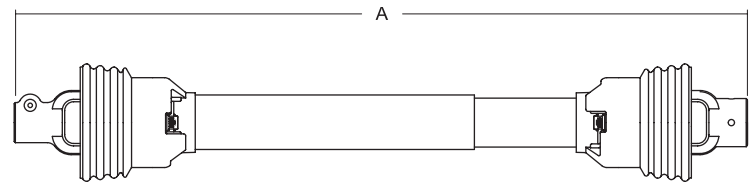

Stock Number	Series	Type	Overall Comp. Length Dim. "A"	Max. Running Length	Tractor Yoke	Implement Yoke
14006251	BYPY 2	Pull (Towed)	51"	76"	1 3/8" × 6 Spl. QD	1 3/8" Rd w/Pinhole
14006432	BYPY 4	4 ft. Lift (3-pt. Hitch)	32"	43"	1 3/8" × 6 Spl. QD	1 3/8" Rd w/ Pinhole
14006436	BYPY 4	5 ft. Lift (3-pt. Hitch)	36"	50"	1 3/8" × 6 Spl. QD	1 3/8" Rd w/ Pinhole
14006442	BYPY 4	6 ft. Lift (3-pt. Hitch)	42"	60"	1 3/8" × 6 Spl. QD	1 3/8" Rd w/ Pinhole
14006451	BYPY 4	Pull (Towed)	51"	76"	1 3/8" × 6 Spl. QD	1 3/8" Rd w/ Pinhole
14006542	BYPY 5	6 ft. Lift (3-pt. Hitch)	42"	60"	1 3/8" × 6 Spl. QD	1 3/8" Rd w/ Pinhole
14006546	BYPY 5	6 ft. Heavy Duty	46"	67"	1 3/8" × 6 Spl. QD	1 3/8" × 6 Spl. QD
14006551	BYPY 5	6 ft. Lift (3-pt. Hitch)	51"	76"	1 3/8" × 6 Spl. QD	1 3/8" Rd.
14006652	BYPY 6	7 ft. Lift (3-pt. Hitch)	52"	76"	1 3/8" × 6 Spl. QD	1 3/8" Rd w/ Pinhole

## Rotary Cutter/Tiller

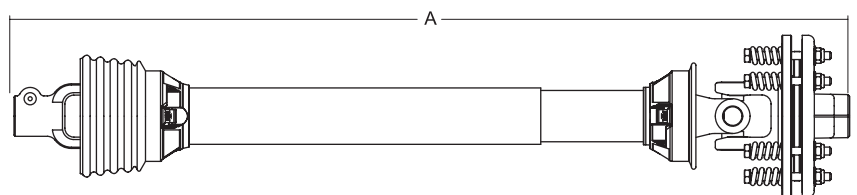

Stock Number	Series	Type	Overall Comp. Length Dim. "A"	Max. Running Length	Tractor Yoke	Implement Yoke
14106438	BYPY 4	Pull (Towed)	38"	52"	1 3/8" × 6 Spl. QD	1 3/8" × 6 Spl. w/Friction Clutch
14106546	BYPY 5	Pull (Towed)	46"	65"	1 3/8" × 6 Spl. QD	1 3/8" × 6 Spl. w/Friction Clutch
14106654	BYPY 6	7 ft. Lift (3-pt. Hitch)	54"	78"	1 3/8" × 6 Spl. QD	1 3/8" × 6 Spl. w/Friction Clutch
14106233	BYPY 2	Pull (Towed)	33"	58"	1 3/8" × 6 Spl. QD	1 3/8" × 6 Spl. w/Friction Clutch
14106436	BYPY 4	Pull (Towed)	36"	48"	1 3/8" × 6 Spl. QD	1 3/8" × 6 Spl. w/Friction Clutch
14106660	BYPY 6	7 ft. Lift (3-pt. Hitch)	60"	89"	1 3/8" × 6 Spl. QD	1 3/4" × 20 Spl. w/Friction Clutch
14106661	BYPY 6	7 ft. Lift (3-pt. Hitch)	61"	92"	1 3/4" × 20 Spl. QD	1 3/4" × 20 Spl. w/Friction Clutch

## Q.D. Repair Kit

---

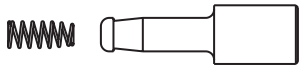

Stock No. 13006121

Repair Kit for 1 3/8" x 6 Spl. & 1 3/8" x 21 Spl.  
Bondioli & Pavesi Series 1,2,3,4,5,6,7N, 8 and 9

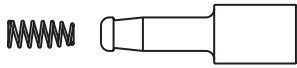

Stock No. 13006720

Repair Kit for 7N Series  
1 3/4" x 20 Spl.



Stock No. 13007120

Repair Kit for 1 3/4" x 20 Spl.  
All Walterscheid Series  
Spring Internal to Yoke



Stock No. 13007138

Repair Kit for 1 3/8" x 6 Spl. & 1 3/8" x 21 Spl.  
for all Walterscheid Series

---

## Locking Device Repair Kit

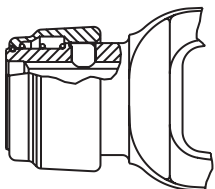

### **\*Auto-Lok/Safety Slide Lock**

Stock No. 13004000

Repair Kit for Weasler Auto-Lok and  
Safety Slide Lock  
6 Spline & 21 Spline

\* This repair kit contains both balls & pawls. When repairing the "Safety Slide Lock" use the pawls only and discard the balls.  
When repairing the "Auto-Lok" use both the balls and the pawls.

# WORLD WIDE 80° CONSTANT VELOCITY

- LIGHT WEIGHT AND COMPACT DESIGN FOR HANDLING EASE
- METRIC NOW HAS SEALED CENTER HOUSING WITH NORTH AMERICAN-STYLE BALL AND SOCKET SYSTEM

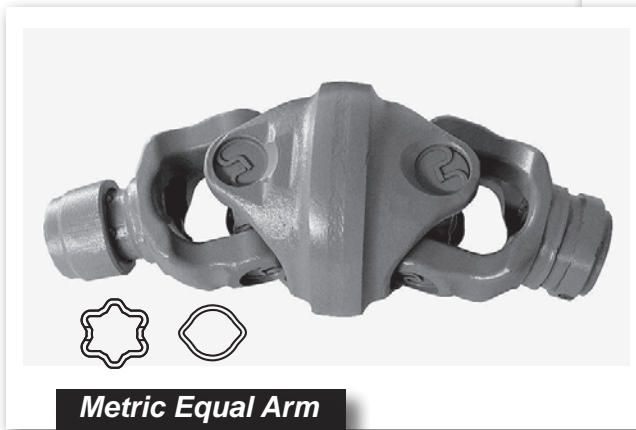

**Metric Equal Arm  
80° C.V. Joint**

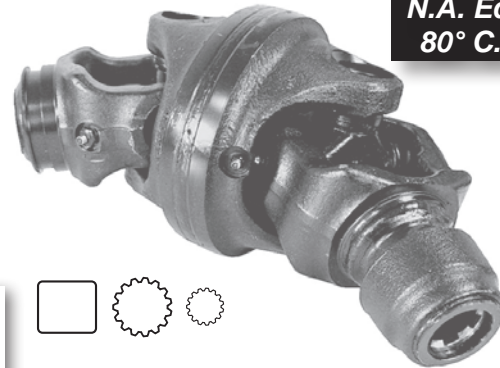

**N.A. Equal Arm  
80° C.V. Joint**



**80° Equal Arm  
Tractor Yokes**



**Bushing Lube  
Cross Kits**



**Easy Lock Guarding**



**Metric  
Old-Style**

**Metric & Domestic  
New-Style**

- SINGLE GUARD POSITION WILL ACCESS ALL GREASE ZERK LOCATIONS ON C.V.
- GUARD SYSTEMS ARE CE AND ISO COMPLIANT
- ARTICULATED GUARD SYSTEM PROVIDES FULL COVERAGE AT MAXIMUM ANGLE
- METRIC GUARD IS NOW UPGRADED TO THE PATENTED NORTH AMERICAN AND USER-FRIENDLY EASY LOCK SYSTEM

**Higher Value - Smarter Solutions**



**Weasler**<sup>®</sup>

## Aftermarket Product Guide



# Constant Velocity

## Drivelines and Components

# NORTH AMERICAN SECTION

## 80° CV Category 3 / 14

### UNEQUAL ARM

### EQUAL ARM

#### Tractor Yoke

**Auto-Lok**  
Repair Kit - 13004000

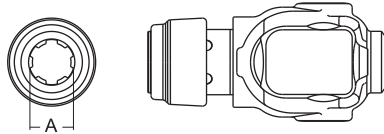

Stock Number	Dim. "A" Bore
111-1406	1 3/8" x 6 Spl.

#### Cross & Bearing Kit

**(R-Kit)**  
(Recommended 8 hr. grease interval)

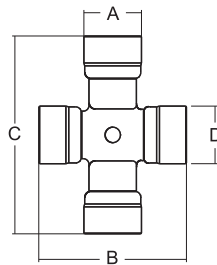

Stock Number	Dim. "A"	Dim. "B"	Dim. "C"	Dim. "D"
200-1430	1 1/8"	2 5/8"	4 1/4"	1 1/8"

#### Extended Lubrication

#### Cross & Bearing Kit

**(E-Kit)**  
(Recommended 50 hr. grease interval)

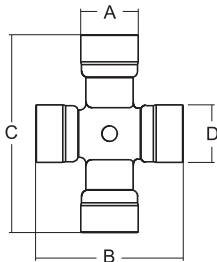

Stock Number	Dim. "A"	Dim. "B"	Dim. "C"	Dim. "D"
201-1430	1 1/8"	2 5/8"	4 1/4"	1 1/8"

#### Center Housing

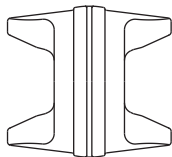

Stock Number	Notes
550-1430	No Longer Available In Unequal Arm
Order Replacement Joint & Shaft Assembly Part # 15553800 or 15653800	

#### Yoke & Shaft

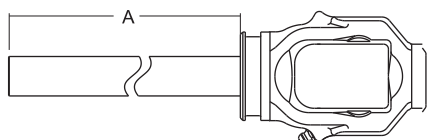

Stock Number	Notes
10101400	No Longer Available In Unequal Arm
Order Replacement Joint & Shaft Assembly Part # 15553800 or 15653800	

#### Tractor Yoke

**Auto-Lok**  
Repair Kit - 13004000

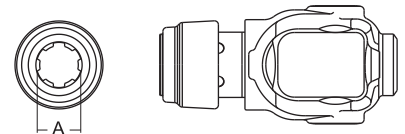

Stock Number	Dim. "A" Bore
121-1406	1 3/8" x 6 Spl.
121-1421	1 3/8" x 21 Spl.

#### Cross & Bearing Kit

**(R-Kit)**  
(Recommended 8 hr. grease interval)

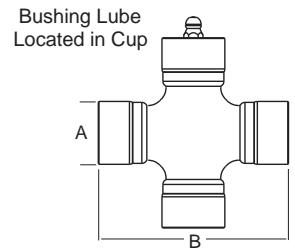

Stock Number	Dim. "A"	Dim. "B"
203-0310	27mm (1.07")	81.78mm (3.22")

#### Extended Lubrication

#### Cross & Bearing Kit

**(E-Kit)**  
(Recommended 50 hr. grease interval)

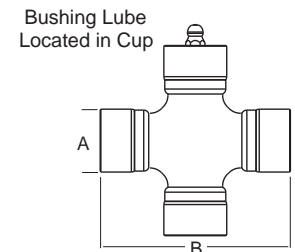

Stock Number	Dim. "A"	Dim. "B"
204-0310	27mm (1.07")	81.78mm (3.22")

#### Center Housing

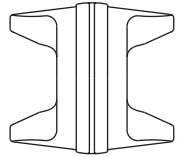

Stock Number	Notes
515-1430	

#### Yoke & Shaft

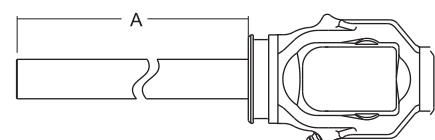

Stock Number	Shaft Size	Dim. "A" Shaft Length
10103800	1" x 1 1/8" Rect.	27"

CONSTANT VELOCITY

# NORTH AMERICAN SECTION

## 80° CV Category 3 / 14

### UNEQUAL ARM

### EQUAL ARM

#### Yoke, Tube & Sleeve Assembly

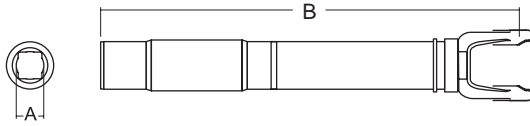

Stock Number	Dim. "A" Bore	Overall Driveline Length	Dim. "B" *CL to end of Sleeve
11101448	1" x 1 1/8" Rect.	48"	31.63"

\*CL= Centerline

#### Yoke, Tube & Sleeve Assembly w/Guard

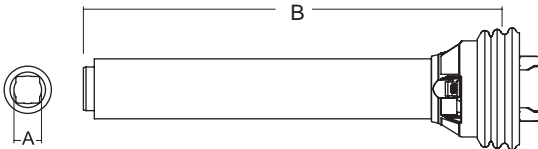

Stock Number	Dim. "A" Bore	Overall Driveline Length	Dim. "B" *CL to end of Sleeve
17501448	1" x 1 1/8" Rect.	48"	31.63"

\*CL= Centerline

#### Joint & Shaft

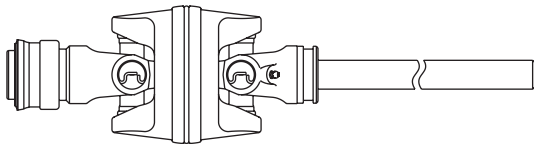

Stock Number	Description	
15501406	No Longer Available In Unequal Arm Use Part No. 15553800	
15601421	No Longer Available In Unequal Arm Use Part No. 15653800	

#### Joint & Shaft w/Guard

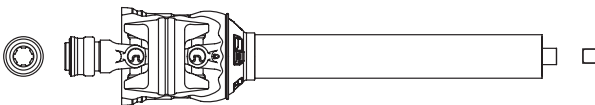

Stock Number	Description	
19501406	No Longer Available In Unequal Arm Use Part No. 19553800	
19601421	No Longer Available In Unequal Arm Use Part No. 19653800	

#### Yoke, Tube & Sleeve Assembly

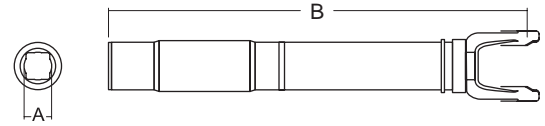

Stock Number	Dim. "A" Bore	Overall Driveline Length	Dim. "B" *CL to end of Sleeve
11101448	1" x 1 1/8" Rect.	48"	31.63"

\*CL= Centerline

#### Yoke, Tube & Sleeve Assembly w/Guard

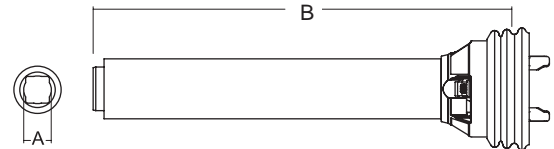

Stock Number	Dim. "A" Bore	Overall Driveline Length	Dim. "B" *CL to end of Sleeve
17501448	1" x 1 1/8" Rect.	48"	31.63"

\*CL= Centerline

#### Joint & Shaft

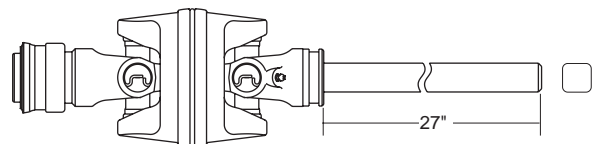

Stock Number	Shaft Size	Shaft Length	Tractor Yoke
15553800	1" x 1 1/8" Rect.	27"	1 3/8" x 6 Spl.
15653800	1" x 1 1/8" Rect.	27"	1 3/8" x 21 Spl.

#### Joint & Shaft w/Guard

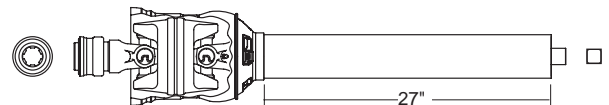

Stock Number	Shaft Size	Shaft Length	Tractor Yoke
19553800	1" x 1 1/8" Rect.	27"	1 3/8" x 6 Spl.
19653800	1" x 1 1/8" Rect.	27"	1 3/8" x 21 Spl.

CONSTANT VELOCITY



# NORTH AMERICAN SECTION

## 80° CV Category 3 / 14

### UNEQUAL ARM

### EQUAL ARM

#### Guard

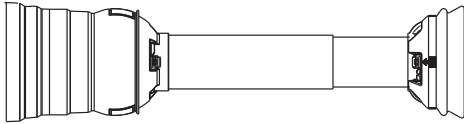

Bearings supplied with Guard

Stock Number	Overall Driveline Length	Bearing Kit (2-per kit)
912-1448	48"	921-1400
912-1458	58"	921-1400
912-1467	67"	921-1400

Assembly instructions included with guard bearing kit  
NOTE: Guards must rotate freely on yokes

#### Guard



Bearings supplied with Guard

Stock Number	Overall Driveline Length	Bearing Kit (2-per kit)
912-1448	48"	921-1400
912-1458	58"	921-1400
912-1467	67"	921-1400

Assembly instructions included with guard bearing kit  
NOTE: Guards must rotate freely on yokes

CONSTANT VELOCITY

#### Easy Lock™ Replacement Kit

Part Number: 13005000 (4-per Kit)

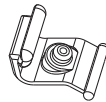

#### Easy Lock™ Replacement Kit

Part Number: 13005000 (4-per Kit)



#### Guard Chain Kit

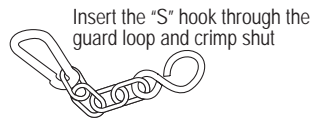

Part Number: 13006500 (2-per Kit)

#### Guard Chain Kit

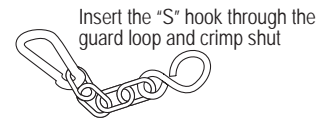

Part Number: 13006500 (2-per Kit)

#### Drivelines

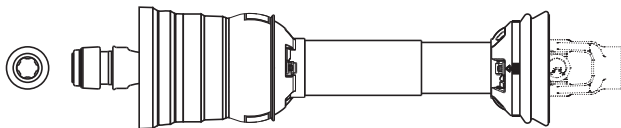

Stock Number		
14501448	No Longer Available In Unequal Arm	Use Part No. 14553848
14501458	Obsolete	
14501467	Obsolete	
14601448	No Longer Available In Unequal Arm	Use Part No. 14653848
14601458	Obsolete	
14601467	Obsolete	

#### Drivelines

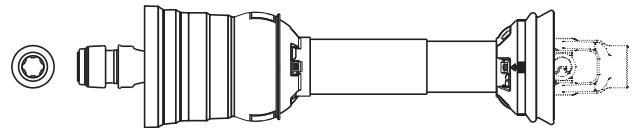

Stock Number	Dim. "A" Overall Com. Length	Max Overall Ext. Length	Tractor Yoke
14553848*	48"	66"	1 3/8" x 6 Spl. AL
14653848*	48"	66"	1 3/8" x 21 Spl. AL

\*(Order implement yoke and cross & bearing kit separately as required)

# NORTH AMERICAN SECTION

## UNEQUAL ARM

### 80° CV Category 4 / 35

## EQUAL ARM

### Tractor Yoke

**Auto-Lok**  
Repair Kit -13004000

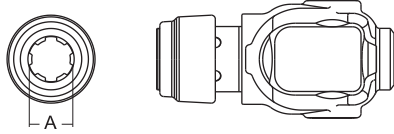

Stock Number	Dim. "A" Bore
113-3506	1 3/8" x 6 Spl.
113-3520	1 3/4" x 20 Spl.
113-3521	1 3/8" x 21 Spl.

### Cross & Bearing Kit

**(R-Kit)**  
(Recommended 8 hr. grease interval)

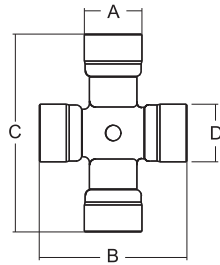

Stock Number	Dim. "A"	Dim. "B"	Dim. "C"	Dim. "D"
200-3540	1 1/8"	3 7/32"	4 1/4"	1 1/4"

### Extended Lubrication

### Cross & Bearing Kit

**(E-Kit)**  
(Recommended 50 hr. grease interval)

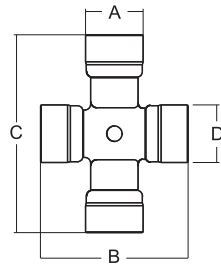

Stock Number	Dim. "A"	Dim. "B"	Dim. "C"	Dim. "D"
201-3540	1 1/8"	3 7/32"	4 1/4"	1 1/4"

### Tractor Yoke

**Auto-Lok**  
Repair Kit -13004000

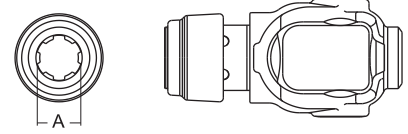

Stock Number	Dim. "A" Bore
111-8606	1 3/8" x 6 Spl.
111-8620	1 3/4" x 20 Spl.
111-8621	1 3/8" x 21 Spl.

### Cross & Bearing Kit

**(R-Kit)**  
(Recommended 8 hr. grease interval)

Bushing Lube  
Located in Cup

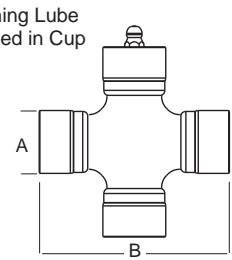

Stock Number	Dim. "A"	Dim. "B"
203-8692	30.22mm (1.19")	92.0mm (3.63")

### Extended Lubrication

### Cross & Bearing Kit

**(E-Kit)**  
(Recommended 50 hr. grease interval)

Bushing Lube  
Located in Cup

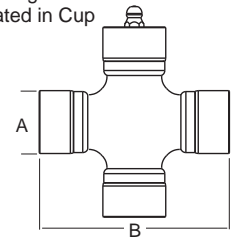

Stock Number	Dim. "A"	Dim. "B"
204-8692	30.22mm (1.19")	92.0mm (3.63")

CONSTANT  
VELOCITY

# NORTH AMERICAN SECTION

## UNEQUAL ARM

### 80° CV Category 4 / 35

## EQUAL ARM

### Center Housing

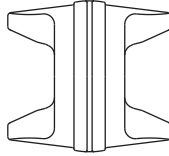

Stock  
Number

550-3540 No Longer Available In Unequal Arm

Order Replacement Joint & Shaft Assembly Part # 15558600 or 15658600 or 15758600

### Yoke & Shaft

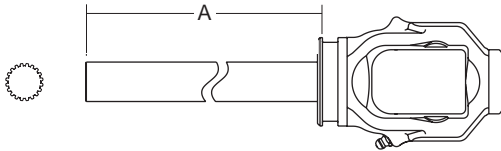

Stock Number	Shaft Size	Major Dim.	Dim. "A" Shaft Length
10103501	1 5/16" x 20 Spl.	1.3801/1.375"	27"

### Yoke, Tube & Sleeve Assembly

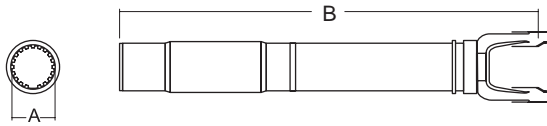

Stock Number	Dim. "A" Bore	Overall Driveline Length	Dim. "B" *CL to end of Sleeve
11113548	1 5/16" x 20 Spl.	48"	32"
11113558	1 5/16" x 20 Spl.	58"	41.63"

\*CL = Centerline

### Joint & Shaft

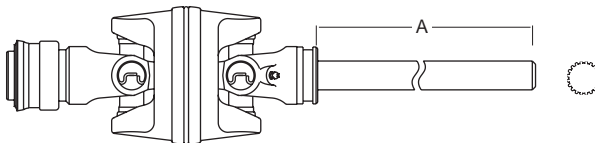

Stock Number	Shaft Size	Use Part No.
15503540	No Longer Available In Unequal Arm	15558600
15603540	No Longer Available In Unequal Arm	15658600
15703540	No Longer Available In Unequal Arm	15758600

### Center Housing

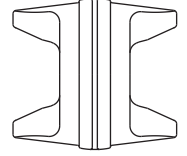

Stock  
Number

515-8600

### Yoke & Shaft

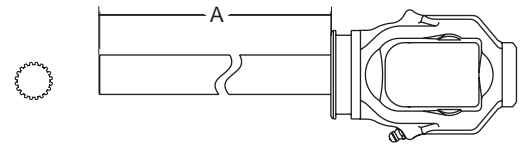

Stock Number	Shaft Size	Major Dim.	Dim. "A" Shaft Length
10108600	1 5/16" x 20 Spl.	1.3801/1.375"	27"

### Yoke, Tube & Sleeve Assembly

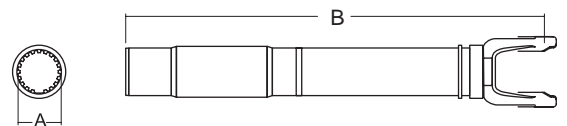

Stock Number	Dim. "A" Bore	Overall Driveline Length	Dim. "B" *CL to end of Sleeve
11113548	1 5/16" x 20 Spl.	48"	32"
11113558	1 5/16" x 20 Spl.	58"	41.63"

\*CL = Centerline

### Joint & Shaft

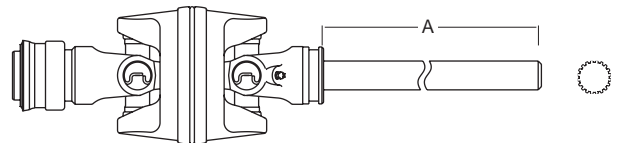

Stock Number	Shaft Size	Dim A Shaft Length	Tractor Yoke
15558600	1 5/16" x 20 Spl.	27"	1 3/8" x 6 Spl.
15658600	1 5/16" x 20 Spl.	27"	1 3/8" x 21 Spl.
15758600	1 5/16" x 20 Spl.	27"	1 3/4" x 20 Spl.

CONSTANT VELOCITY

# NORTH AMERICAN SECTION

## 80° CV Category 4 / 35

### UNEQUAL ARM

### EQUAL ARM

#### Yoke, Tube & Sleeve Assembly w/Guard

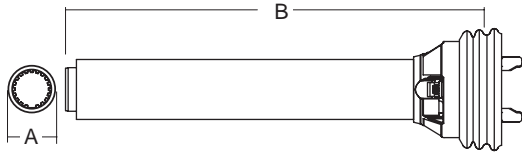

Stock Number	Dim. "A" Bore	Overall Driveline Length	Dim. "B" *CL to end of Sleeve
17513548	1 5/16" x 20 Spl.	48"	32"
17513558	1 5/16" x 20 Spl.	58"	41.63"

\*CL = Centerline

#### Yoke, Tube & Sleeve Assembly w/Guard

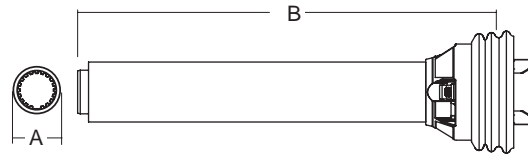

Stock Number	Dim. "A" Bore	Overall Driveline Length	Dim. "B" *CL to end of Sleeve
17513548	1 5/16" x 20 Spl.	48"	32"
17513558	1 5/16" x 20 Spl.	58"	41.63"

\*CL = Centerline

#### Joint & Shaft w/Guard

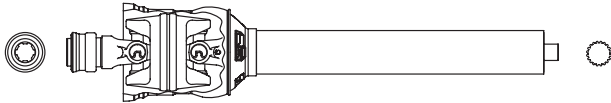

Stock Number	Availability	Use Part No.
19503540	No Longer Available In Unequal Arm	19558600
19603540	No Longer Available In Unequal Arm	19658600
19703540	No Longer Available In Unequal Arm	19758600

#### Joint & Shaft w/Guard

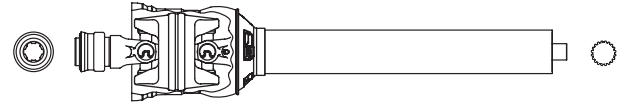

Stock Number	Shaft Size	Shaft Length	Tractor Yoke
19558600	1 5/16" x 20 Spl.	27.5"	1 3/8" x 6 Spl.
19658600	1 5/16" x 20 Spl.	27.5"	1 3/8" x 21 Spl.
19758600	1 5/16" x 20 Spl.	27.5"	1 3/4" x 20 Spl.

CONSTANT VELOCITY

#### Driveline Tractor Tube Half Assembly w/Guard

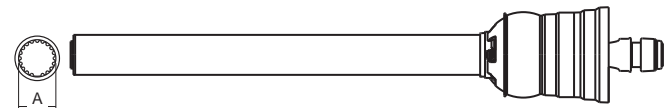

Stock Number	Tractor Yoke	Dim. "A" Bore	Tube Half
92-14558659	1 3/8" x 6 Spl.	1 5/16" x 20 Spl.	2 1/2" OD
92-14658659	1 3/8" x 21 Spl.	1 5/16" x 20 Spl.	2 1/2" OD
92-14758659	1 3/4" x 20 Spl.	1 5/16" x 20 Spl.	2 1/2" OD

**NOTE:** The above three part numbers are provided with CV, tube and slip sleeve assembled. CV TUBE HALF to connect to TRACTOR PTO.

# NORTH AMERICAN SECTION

## 80° CV Category 4 / 35

### UNEQUAL ARM

### EQUAL ARM

#### Guard

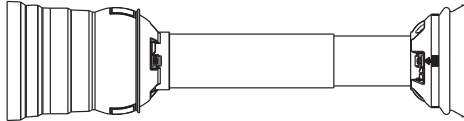

Bearings supplied with Guard

Stock Number	Overall Driveline Length	Bearing Kit (2-Per Kit)
912-1448	48"	921-1400
912-1458	58"	921-1400
912-1467	67"	921-1400

Assembly instructions included with guard bearing kit  
NOTE: Guards must rotate freely on yokes

#### Easy Lock™ Replacement Kit

Part Number: 13005000 (4-per Kit)



#### Guard Chain Kit

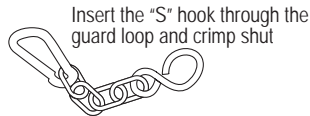

Insert the "S" hook through the guard loop and crimp shut

Part Number: 13006500 (2-per Kit)

#### Drivelines

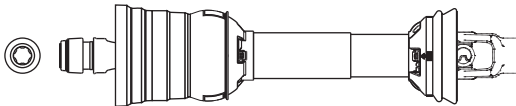

Stock Number	Availability	Notes
14513548	No Longer Available In Unequal Arm	Use Part No. 14558648
14513558	No Longer Available In Unequal Arm	Use Part No. 14558658
14513567	Obsolete	
14613548	No Longer Available In Unequal Arm	Use Part No. 14658648
14613558	No Longer Available In Unequal Arm	Use Part No. 14658658
14613567	Obsolete	
14713548	No Longer Available In Unequal Arm	Use Part No. 14758648
14713558	No Longer Available In Unequal Arm	Use Part No. 14758658
14713567	Obsolete	

#### Guard

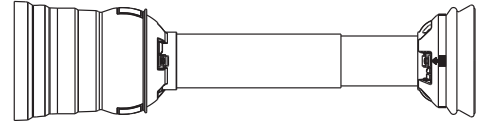

Bearings supplied with Guard

Stock Number	Overall Driveline Length	Bearing Kit (2-Per Kit)
912-1448	48"	921-1400
912-1458	58"	921-1400
912-1467	67"	921-1400

Assembly instructions included with guard bearing kit  
NOTE: Guards must rotate freely on yokes

#### Easy Lock™ Replacement Kit

Part Number: 13005000 (4-per Kit)



#### Guard Chain Kit

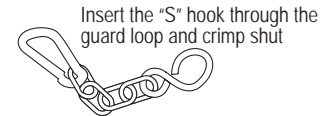

Insert the "S" hook through the guard loop and crimp shut

Part Number: 13006500 (2-per Kit)

#### Drivelines

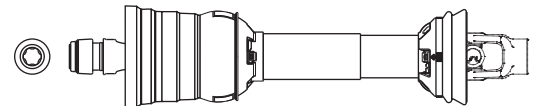

Stock Number	Overall Com. Length	Max Overall Ext. Length	Tractor Yoke
14558648*	48"	69"	1 3/8" x 6 Spl. AL
14558658*	58"	80"	1 3/8" x 6 Spl. AL
14658648*	48"	69"	1 3/8" x 21 Spl. AL
14658658*	58"	80"	1 3/8" x 21 Spl. AL
14758648*	48"	69"	1 3/4" x 20 Spl. AL
14758658*	58"	80"	1 3/4" x 20 Spl. AL

\*(Order implement yoke and cross & bearing kit separately as required)

#### Complete CV Driveline

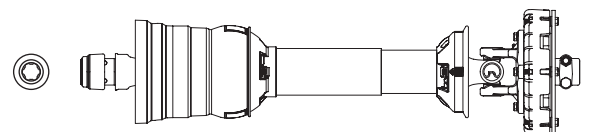

Stock Number	Overall Com. Length	Max Overall Ext. Length	Tractor Yoke	Implement Yoke
14686602	58"	78"	1 3/8"x21 Spl. AL	1 3/8"x21 Spl.w/Fric.Cl.
14586601	58"	78"	1 3/8"x6 Spl. AL	1 3/8"x21 Spl.w/Fric.Cl.

CONSTANT VELOCITY

# NORTH AMERICAN SECTION

## 80° CV Category 5 / 35-44

### UNEQUAL ARM

### EQUAL ARM

#### Tractor Yoke

**Auto-Lok**  
Repair Kit - 13004000

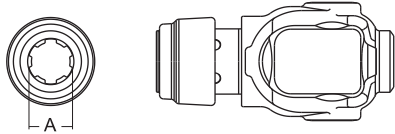

Stock Number	Dim. "A" Bore
111-3506	1 3/8" x 6 Spl.
111-3520	1 3/4" x 20 Spl.
111-3521	1 3/8" x 21 Spl.

#### Cross & Bearing Kit

**(R-Kit)**  
(Recommended 8 hr. grease interval)

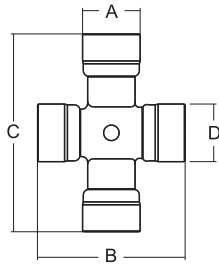

Stock Number	Dim. "A"	Dim. "B"	Dim. "C"	Dim. "D"
200-3545	1 1/4"	3 7/32"	4 5/16"	1 1/4"

#### Extended Lubrication

#### Cross & Bearing Kit

**(E-Kit)**  
(Recommended 50 hr. grease interval)

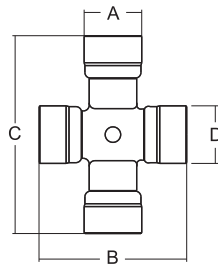

Stock Number	Dim. "A"	Dim. "B"	Dim. "C"	Dim. "D"
201-3545	1 1/4"	3 7/32"	4 5/16"	1 1/4"

#### Shaft

1 11/16 x 20 Spline  
Introduction Hardened



Stock Number	Length	Major Dim.
404-2720	3'	1.790/1.785

#### Tractor Yoke

**Auto-Lok**  
Repair Kit - 13004000

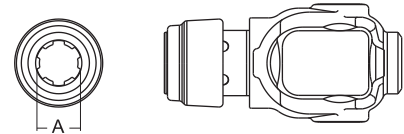

Stock Number	Dim. "A" Bore
111-5806	1 3/8" x 6 Spl.
111-5820	1 3/4" x 20 Spl.
111-5821	1 3/8" x 21 Spl.

#### Cross & Bearing Kit

**(R-Kit)**  
(Recommended 8 hr. grease interval)

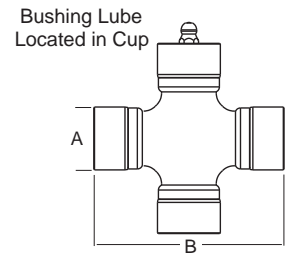

Stock Number	Dim. "A"	Dim. "B"
200-5800	30.22mm (1 3/16")	106.35mm (4 3/16")

#### Extended Lubrication

#### Cross & Bearing Kit

**(E-Kit)**  
(Recommended 50 hr. grease interval)

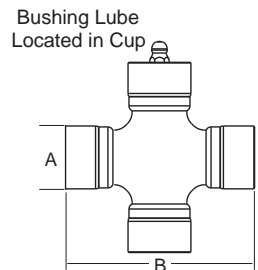

Stock Number	Dim. "A"	Dim. "B"
201-5800	30.22mm (1 3/16")	106.35mm (4 3/16")

#### Shaft

1 11/16 x 20 Spline  
Introduction Hardened



Stock Number	Length	Major Dim.
404-2720	3'	1.790/1.785

CONSTANT  
VELOCITY

# NORTH AMERICAN SECTION

## UNEQUAL ARM

### 80° CV Category 5 / 35-44

## EQUAL ARM

### Center Housing

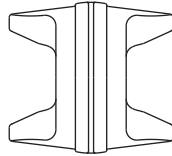

Stock  
Number

550-3545 No Longer Available in Unequal Arm  
Order Replacement Joint & Shaft Assembly Part #15505806 or 15605821 or 15705820

### Yoke & Shaft

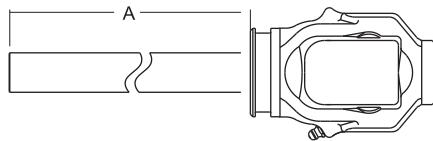

Stock  
Number

10103500 No Longer Available in Unequal Arm  
Order Replacement Joint & Shaft Assembly Part #15505806 or 15605821 or 15705820

### Yoke, Tube & Sleeve Assembly

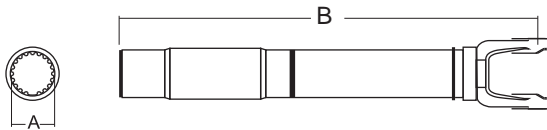

Stock Number	Dim. "A" Bore	Overall Driveline Length	Dim. "B" *CL to end of Sleeve
11103548	1 11/16" x 20 Spl.	48"	29.38"
11103558	1 11/16" x 20 Spl.	58"	39.38"
11103567	1 11/16" x 20 Spl.	67"	48.38"
11103573	1 11/16" x 20 Spl.	73"	54.38"
11103579	1 11/16" x 20 Spl.	79"	60.38"
11104448	1 11/16" x 20 Spl.	48"	28.88"
11104458	1 11/16" x 20 Spl.	58"	38.88"
11104467	1 11/16" x 20 Spl.	67"	47.88"
11104473	1 11/16" x 20 Spl.	73"	53.88"
11104479	1 11/16" x 20 Spl.	79"	59.88"

\*CL = Centerline

### Center Housing

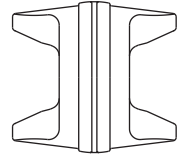

Stock  
Number

515-5800

### Yoke & Shaft

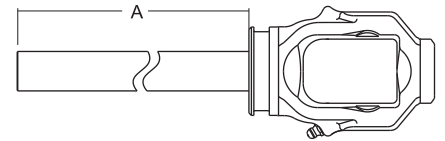

Stock  
Number

Shaft  
Size

Dim. "A"  
Shaft Length

10105800

1 11/16" x 20 Spl.

27"

### Yoke, Tube & Sleeve Assembly

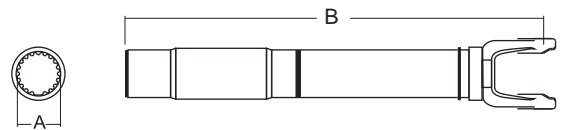

Stock Number	Dim. "A" Bore	Overall Driveline Length	Dim. "B" *CL to end of Sleeve
11103548	1 11/16" x 20 Spl.	48"	29.38"
11103558	1 11/16" x 20 Spl.	58"	39.38"
11103567	1 11/16" x 20 Spl.	67"	48.38"
11103573	1 11/16" x 20 Spl.	73"	54.38"
11103579	1 11/16" x 20 Spl.	79"	60.38"
11104448	1 11/16" x 20 Spl.	48"	28.88"
11104458	1 11/16" x 20 Spl.	58"	38.88"
11104467	1 11/16" x 20 Spl.	67"	47.88"
11104473	1 11/16" x 20 Spl.	73"	53.88"
11104479	1 11/16" x 20 Spl.	79"	59.88"

\*CL = Centerline

CONSTANT  
VELOCITY

# NORTH AMERICAN SECTION

## UNEQUAL ARM

### 80° CV Category 5 / 35-44

## EQUAL ARM

#### Joint & Shaft

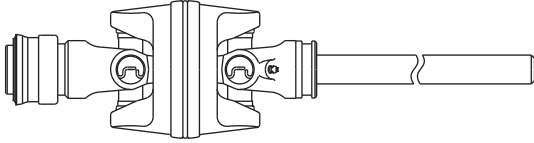

Stock Number	Description	Use Part No.
15503506	No Longer Available In Unequal Arm	15505806
15603521	No Longer Available In Unequal Arm	15605821
15703520	No Longer Available In Unequal Arm	15705820

#### Joint & Shaft

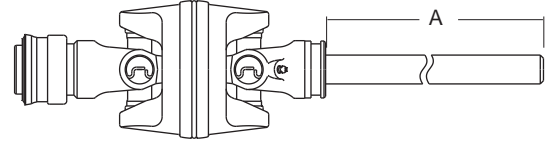

Stock Number	Shaft Size	Dim. "A" Shaft Length	Tractor Yoke
15505806	1 11/16" x 20 Spl.	27"	1 3/8" x 6 Spl.
15605821	1 11/16" x 20 Spl.	27"	1 3/8" x 21 Spl.
15705820	1 11/16" x 20 Spl.	27"	1 3/4" x 20 Spl.

#### Yoke, Tube & Sleeve Assembly w/Guard

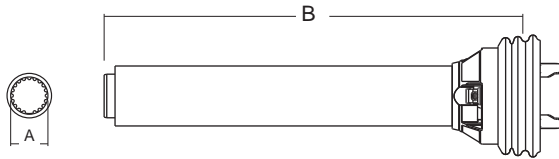

Stock Number	Dim. "A" Bore	Overall Driveline Length	Dim. "B" *CL to end of Sleeve
17503548	1 11/16" x 20 Spl.	48"	29.38"
17503558	1 11/16" x 20 Spl.	58"	39.38"
17503567	1 11/16" x 20 Spl.	67"	48.38"
17503573	1 11/16" x 20 Spl.	73"	54.38"
17053579	1 11/16" x 20 Spl.	79"	60.38"
17504448	1 11/16" x 20 Spl.	48"	28.88"
17504458	1 11/16" x 20 Spl.	58"	38.88"
17504467	1 11/16" x 20 Spl.	67"	47.88"
17504473	1 11/16" x 20 Spl.	73"	53.88"
17504479	1 11/16" x 20 Spl.	79"	59.87"

\*CL = Centerline

#### Joint & Shaft w/Guard

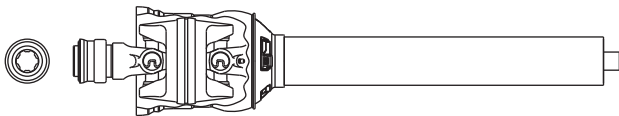

Stock Number	Description	Use Part No.
19503506	No Longer Available In Unequal Arm	19505806
19603521	No Longer Available In Unequal Arm	19605821
19703520	No Longer Available In Unequal Arm	19705820

#### Yoke, Tube & Sleeve Assembly w/Guard

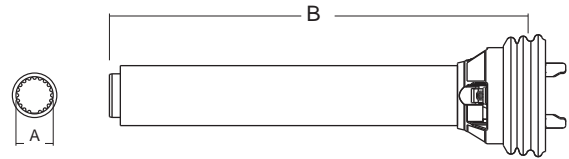

Stock Number	Dim. "A" Bore	Overall Driveline Length	Dim. "B" *CL to end of Sleeve
17503548	1 11/16" x 20 Spl.	48"	29.38"
17503558	1 11/16" x 20 Spl.	58"	39.38"
17503567	1 11/16" x 20 Spl.	67"	48.38"
17503573	1 11/16" x 20 Spl.	73"	54.38"
17053579	1 11/16" x 20 Spl.	79"	60.38"
17504448	1 11/16" x 20 Spl.	48"	28.88"
17504458	1 11/16" x 20 Spl.	58"	38.88"
17504467	1 11/16" x 20 Spl.	67"	47.88"
17504473	1 11/16" x 20 Spl.	73"	53.88"
17504479	1 11/16" x 20 Spl.	79"	59.87"

\*CL = Centerline

#### Joint & Shaft w/Guard

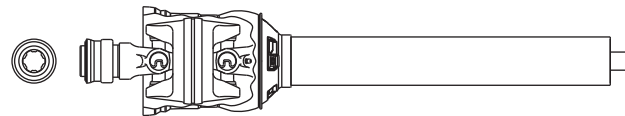

Stock Number	Shaft Size	Shaft Length	Tractor Yoke
19505806	1 11/16" x 20 Spl.	27"	1 3/8" x 6 Spl.
19605821	1 11/16" x 20 Spl.	27"	1 3/8" x 21 Spl.
19705820	1 11/16" x 20 Spl.	27"	1 3/4" x 20 Spl.

CONSTANT VELOCITY



# NORTH AMERICAN SECTION

## 80° CV Category 5 / 35-44

### UNEQUAL ARM

### EQUAL ARM

#### Driveline Tractor Tube Half Assembly w/Guard



Stock Number	Tractor Yoke	Dim. "A" Bore	Tube Half
92-14503559	No Longer Available In Unequal Arm	Use Part No. 92-14505859	
92-14603559	No Longer Available In Unequal Arm	Use Part No. 92-14605859	

#### Driveline Tractor Tube Half Assembly w/Guard

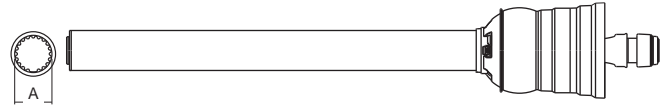

Stock Number	Tractor Yoke	Dim. "A" Bore	Tube Half
92-14505859	1 3/8" x 6 Spl.	1 11/16" x 20 Spl.	2 1/2" OD
92-14605859	1 3/8" x 21 Spl.	1 11/16" x 20 Spl.	2 1/2" OD

NOTE: The above two part numbers are provided with CV, tube and slip sleeve assembled. CV TUBE HALF to connect to TRACTOR PTO.

#### Guard

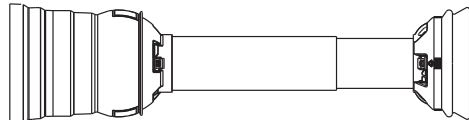

Bearings supplied with Guard

Stock Number	Overall Driveline Length	Bearing Kit (2-per kit)
912-3548	48"	921-3500
912-3558	58"	921-3500
912-3567	67"	921-3500
912-3573	73"	921-3500
912-3579	79"	921-3500

Assembly instructions included with guard bearing kit

NOTE: Guards must rotate freely on yokes

#### Guard

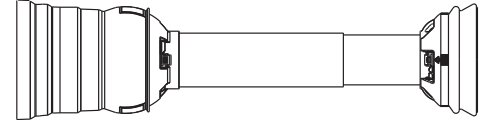

Bearings supplied with Guard

Stock Number	Overall Driveline Length	Bearing Kit (2-per kit)
912-3548	48"	921-3500
912-3558	58"	921-3500
912-3567	67"	921-3500
912-3573	73"	921-3500
912-3579	79"	921-3500

Assembly instructions included with guard bearing kit

NOTE: Guards must rotate freely on yokes

#### Easy Lock™ Replacement Kit

Part Number: 13005000 (4-per Kit)



#### Easy Lock™ Replacement Kit

Part Number: 13005000 (4-per Kit)



#### Guard Chain Kit

Insert the "S" hook through the guard loop and crimp shut

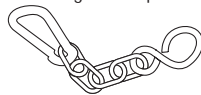

Part Number: 13006500 (2-per Kit)

#### Guard Chain Kit

Insert the "S" hook through the guard loop and crimp shut



Part Number: 13006500 (2-per Kit)

CONSTANT VELOCITY

# NORTH AMERICAN SECTION

## 80° CV Category 5 / 35-44

### UNEQUAL ARM

Stock Number		Drivelines
14503500	No Longer Available In Unequal Arm	Use Part No. 14505800
14503501	No Longer Available In Unequal Arm	Use Part No. 14505801
14503502	No Longer Available In Unequal Arm	Use Part No. 14505802
14503548	No Longer Available In Unequal Arm	Use Part No. 14505848
14503558	No Longer Available In Unequal Arm	Use Part No. 14505858
14503567	No Longer Available In Unequal Arm	Use Part No. 14505867
14503573	OBSOLETE	
14503579	OBSOLETE	
14504448	No Longer Available In Unequal Arm	Use Part No. 14545848
14504458	No Longer Available In Unequal Arm	Use Part No. 14545858
14504467	No Longer Available In Unequal Arm	Use Part No. 14545867
14504473	No Longer Available In Unequal Arm	Use Part No. 14545873
14504479	No Longer Available In Unequal Arm	Use Part No. 14545879
14603500	No Longer Available In Unequal Arm	Use Part No. 14605800
14603548	No Longer Available In Unequal Arm	Use Part No. 14605848
14603558	No Longer Available In Unequal Arm	Use Part No. 14605858
14603567	No Longer Available In Unequal Arm	Use Part No. 14605867
14603573	OBSOLETE	
14603579	OBSOLETE	
14604448	No Longer Available In Unequal Arm	Use Part No. 14645848
14604458	No Longer Available In Unequal Arm	Use Part No. 14645858
14604467	No Longer Available In Unequal Arm	Use Part No. 14645867
14604473	OBSOLETE	
14604479	OBSOLETE	
14703548	No Longer Available In Unequal Arm	Use Part No. 14705848
14703558	No Longer Available In Unequal Arm	Use Part No. 14705858
14703567	No Longer Available In Unequal Arm	Use Part No. 14705867
14703573	OBSOLETE	
14703579	OBSOLETE	
14704448	No Longer Available In Unequal Arm	Use Part No. 14745848
14704458	No Longer Available In Unequal Arm	Use Part No. 14745858
14704467	No Longer Available In Unequal Arm	Use Part No. 14745867
14704473	OBSOLETE	
14704479	OBSOLETE	

### EQUAL ARM

Stock Number	Shaft Size	Overall Compressed Length	Maximum Overall		Tractor Yoke	Implement Yoke	Category
			Extended Operating Length	Operating Length			
14505800	1 11/16" x 20 Spl.	58"	79"		1 3/8" x 6 Spl.	1 3/8" x 20 Spl. w/Friction Cl.	5/35
14505801	1 11/16" x 20 Spl.	67"	88"		1 3/8" x 6 Spl.	1 3/8" x 21 Spl. w/Friction Cl.	5/35
14505802	1 11/16" x 20 Spl.	58"	79"		1 3/8" x 6 Spl.	1 3/8" x 6 Spl. w/Friction Cl	5/35
14505848	1 11/16" x 20 Spl.	48"	67"		1 3/8" x 6 Spl. *		5/35
14505858	1 11/16" x 20 Spl.	58"	77"		1 3/8" x 6 Spl. *		5/35
14505867	1 11/16" x 20 Spl.	67"	84"		1 3/8" x 6 Spl.		5/35
14545848	1 11/16" x 20 Spl.	48"	67"		1 3/8" x 6 Spl. *		5/44
14545858	1 11/16" x 20 Spl.	58"	77"		1 3/8" x 6 Spl. *		5/44
14545867	1 11/16" x 20 Spl.	67"	84"		1 3/8" x 6 Spl. *		5/44
14545873	1 11/16" x 20 Spl.	73"	92"		1 3/8" x 6 Spl. *		5/44
14545879	1 11/16" x 20 Spl.	79"	96"		1 3/8" x 6 Spl. *		5/44
14605800	1 11/16" x 20 Spl.	58"	79"		1 3/8" x 21 Spl.	1 3/8" x 6 Spl. w/Friction Clutch	5/35
14605848	1 11/16" x 20 Spl.	48"	67"		1 3/8" x 21 Spl. *		5/35
14605858	1 11/16" x 20 Spl.	58"	77"		1 3/8" x 21 Spl. *		5/35
14605867	1 11/16" x 20 Spl.	67"	84"		1 3/8" x 21 Spl. *		5/35
14645848	1 11/16" x 20 Spl.	48"	67"		1 3/8" x 21 Spl. *		5/44
14645858	1 11/16" x 20 Spl.	58"	77"		1 3/8" x 21 Spl. *		5/44
14645867	1 11/16" x 20 Spl.	67"	84"		1 3/8" x 21 Spl. *		5/44
14705848	1 11/16" x 20 Spl.	48"	67"		1 3/4" x 20 Spl. *		5/35
14705858	1 11/16" x 20 Spl.	58"	77"		1 3/4" x 20 Spl. *		5/35
14705867	1 11/16" x 20 Spl.	67"	84"		1 3/4" x 20 Spl. *		5/35
14745848	1 11/16" x 20 Spl.	48"	67"		1 3/4" x 20 Spl. *		5/44
14745858	1 11/16" x 20 Spl.	58"	77"		1 3/4" x 20 Spl. *		5/44
14745867	1 11/16" x 20 Spl.	67"	84"		1 3/4" x 20 Spl.		5/44

CONSTANT  
VELOCITY

# NORTH AMERICAN SECTION

## 80° CV Category 6 / 55

### UNEQUAL ARM

### EQUAL ARM

#### Tractor Yoke

##### Auto-Lok

Repair Kit - 13004000\*  
13004020\*\*

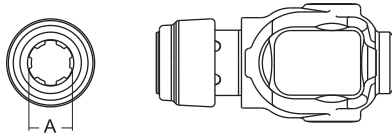

##### Stock

Number	Dim. "A" Bore
111-5506*	1 3/8" x 6 Spl.
111-5520**	1 3/4" x 20 Spl.
111-5521*	1 3/8" x 21 Spl.

#### Cross & Bearing Kit

##### (R-Kit)

(Recommended 8 hr. grease interval)

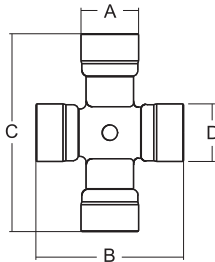

##### Stock

Number	Dim. "A"	Dim. "B"	Dim. "C"	Dim. "D"
200-5556	1 5/16"	3 23/32"	4 5/16"	1 17/32"

#### Shaft

1 11/16 x 20 Spline  
Introduction hadrened



##### Stock

Number	Length	Major Dim.
404-2720	3'	1.790/1.785

#### Tractor Yoke

##### Auto-Lok

Repair Kit - 13004000

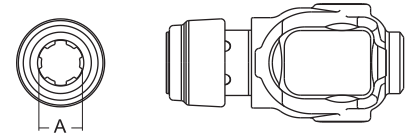

##### Stock

Number	Dim. "A" Bore
111-6806	1 3/8" x 6 Spl.
111-6820	1 3/4" x 20 Spl.
111-6821	1 3/8" x 21 Spl.

#### Cross & Bearing Kit

##### (R-Kit)

(Recommended 8 hr. grease interval)

Bushing Lube  
Located in Cup

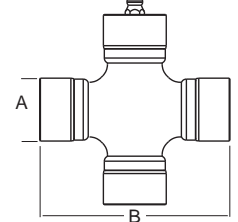

##### Stock

Number	Dim. "A"	Dim. "B"
203-6806	34.94 mm (1 3/8")	106.5 mm (4 3/16")

#### Extended Lubrication Cross & Bearing Kit

##### (E-Kit)

(Recommended 50 hr. grease interval)

Bushing Lube  
Located in Cup

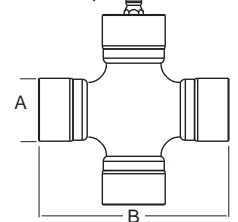

##### Stock

Number	Dim. "A"	Dim. "B"
204-6806	34.94 mm (1 3/8")	106.5 mm (4 3/16")

#### Shaft

1 11/16 x 20 Spline  
Introduction hadrened



##### Stock

Number	Length	Major Dim.
404-2720	3'	1.790/1.785

CONSTANT  
VELOCITY

# NORTH AMERICAN SECTION

## 80° CV Category 6 / 55

### UNEQUAL ARM

### EQUAL ARM

#### Center Housing

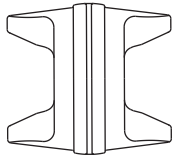

Stock  
Number

550-5556 No Longer Available in Unequal Arm  
Order Replacement Joint & Shaft Assembly Part No. 15556800 or 15756800

#### Yoke & Shaft

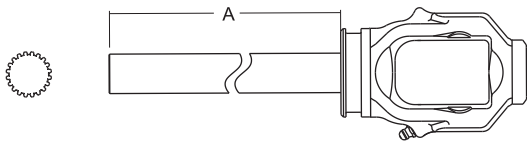

Stock  
Number

10105500 No Longer Available in Unequal Arm  
Order Replacement Joint & Shaft Assembly Part No. 15556800 or 15656800 or 15756800

#### Yoke, Tube & Sleeve Assembly

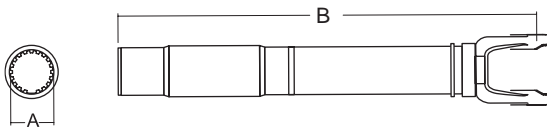

Stock Number	Dim. "A" Bore	Overall Driveline Length	Dim. "B" *CL to end of Sleeve
11105548	1 11/16" x 20 Spl.	48"	29.38"
11105558	1 11/16" x 20 Spl.	58"	38.88"
11105567	1 11/16" x 20 Spl.	67"	47.88"
11105573	1 11/16" x 20 Spl.	73"	53.88"
11105579	1 11/16" x 20 Spl.	79"	59.88"

\*CL = Centerline

#### Joint & Shaft

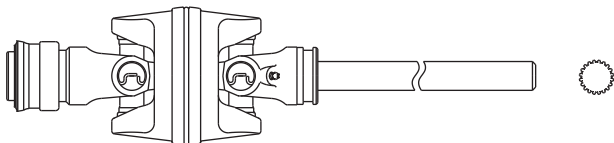

Stock  
Number

15505506 No Longer Available In Unequal Arm Use Part No. 15556800  
15605521 No Longer Available In Unequal Arm Use Part No. 15656800  
15755520 No Longer Available In Unequal Arm Use Part No. 15756800

#### Center Housing

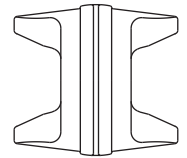

Stock  
Number

515-6800

#### Yoke & Shaft

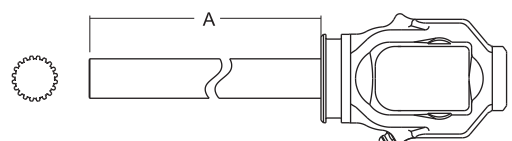

Stock Number	Shaft Size	Dim. "A" Shaft Length
10106800	1 11/16" x 20 Spl.	27"
10106801	1 11/16" x 20 Spl.	30"

#### Yoke, Tube & Sleeve Assembly

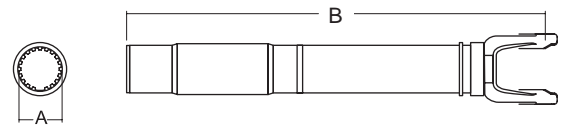

Stock Number	Dim. "A" Bore	Overall Driveline Length	Dim. "B" *CL to end of Sleeve
11105548	1 11/16" x 20 Spl.	48"	29.38"
11105558	1 11/16" x 20 Spl.	58"	38.88"
11105567	1 11/16" x 20 Spl.	67"	47.88"
11105573	1 11/16" x 20 Spl.	73"	53.88"
11105579	1 11/16" x 20 Spl.	79"	59.88"

\*CL = Centerline

#### Joint & Shaft

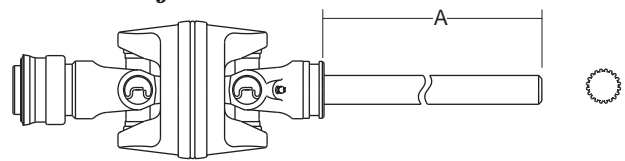

Stock Number	Shaft Size	Dim "A" Shaft Length	Tractor Yoke
15556800	1 11/16" x 20 Spl.	27"	1 3/8" x 6 Spl.
15656800	1 11/16" x 20 Spl.	27"	1 3/8" x 21 Spl.
15756800	1 11/16" x 20 Spl.	27"	1 3/4" x 20 Spl.

CONSTANT  
VELOCITY

# NORTH AMERICAN SECTION

## 80° CV Category 6 / 55

### UNEQUAL ARM

### EQUAL ARM

#### Yoke, Tube & Sleeve Assembly w/Guard

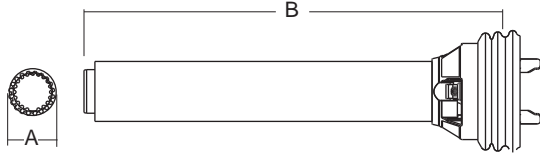

Stock Number	Dim. "A" Bore	Overall Driveline Length	Dim. "B" *CL to end of Sleeve	Implement Yoke
17505548	1 11/16" x 20 Spl.	48"	28.88"	**
17505558	1 11/16" x 20 Spl.	58"	38.88"	**
17505567	1 11/16" x 20 Spl.	67"	47.88"	**
17505573	1 11/16" x 20 Spl.	73"	53.88"	**
17505579	1 11/16" x 20 Spl.	79"	59.88"	**
92-14505551	1 11/16" x 20 Spl.	51"	30.75"	1 3/4" x 20 Spl.
92-14505555	1 11/16" x 20 Spl.	55"	30.75"	1 3/8" x 6 Spl.
92-14515555	1 11/16" x 20 Spl.	55"	30.75"	1 3/4" x 20 Spl.

\*CL = Centerline

\*\* (Order implement yoke and cross & bearing kit separately as required)

#### Joint & Shaft w/Guard

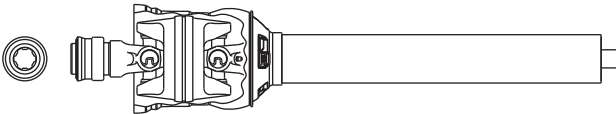

Stock Number	Notes	Part No.
19505506	No Longer Available In Unequal Arm	Use Part No. 19556800
19605521	No Longer Available In Unequal Arm	Use Part No. 19656800
19705520	No Longer Available In Unequal Arm	Use Part No. 19756800
93-14505555	No Longer Available In Unequal Arm	Use Part No. 93-14556855
93-14605555	No Longer Available In Unequal Arm	Use Part No. 93-14656855
93-14705555	No Longer Available In Unequal Arm	Use Part No. 93-14756855

#### Yoke, Tube & Sleeve Assembly w/Guard

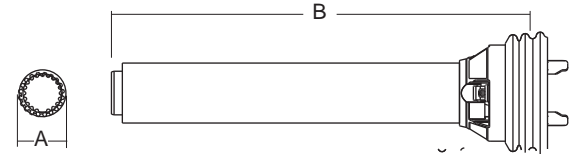

Stock Number	Dim. "A" Bore	Overall Driveline Length	Dim. "B" *CL to end of Sleeve	Implement Yoke
17505548	1 11/16" x 20 Spl.	48"	28.88"	**
17505558	1 11/16" x 20 Spl.	58"	38.88"	**
17505567	1 11/16" x 20 Spl.	67"	47.88"	**
17505573	1 11/16" x 20 Spl.	73"	53.88"	**
17505579	1 11/16" x 20 Spl.	79"	59.88"	**
92-14505551	1 11/16" x 20 Spl.	51"	30.75"	1 3/4" x 20 Spl.
92-14505555	1 11/16" x 20 Spl.	55"	34"	1 3/8" x 6 Spl.
92-14515555	1 11/16" x 20 Spl.	55"	34"	1 3/4" x 20 Spl.

\*CL = Centerline

\*\* (Order implement yoke and cross & bearing kit separately as required)

#### Joint & Shaft w/Guard

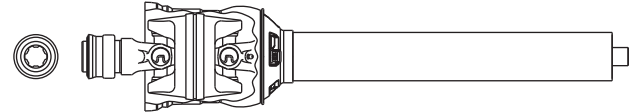

Stock Number	Shaft Size	Shaft Length	Tractor Yoke
19556800	1 11/16" x 20 Spl.	27.5"	1 3/8" x 6 Spl.
19656800	1 11/16" x 20 Spl.	27.5"	1 3/8" x 21 Spl.
19756800	1 11/16" x 20 Spl.	27.5"	1 3/4" x 20 Spl.
93-14556855	1 11/16" x 20 Spl.	30.63"	1 3/8" x 6 Spl"
93-14656855	1 11/16" x 20 Spl.	30.63"	1 3/8" x 21 Spl.
93-14756855	1 11/16" x 20 Spl.	30.63"	1 3/4" x 20 Spl.

CONSTANT VELOCITY

# NORTH AMERICAN SECTION

## 80° CV Category 6 / 55

### UNEQUAL ARM

### EQUAL ARM

#### Guard



Bearings supplied with Guard

Stock Number	Overall Driveline Length	Bearing Kit (2-per kit)
912-5548	48"	921-4400
912-5558	58"	921-4400
912-5567	67"	921-4400
912-5573	73"	921-4400
912-5579	79"	921-4400

Assembly instructions included with guard bearing kit  
NOTE: Guards must rotate freely on yokes

#### Easy Lock™ Replacement Kit

Part Number: 13005000 (4-per Kit)



#### Guard

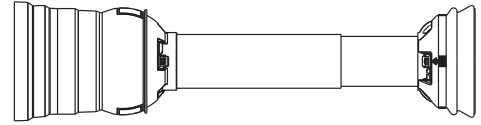

Bearings supplied with Guard

Stock Number	Overall Driveline Length	Bearing Kit (2-per kit)
912-5548	48"	921-4400
912-5555	55"	921-4400
912-5558	58"	921-4400
912-5567	67"	921-4400
912-5573	73"	921-4400
912-5579	79"	921-4400

Assembly instructions included with guard bearing kit  
NOTE: Guards must rotate freely on yokes

#### Easy Lock™ Replacement Kit

Part Number: 13005000 (4-per Kit)



#### Guard Chain Kit

Insert the "S" hook through the guard loop and crimp shut

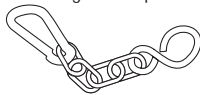

Part Number: 13006500 (2-per Kit)

#### Guard Chain Kit

Insert the "S" hook through the guard loop and crimp shut

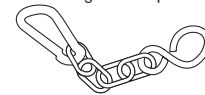

Part Number: 13006500 (2-per Kit)

CONSTANT  
VELOCITY

# NORTH AMERICAN SECTION

## 80° CV Category 6 / 55

### UNEQUAL ARM

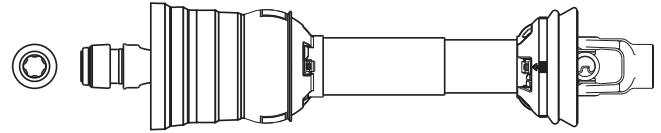

Stock  
Number

14505548	No Longer Available In Unequal Arm	Use Part No. 14556848
14505551	No Longer Available In Unequal Arm	Use Part No. 14556851
14505555	No Longer Available In Unequal Arm	Use Part No. 14556855
14505558	No Longer Available In Unequal Arm	Use Part No. 14556858
14505567	No Longer Available In Unequal Arm	Use Part No. 14556867
14505573	OBSOLETE	
14505579	OBSOLETE	
14515555	No Longer Available In Unequal Arm	Use Part No. 14566855
14605548	No Longer Available In Unequal Arm	Use Part No. 14656848
14605551	No Longer Available In Unequal Arm	Use Part No. 14656851
14605555	No Longer Available In Unequal Arm	Use Part No. 14656855
14605558	No Longer Available In Unequal Arm	Use Part No. 14656858
14605567	No Longer Available In Unequal Arm	Use Part No. 14656867
14605573	OBSOLETE	
14605579	OBSOLETE	
14615555	No Longer Available In Unequal Arm	Use Part No. 14666855
14625555	OBSOLETE	
14635555	OBSOLETE	
14705548	No Longer Available In Unequal Arm	Use Part No. 14756848
14705551	No Longer Available In Unequal Arm	Use Part No. 14756851
14705555	No Longer Available In Unequal Arm	Use Part No. 14756855
14705558	No Longer Available In Unequal Arm	Use Part No. 14756858
14705567	No Longer Available In Unequal Arm	Use Part No. 14756867
14705573	OBSOLETE	
14705579	OBSOLETE	
14715555	No Longer Available In Unequal Arm	Use Part No. 14766855
14725555	OBSOLETE	
14735555	OBSOLETE	

### EQUAL ARM

Stock Number	Shaft Size	Overall Compressed Length	Maximum Overall Extended Operating		Implement Yoke	
			Length	Tractor Yoke		
14556848	1 11/16" x 20 Spl.	48"	70.63"	1 3/8" x 6 Spl. AL	*	
14556851	1 11/16" x 20 Spl.	51"	68"	1 3/8" x 6 Spl. AL	1 3/4" x 20 Spl. Clamp	
14556855	1 11/16" x 20 Spl.	55"	78.75"	1 3/8" x 6 Spl. AL	1 3/8" x 6 Spl. Clamp	
14556858	1 11/16" x 20 Spl.	58"	77.79"	1 3/8" x 6 Spl. AL	*	
14556867	1 11/16" x 20 Spl.	67"	86.79"	1 3/8" x 6 Spl. AL	*	
14566855	1 11/16" x 20 Spl.	55"	78.75"	1 3/8" x 6 Spl. AL	1 3/4" x 20 Spl. Clamp	
14656848	1 11/16" x 20 Spl.	48"	70.63"	1 3/8" x 21 Spl. AL	*	
14656851	1 11/16" x 20 Spl.	51"	68"	1 3/8" x 21 Spl. AL	1 3/4" x 20 Spl. Clamp	
14656855	1 11/16" x 20 Spl.	55"	78.75"	1 3/8" x 21 Spl. AL	1 38" x 6 Spl. Clamp	
14656858	1 11/16" x 20 Spl.	58"	77.79"	1 3/8" x 21 Spl. AL	*	
14656867	1 11/16" x 20 Spl.	67"	86.79"	1 3/8" x 21 Spl. AL	*	
14666855	1 11/16" x 20 Spl.	55"	78.75"	1 3/8" x 21 Spl. AL	1 3/4" x 20 Spl. Clamp	
14756848	1 11/16" x 20 Spl.	48"	70.63"	1 3/4" x 20 Spl. AL	*	
14756851	1 11/16" x 20 Spl.	51"	68"	1 3/4" x 20 Spl. AL	1 3/4" x 20 Spl. Clamp	
14756855	1 11/16" x 20 Spl.	55"	78.75"	1 3/4" x 20 Spl. AL	1 3/8" x 6 Spl. Clamp	
14756858	1 11/16" x 20 Spl.	58"	77.79"	1 3/4" x 20 Spl. AL	*	
14756867	1 11/16" x 20 Spl.	67"	86.79"	1 3/4" x 20 Spl. AL	*	
14766855	1 11/16" x 20 Spl.	55"	78.75"	1 3/4" x 20 Spl. AL	1 3/4" x 20 Spl. Clamp	

\*(Order implement yoke and cross and bearing kit separately as required)

# NORTH AMERICAN SECTION

## 80° CV Category 6 / 55

### EQUAL ARM

#### Driveline Tractor CV Shaft Half Assembly

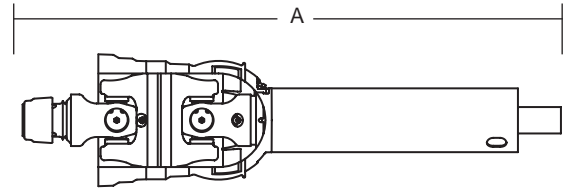

Stock Number	Shaft Size	Dim. "A" Overall Length	Tractor Yoke
83-14656849	1 11/16" x 20 Spl.	37.16"	1 3/8" x 21 Spl.
83-14656853	1 11/16" x 20 Spl.	40.03"	1 3/8" x 21 Spl.
83-14756853	1 11/16" x 20 Spl.	40.03"	1 3/4" x 20 Spl.

#### Driveline Machine CV Tube Half Assembly

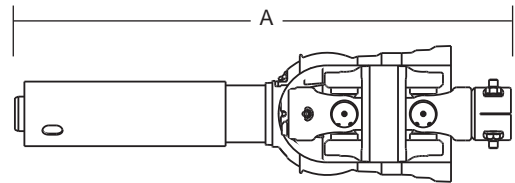

Stock Number	Tube Size	Dim. "A" Overall Length	Tractor Yoke
82-14656849	2 1/2" OD	33.69"	1 1/2" Rd. w/3/8" Keyway
82-14656853	2 1/2" OD	37.44"	1 1/2" x 23 Spl. Clamp

#### Direct Replacement Double CV Driveline

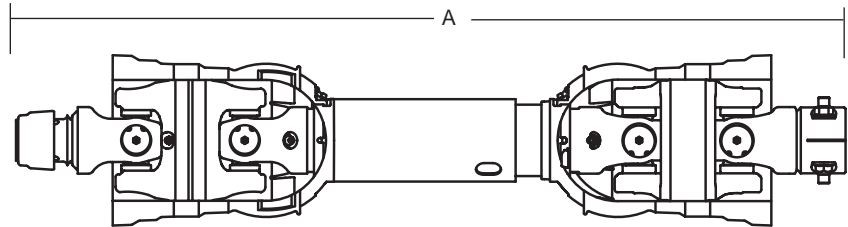

Stock Number	Shaft Size	Dim. "A" Overall Compressed Length	Maximum Overall Extended Operating Length	Tractor Yoke	Implement Yoke
14656849	1 11/16" x 20 Spl.	49"	68.84"	1 3/8" x 21 Spl.	1 1/2" Rd. w/3/8" Keyway
14656853	1 11/16" x 20 Spl.	53"	72.57"	1 3/8" x 21 Spl.	1 1/2 x 23 Spl. Clamp
14756853	1 11/16" x 20 Spl.	53"	72.57"	1 3/4" x 20 Spl.	1 1/2 x 23 Spl. Clamp

CONSTANT  
VELOCITY



# NORTH AMERICAN SECTION

## 50° Constant Velocity Components

### Tractor Yoke

Repair Kit -  
\* 13003100  
\*\* 13004000  
\*\*\* 13004020

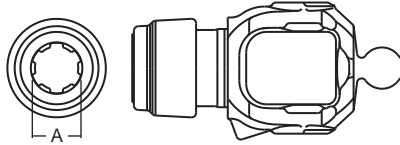

Stock Number	Series	Dim. "A" Bore
150-1406*	14	1 3/8" x 6 Spl.
150-1421*	14	1 3/8" x 21 Spl.
151-3506**	35	1 3/8" x 6 Spl.
151-3520***	35	1 3/4" x 20 Spl.
151-3521**	35	1 3/8" x 21 Spl.
151-5506**	55	1 3/8" x 6 Spl.
151-5521**	55	1 3/8" x 21 Spl.
151-5520***	55	1 3/4" x 20 Spl.

### Cross & Bearing Kit

(R-Kit)  
(Recommended 8 hr. grease interval)

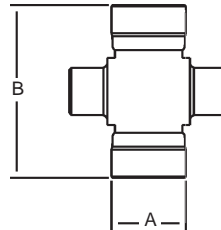

Snap Ring Located in Yoke

Stock Number	Dim. A	Dim. B
200-1400	1 1/8"	2 5/8"
200-3500	1 1/4"	3 7/3
200-5500	1 17/32"	4 5/16"

### Extended Lubrication

### Cross & Bearing Kit

(E-Kit)  
(Recommended 50 hr. grease interval)

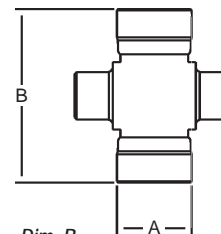

Snap Ring Located in Yoke

Stock Number	Dim. A	Dim. B
201-1400	1 1/8"	2 5/8"
201-3500	1 1/4"	3 7/3
201-5500	1 17/32"	4 5/16"

### Shaft Weld Yoke

(Guard must rotate freely on the yoke)



Stock Number	Series	Dim. "A" Bore
350-1400	14	1" Rd.
350-3500	14	1" Rd.
350-5500	55	1.30" Rd.

### Center Housing

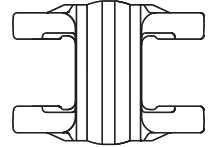

Stock Number	Series
555-1400	14
555-3500	35
555-5500	55

### Tube Yoke

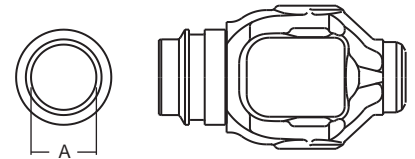

Must use nylon bearing 04-15155  
(Guard must rotate freely on yoke)

Stock Number	Series	
750-3500	35	(fits tube 602-3500)
750-5500	55	(fits tube 602-4400)

### Implement Yoke

Round Bore  
with keyway and pinhole

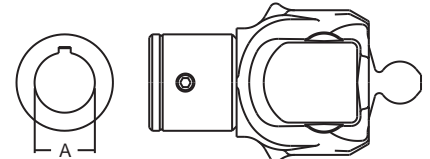

Stock Number	Series	Dim. "A" Bore
850-1420	14 (w/1/4" keyway & 2 set screws)	1 1/4"
851-1420	14 (w/1/4" keyway & 1/4" pinhole)	1 1/4"
850-1422	14 (w/5/16" keyway & 1/4" pinhole)	1 3/8"
850-3520	35 (w/1/4" keyway & pinhole)	1 1/4"
850-3522	35 (w/5/16" keyway & 1/4" pinhole)	1 3/8"
850-3524	35 (w/3/8" keyway & pinhole)	1 1/2"
850-3528	35 (w/3/8" keyway & pinhole)	1 3/4"
850-5522	55 (w/5/16" keyway & .250 pinhole)	1 3/8"
850-5524	55 (w/3/8" keyway)	1 1/2"
850-5528	55 (w/3/8" keyway & .401 pinhole)	1 3/4"

### Applications of 50° CV

Grain Augers	Mower Conditioners
Compost Turners	Potato Harvesters
Front-Mount Riding Mowers	Tube Grinders

# NORTH AMERICAN SECTION

## 50° Constant Velocity Components

### Clamp Yoke

With Keyway

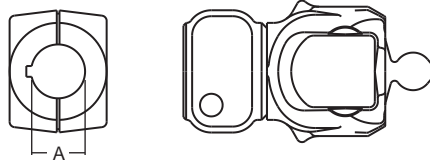

Stock Number	Series	Dim. "A" Bore
857-1420	14 (w/1/4" Keyway)	1 1/4"
857-3506	35	1 3/8" 6 Spl. Clamp
857-3520	35 (w/1/4" Keyway)	1 1/4"
857-3521	35	1 3/8" 6 Spl. Clamp
857-3524	35 (w/3/8" Keyway)	1 1/2"
857-5506	55	1 3/8" x 6 Spl.
857-5520	55	1 3/4" x 20 Spl.
857-5521	55	1 3/8" x 21 Spl.
857-5523	55	1 1/2" x 23 Spl.

### Stock Bore

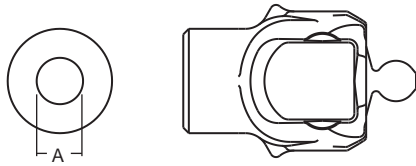

Stock Number	Series	Dim. "A" Bore
859-1400	14	1"
859-3500	35	1"

### Guard

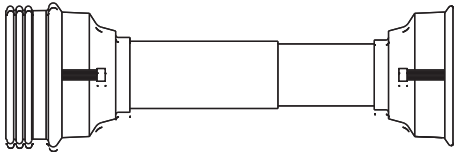

Nylon Bearing Kits Supplied

Stock Number	Series
950-1430	14 & 35
950-5548	55

(Guard must rotate freely on the yokes)

### NOTE:

\*Outer Guard is larger in order to shield CV half of the driveline.  
 \*50° CV joint and shaft half most commonly connects to the implement...ie: grain auger. Also, ball shear connects to the tractor PTO, which is the tube half.

### Yoke & Shaft

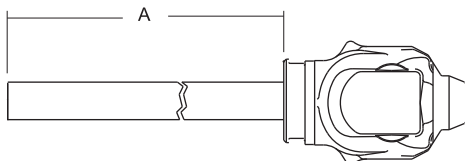

Stock Number	Series	Shaft Size	Dim. "A"
10501400	14	1" x 1 1/8" Rect.	29.38"

### Yoke & Tube

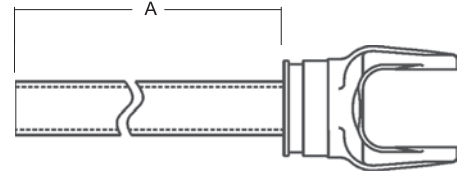

Stock Number	Series	Tube Size	Dim. "A"
11501400	14	1" 1/4" x 1 3/8" Rect.	34"

### Joint & Shaft Half with Guard

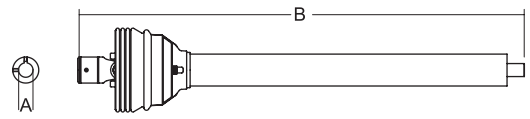

With Keyway, (2) Set Screws and Pinhole

Stock Number	Series	Dim. "A" Bore	Dim. "B"
19501420	14	1 1/4" Rd.	39.63"

### Constant Velocity Joint

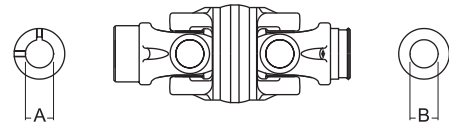

Stock Number	Series	Dim. "A" Bore	Dim. "B" Bore
18501420	14	1 1/4" Rd.*	1"
18511420	14	1 1/4" Rd.**	1"

\* (w/1/4" keyway & 2 set screws)  
 \*\* (w/keyway and pinhole)

### Ball Shear Device

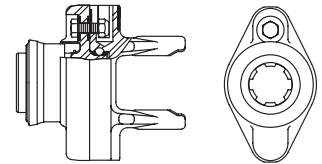

With Spring Lok

Stock Number	Dim. "A" Bore	Series	Shear Bolt
104-1406	1 3/8" x 6 Spl.	14	(1) 5/16" - 18 Gr. 5

Replacement Shear Bolt Part No. 11-10128

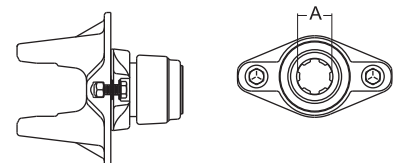

Stock Number	Dim. "A" Bore	Series	Shear Bolt
104-3506	1 3/8" x 6 Spl.	35	(2) 3/8" - 16 Gr. 5
104-5506	1 3/8" x 6 Spl.	55	(2) 3/8" - 16 Gr. 5

Replacement Shear Bolt Part No. 11-10445

CONSTANT VELOCITY

# METRIC SECTION

## 80° CV Category 3 / 2380 *(Interchanges with Walterscheid AW21)*

### UNEQUAL ARM

#### Cross & Bearing Kit (R-Kit)

*(Recommended 8 hr. grease interval)*

*Snap Ring Located In Yoke*

Stock Number	Dim. "A"		Dim. "B"		Dim. "C"		Dim. "D"	
	mm	in	mm	in	mm	in	mm	in
200-7491	74.6	2.93"	91.0	3.58"	23.8	.93"	27	1.06"

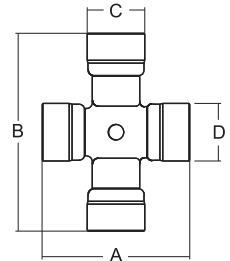

#### Cross & Bearing Kit (E-Kit)

*(Recommended 50 hr. grease interval)*

Stock Number	Dim. "A"		Dim. "B"		Dim. "C"		Dim. "D"	
	mm	in	mm	in	mm	in	mm	in
201-7491	74.6	2.93"	91.0	3.58"	23.8	.93"	27	1.06"

#### Tractor Yoke

##### Safety Slide Lock

*Repair Kit: 19-15094*

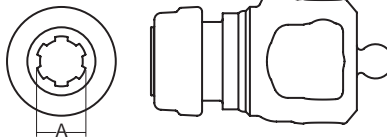

Stock Number	Dim. "A" Bore	
	mm	in
107-8406	1 3/8"	× 6 Spl.
107-8421	1 3/8"	× 21 Spl.

#### Roll Pin



Stock Number	Dim. "A"		Dim. "B"	
	mm	in	mm	in
508-1065	10.0	.393"	65.0	2.56"

#### Inner Profile Yoke

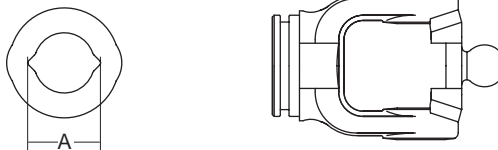

*With Bearing Groove  
(Guard must rotate freely on yoke)*

Stock Number	Dim. "A" Bore	
	mm	in
301-7434	34.5	1.36"
301-7439	39.0	1.53"

#### Center Housing

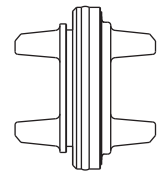

Stock Number	550-7400
--------------	----------

#### Inner Tube

**34.5 (4.0 Wall)  
1.358 (1.58 Wall)"**  
*Rilsan Coating*



Stock Number	Length	
	mm	in
406-7234	1000	39.37"

# METRIC SECTION

80° CV Category 3 / 2380 (Interchanges with Walterscheid AW21)

## UNEQUAL ARM

### Outer Profile Yoke

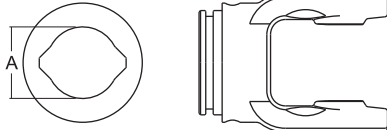

With Bearing Groove  
(Guard must rotate freely on yoke)

Stock Number	Dim. "A" Bore	
	mm	in
700-7441	41.0	1.614"

### 80° C.V. Joint

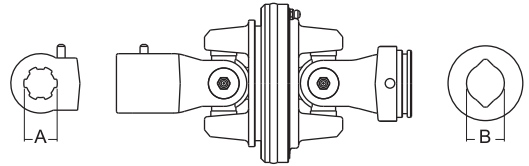

Stock Number	Dim. "A" Bore	Dim. "B" Bore	
		mm	in
15507406	1 3/8" × 6 Spl.	34.5	1.358"

### Easy Lock™ Replacement Kit

Part Number: 13005000 (4-per Kit)



### Guard Chain Kit

Insert the "S" hook through the guard loop and crimp shut

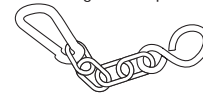

Part Number: 13006500 (2-per Kit)

CONSTANT  
VELOCITY

# METRIC SECTION

80° CV Category 4 / 2480 (Interchanges with Walterscheid AW35)

## UNEQUAL ARM

### Cross & Bearing Kit (R-Kit)

(Recommended 8 hr. grease interval)

Snap Ring Located In Yoke

Stock Number	Dim. "A"		Dim. "B"		Dim. "C"		Dim. "D"	
	mm	in	mm	in	mm	in	mm	in
200-7694	76	2.99"	94.0	3.70"	27	1.06"	32	1.26"

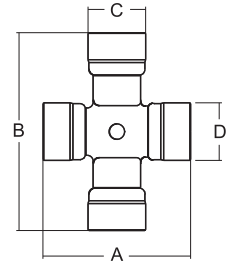

### Cross & Bearing Kit (E-Kit)

(Recommended 50 hr. grease interval)

Stock Number	Dim. "A"		Dim. "B"		Dim. "C"		Dim. "D"	
	mm	in	mm	in	mm	in	mm	in
201-7694	76	2.99"	94.0	3.70"	27	1.06"	32	1.26"

## EQUAL ARM

### Cross & Bearing Kit (R-Kit)

(Recommended 8 hr. grease interval)

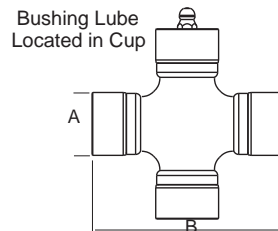

Stock Number	Dim. "A"		Dim. "B"	
	mm	in	mm	in
203-8692	30.2	1.19"	92.0	3.62"

### Extended Lubrication Cross & Bearing Kit (E-Kit)

(Recommended 50 hr. grease interval)

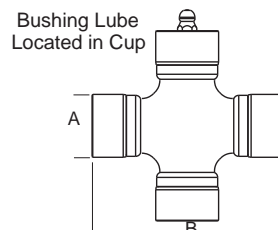

Stock Number	Dim. "A"		Dim. "B"	
	mm	in	mm	in
204-8692	30.2	1.19"	92.0	3.62"

CONSTANT VELOCITY

# METRIC SECTION

80° CV Category 4 / 2480 (Interchanges with Walterscheid AW35)

## UNEQUAL ARM

## EQUAL ARM

### Tractor Yoke

#### Safety Slide Lock

Repair Kit -  
\*19-15094  
\*\*13004020

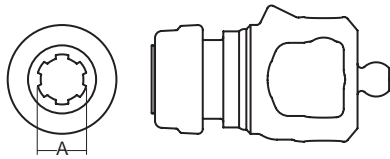

Stock Number	Dim. "A" Bore
107-7606*	1 3/8" × 6 Spl.
107-7620**	1 3/4" × 20 Spl.
107-7621*	1 3/8" × 21 Spl.

### Inner Profile Yoke

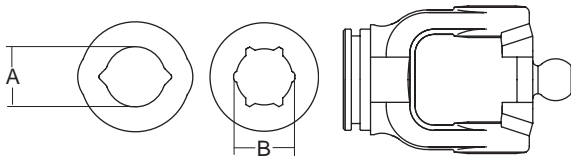

With Bearing Groove  
(Guard must rotate freely on yoke)

Stock Number	Dim. "A" Bore		Dim. "B" Bore	
	mm	in	mm	in
301-7639	40.0	1.56"		
301-7651			51.0	2.01"

### Inner Tube

40.0 (4.0 Wall)  
Rilsan Coating

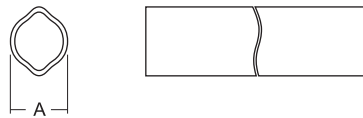

Stock Number	Dim. "A"		Length	
	mm	in	mm	in
402-7639	40.0	1.56"	1000	39.37"

### Tractor Yoke

#### Auto Lock

Repair Kit Part # 13004000

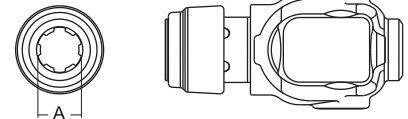

Stock Number	Dim. "A" Bore
111-8606	1 3/8" × 6 Spl.
111-8620	1 3/4" × 20 Spl.
111-8621	1 3/8" × 21 Spl.

### Inner Profile Yoke

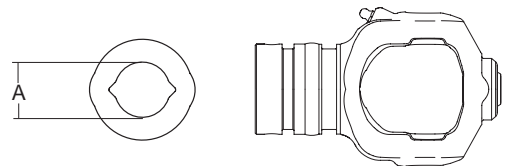

With Bearing Groove  
(Guard must rotate freely on yoke)

Stock Number	Dim. "A" Bore	
	mm	in
314-8639	40.0	1.56"

### Inner Tube

40.0 (4.0 Wall)  
Rilsan Coating

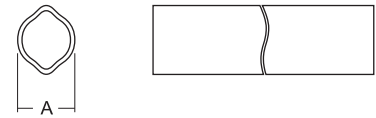

Stock Number	Dim. "A"		Length	
	mm	in	mm	in
402-7639	40.0	1.56"	1000	39.37"

CONSTANT  
VELOCITY

# METRIC SECTION

80° CV Category 4 / 2480 (Interchanges with Walterscheid AW35)

## UNEQUAL ARM

## EQUAL ARM

### Outer Profile Yoke

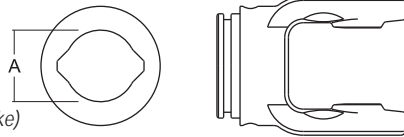

With Bearing Groove  
(Guard must rotate freely on yoke)

Stock Number	Dim. "A" Bore	
	mm	in
700-7648	48.0	1.890"

### Outer Profile Yoke

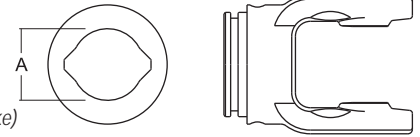

With Bearing Groove  
(Guard must rotate freely on yoke)

Stock Number	Dim. "A" Bore	
	mm	in
700-7648	48.0	1.890"

### Outer Tube



48.0 (4.0 Wall)  
4.0 Wall (Special)

Stock Number	Length	
	mm	in
606-7648	1000	39.37"

### Outer Tube



48.0 (4.0 Wall)  
4.0 Wall (Special)

Stock Number	Length	
	mm	in
604-7548	1000	39.37"

### Roll Pin



Stock Number	Dim. "A"		Dim. "B"	
	mm	in	mm	in
508-1080	10.0	.406"	80.0	3.156"

### Roll Pin



Stock Number	Dim. "A"		Dim. "B"	
	mm	in	mm	in
508-1080	10.0	.406"	80.0	3.156"

### Center Housing

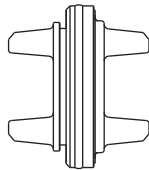

Stock Number	550-7600
--------------	----------

### Center Housing

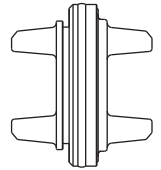

Stock Number	515-8600
--------------	----------

CONSTANT VELOCITY

# METRIC SECTION

## 80° CV Category 4 / 2480 (Interchanges with Walterscheid AW35)

### UNEQUAL ARM

### EQUAL ARM

#### 80° C.V. Joint

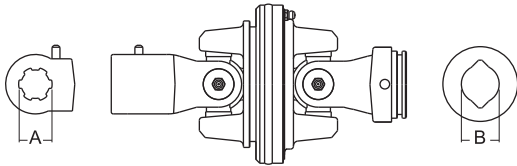

Stock Number	Dim. "A"	Dim. "B" Bore	
	Bore	mm	in
15507640	1 3/8" x 6 Spl.	40.0	1.562"

#### 80° C.V. Joint

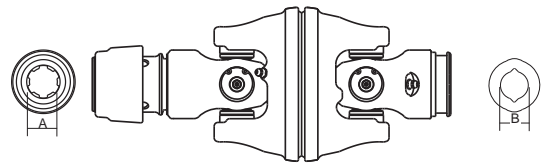

Stock Number	Dim. "A"	Dim. "B" Bore	
	Bore	mm	in
15598640	1 3/8" x 6 Spl.	40.0	1.562"

#### Guard

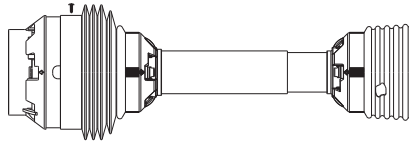

Bearings supplied with Guard

Stock Number	Overall Driveline Length	Bearing Kit (2 per kit)
	912-7648	
912-7660	60"	961-0035

Assembly instructions included with guard bearing kit  
NOTE: Guards must rotate freely on yokes

#### Guard

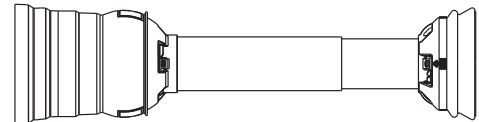

Bearings supplied with Guard

Stock Number	Overall Driveline Length	Bearing Kit (2 per kit)
	912-8648	
912-8660	60"	968-3536

Assembly instructions included with guard bearing kit  
NOTE: Guards must rotate freely on yokes

#### Easy Lock™ Replacement Kit

Part Number: 13005000 (4-per Kit)



#### Easy Lock™ Replacement Kit

Part Number: 13005000 (4-per Kit)



#### Guard Chain Kit

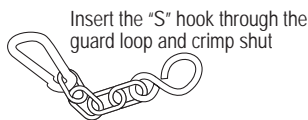

Part Number: 13006500 (2-per Kit)

#### Guard Chain Kit

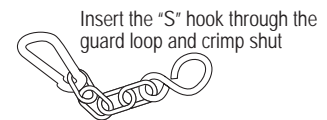

Part Number: 13006500 (2-per Kit)

#### Drivelines

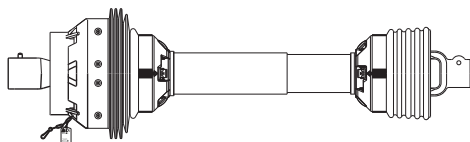

Stock Number	Availability	
14507648	No Longer Available In Unequal Arm	Use Part No. 14598648
14507660	No Longer Available In Unequal Arm	Use Part No. 14598660
14607648	No Longer Available In Unequal Arm	Use Part No. 14698648
14607660	No Longer Available In Unequal Arm	Use Part No. 14698660

#### Drivelines

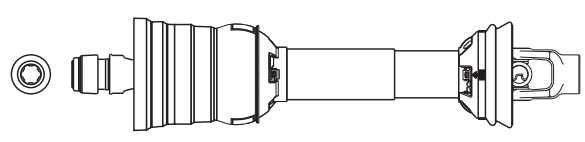

Stock Number	Tractor Yoke	Implement Yoke	Overall Compressed Driveline Length
14598648	1 3/8" x 6 Spl. AL	1 3/8" x 6 Spl. OD	48"
14598660	1 3/8" x 6 Spl. AL	1 3/8" x 6 Spl. OD	60"
14698648	1 3/8" x 21 Spl. AL	1 3/8" x 6 Spl. OD	48"
14698660	1 3/8" x 21 Spl. AL	1 3/8" x 6 Spl. OD	60"
14798660	1 3/4" x 20 Spl. AL	1 3/8" x 6 Spl. OD	60"

CONSTANT VELOCITY



# METRIC SECTION

## 80° CV Category 6 / 2580 (Interchanges with Walterscheid AW36)

### UNEQUAL ARM

#### Cross & Bearing Kit (R-Kit)

(Recommended 8 hr. grease interval)

Snap Ring Located In Yoke

Stock Number	Dim. "A"		Dim. "B"		Dim. "C"		Dim. "D"	
	mm	in	mm	in	mm	in	mm	in
200-7906	88.8	3.49"	106.0	4.17"	32.0	1.26"	36.0	1.42"

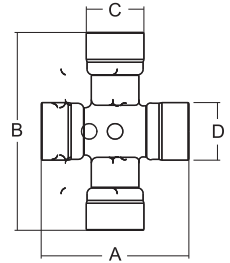

### EQUAL ARM

#### Cross & Bearing Kit (R-Kit)

(Recommended 8 hr. grease interval)

Snap Ring Located In Yoke

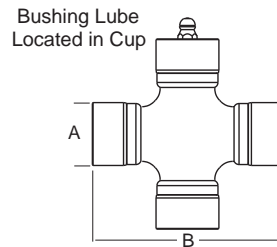

Stock Number	Dim. "A"		Dim. "B"	
	mm	in	mm	in
203-6806	34.94	1.38"	106.5	4.20"

#### Extended Lubrication Cross & Bearing Kit (E-Kit)

(Recommended 50 hr. grease interval)

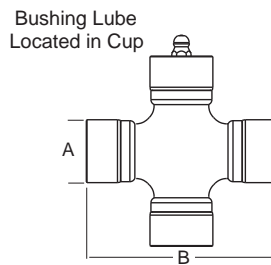

Stock Number	Dim. "A"		Dim. "B"	
	mm	in	mm	in
204-6806	34.94	1.38"	106.5	4.20"

CONSTANT  
VELOCITY

# METRIC SECTION

## 80° CV Category 6 / 2580 (Interchanges with Walterscheid AW36)

### UNEQUAL ARM

### EQUAL ARM

#### Tractor Yoke

##### Safety Slide Lock

Repair Kit -  
\*19-15094  
\*\*13004020

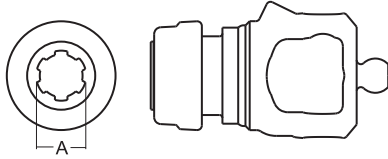

Stock Number	Dim. "A" Bore
107-7906*	1 3/8" x 6 Spl.
107-7920**	1 3/4" x 20 Spl.
107-7921*	1 3/8" x 21 Spl.

#### Inner Profile Yoke

With Bearing Groove  
(Guard must rotate freely on yoke)

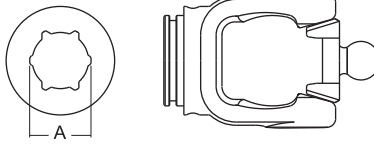

Stock Number	Dim. "A" Bore	
	mm	in
302-7951	51.0	2.0"

#### Inner Tube

##### Rilsan Coating

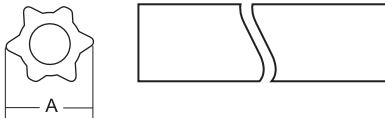

Stock Number	Dim. "A"		Length	
	mm	in	mm	in
406-7951	51.0	2.01"	1000	39.37"

#### Roll Pin

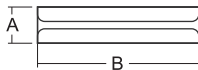

Stock Number	Dim. "A"		Dim. "B"	
	mm	in	mm	in
508-1090	10	.41"	90	3.54"

#### Tractor Yoke

##### Auto Lock

Repair Kit - 13004000

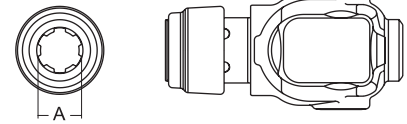

Stock Number	Dim. "A" Bore
111-6806	1 3/8" x 6 Spl.
111-6820	1 3/4" x 20 Spl.
111-6821	1 3/8" x 21 Spl.

#### Inner Profile Yoke

With Bearing Groove  
(Guard must rotate freely on yoke)

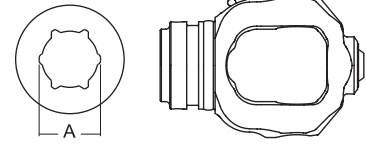

Stock Number	Dim. "A" Bore	
	mm	in
314-6851	51.0	2.0"

#### Inner Tube

##### Rilsan Coating

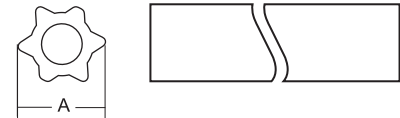

Stock Number	Dim. "A"		Length	
	mm	in	mm	in
406-7951	51.0	2.01"	1000	39.37"

#### Roll Pin

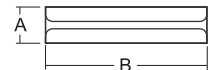

Stock Number	Dim. "A"		Dim. "B"	
	mm	in	mm	in
508-1090	10	.41"	90	3.54"

CONSTANT  
VELOCITY

# METRIC SECTION

## 80° CV Category 6 / 2580 (Interchanges with Walterscheid AW36)

### UNEQUAL ARM

### EQUAL ARM

#### Outer Tube



61.0 × 4.0

Stock Number	Length	
	mm	in
600-7961	1500	59.0"
604-7961	1000	39.37"

#### Outer Tube



61.0 × 4.0

Stock Number	Length	
	mm	in
600-7961	1500	59.0"
604-7961	1000	39.37"

#### Center Housing

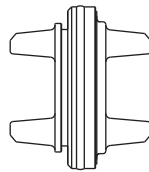

Stock Number
550-7900

#### Center Housing

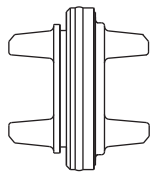

Stock Number
515-6800

#### Outer Profile Yoke

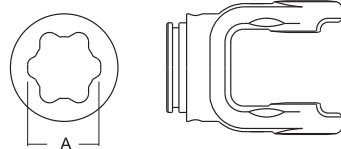

With Bearing Groove  
(Guard must rotate freely on yoke)

Stock Number	Dim. "A" Bore	
	mm	in
700-7961	61.0	2.402"

#### Outer Profile Yoke

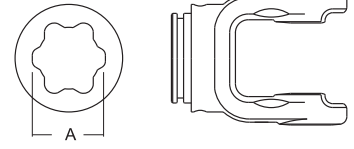

With Bearing Groove  
(Guard must rotate freely on yoke)

Stock Number	Dim. "A" Bore	
	mm	in
700-7961	61.0	2.402"

#### 80° C.V. Joint

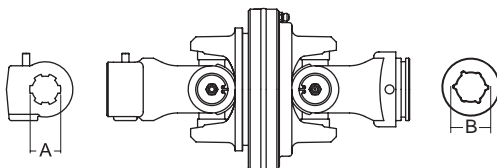

Stock Number	Dim. "A" Bore	Dim. "B" Bore	
		mm	in
15507951	1 3/8" × 6 Spl.	51.0	2.00"
15607951	1 3/8" × 21 Spl.	51.0	2.00"
15707951	1 3/4" × 20 Spl.	51.0	2.00"

#### 80° C.V. Joint

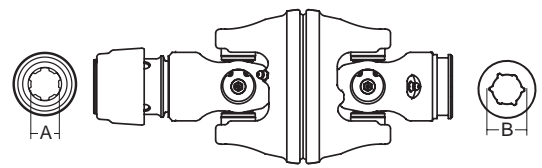

Stock Number	Dim. "A" Bore	Dim. "B" Bore	
		mm	in
15506851	1 3/8" × 6 Spl.	51.0	2.00"
15606851	1 3/8" × 21 Spl.	51.0	2.00"
15706851	1 3/4" × 20 Spl.	51.0	2.00"

CONSTANT VELOCITY

# METRIC SECTION

80° CV Category 6 / 2580 (Interchanges with Walterscheid AW36)

## UNEQUAL ARM

## EQUAL ARM

### Yoke & Tube Assembly w/Guard

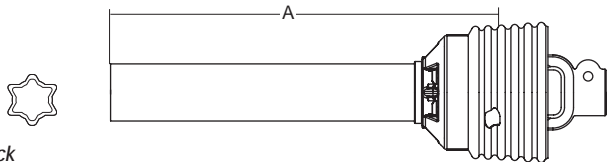

Stock Number		
92-14507951	No Longer Available In Unequal Arm	Use Part No. 92-14506851
92-14507955	No Longer Available In Unequal Arm	Use Part No. 92-14506855
92-14517955	No Longer Available In Unequal Arm	Use Part No. 92-14516855
92-14627955	No Longer Available In Unequal Arm	Use Part No. 92-14626855
92-14637955	No Longer Available In Unequal Arm	Use Part No. 92-14636855

\*CL = Centerline

### Joint & Shaft w/Guard

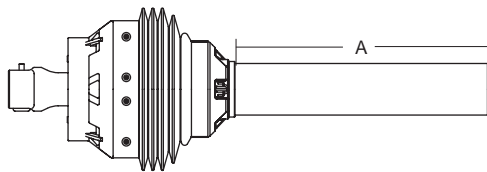

Stock Number		
93-14507951	No Longer Available In Unequal Arm	Use Part No. 93-14506851
93-14517955	No Longer Available In Unequal Arm	Use Part No. 93-14516855
93-14607951	No Longer Available In Unequal Arm	Use Part No. 93-14606851
93-14617955	No Longer Available In Unequal Arm	Use Part No. 93-14616855
93-14707951	No Longer Available In Unequal Arm	Use Part No. 93-14706851
93-14717955	No Longer Available In Unequal Arm	Use Part No. 93-14716855

### Guard

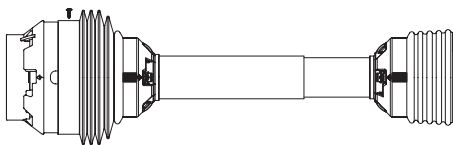

Bearings supplied with Guard

Stock Number	Overall Driveline Length	Bearing Kit (2 per kit)
912-7948	48"	961-0036
912-7960	60"	961-0036

Assembly instructions included with guard bearing kit  
NOTE: Guards must rotate freely on yokes

### Easy Lock™ Replacement Kit

Part Number: 13005000 (4-per Kit)



### Guard Chain Kit

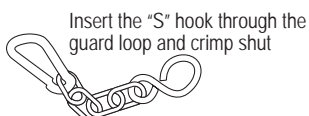

Part Number: 13006500 (2-per Kit)

### Yoke & Tube Assembly w/Guard

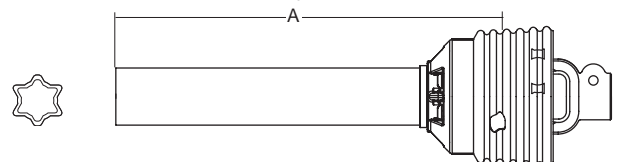

Stock Number	Profile Tube	Dim. "A"	Implement Yoke
92-14506851	61.0 (Star)	30.75"	1 3/4" × 20 Spl. w/ Clamp
92-14506855	61.0 (Star)	34.625"	1 3/8" × 6 Spl. w/Clamp
92-14516855	61.0 (Star)	34.625"	1 3/4" × 20 Spl. w/Clamp
92-14626855	61.0 (Star)	34.625"	1 3/8" × 21 Spl. w/Clamp
92-14636855	61.0 (Star)	34.625"	1 3/8" × 21 Spl. w/Pinhole

\*CL = Centerline

### Joint & Shaft w/Guard

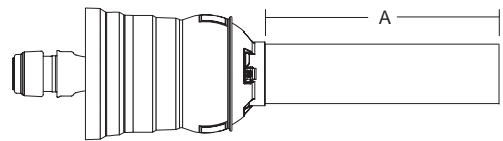

Stock Number	Profile Shaft	Dim. "A"	Tractor Yoke
93-14506851	51.0 (Star)	26.0"	1 3/4" × 20 Spl.
93-14516855	51.0 (Star)	30.0"	1 3/8" × 6 Spl.
93-14606851	51.0 (Star)	26.0"	1 3/4" × 20 Spl.
93-14616855	51.0 (Star)	30.0"	1 3/8" × 21 Spl.
93-14706851	51.0 (Star)	26.0"	1 3/8" × 21 Spl.
93-14716855	51.0 (Star)	30.0"	1 3/8" × 21 Spl.

### Guard

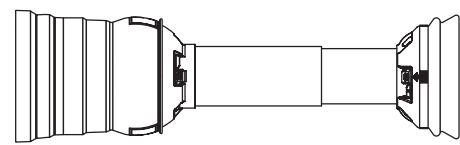

Bearings supplied with Guard

Stock Number	Fits Overall Driveline Driveline Length	Bearing Kit (2 per kit)
912-6862	62"	968-0036

Assembly instructions included with guard bearing kit  
NOTE: Guards must rotate freely on yokes

### Easy Lock™ Replacement Kit

Part Number: 13005000 (4-per Kit)



### Guard Chain Kit

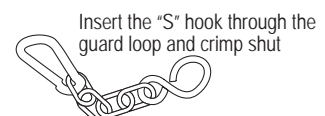

Part Number: 13006500 (2-per Kit)

CONSTANT  
VELOCITY

# METRIC SECTION

## 80° CV Category 6 / 2580 (Interchanges with Walterscheid AW36)

### UNEQUAL ARM

#### Drivelines

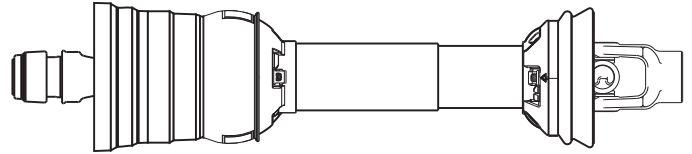

Stock  
Number

14507948	OBSOLETE	
14507951	No Longer Available In Unequal Arm	Use Part No. 14506851
14507955	No Longer Available In Unequal Arm	Use Part No. 14506855
14507960	No Longer Available In Unequal Arm	Use Part No. 14506860
14517955	No Longer Available In Unequal Arm	Use Part No. 14516855
14547955	No Longer Available In Unequal Arm	Use Part No. 14546855
14607948	OBSOLETE	
14607951	No Longer Available In Unequal Arm	Use Part No. 14606851
14607955	No Longer Available In Unequal Arm	Use Part No. 14606855
14607960	No Longer Available In Unequal Arm	Use Part No. 14606860
14607962	No Longer Available In Unequal Arm	Use Part No. 14606862
14617955	No Longer Available In Unequal Arm	Use Part No. 14616855
14627955	No Longer Available In Unequal Arm	Use Part No. 14626855
14637955	No Longer Available In Unequal Arm	Use Part No. 14636855
14647955	No Longer Available In Unequal Arm	Use Part No. 14646855
14707951	No Longer Available In Unequal Arm	Use Part No. 14706851
14707955	No Longer Available In Unequal Arm	Use Part No. 14706855
14707962	No Longer Available In Unequal Arm	Use Part No. 14706862
14717955	No Longer Available In Unequal Arm	Use Part No. 14716855
14727955	No Longer Available In Unequal Arm	Use Part No. 14726855
14737955	No Longer Available In Unequal Arm	Use Part No. 14736855
14747955	No Longer Available In Unequal Arm	Use Part No. 14746855

CONSTANT  
VELOCITY

### EQUAL ARM

#### Drivelines

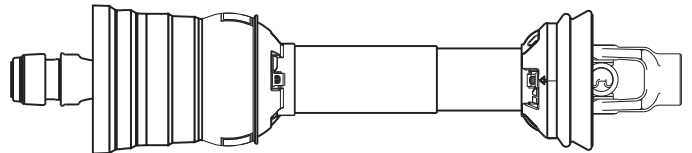

Maximum Overall  
Extended Operating

Stock Number	Shaft	Overall Compressed Length	Length	Tractor Yoke		Implement Yoke	
14506851	Star 51 mm	51"	62.5"	1 3/8" × 6 Spl.	AL	1 3/4" x 20 Spl.	Clamp
14506855	Star 51 mm	55"	68.5"	1 3/8" × 6 Spl.	AL	1 3/8" x 6 Spl.	Clamp
14506860	Star 51 mm	60"	77.25"	1 3/8" × 6 Spl.	AL	1 3/8" x 6 Spl.	Clamp
14516855	Star 51 mm	55"	68.5"	1 3/8" × 6 Spl.	AL	1 3/4" x 20 Spl.	Clamp
14546855	Star 51 mm	55"	68.5"	1 3/8" × 6 Spl.	AL	1 3/4" x 6 Spl.	Clamp
14606851	Star 51 mm	51"	62.5"	1 3/8" × 21 Spl.	AL	1 3/4" x 20 Spl.	Clamp
14606855	Star 51 mm	55"	68.5"	1 3/8" × 21 Spl.	AL	1 3/8" x 6 Spl.	Clamp
14606860	Star 51 mm	60"	77.25"	1 3/8" × 21 Spl.	AL	1 3/8" x 6 Spl.	Clamp
14606862	Star 51 mm	62"	79"	1 3/8" × 21 Spl.	AL	1 3/4" Round w/Keyway	
14616855	Star 51 mm	55"	68.5"	1 3/8" × 21 Spl.	AL	1 3/4" x 20 Spl.	Clamp
14626855	Star 51 mm	55"	68.5"	1 3/8" × 21 Spl.	AL	1 3/8" x 21 Spl.	Clamp
14636855	Star 51 mm	55"	68.5"	1 3/8" × 21 Spl.	AL	1 3/8" x 21 Spl. w/Pinhole	
14646855	Star 51 mm	55"	68.5"	1 3/8" × 21 Spl.	AL	1 3/4" x 6 Spl.	Clamp
14706851	Star 51 mm	51"	62.5"	1 3/4" × 20 Spl.	AL	1 3/4" x 20 Spl.	Clamp
14706855	Star 51 mm	55"	68.5"	1 3/8" × 20 Spl.	AL	1 3/8" x 6 Spl.	Clamp
14706862	Star 51 mm	62"	79"	1 3/4" × 20 Spl.	AL	1 3/4" Round w/Keyway	
14716855	Star 51 mm	55"	68.5"	1 3/4" × 20 Spl.	AL	1 3/4" x 20 Spl.	Clamp
14726855	Star 51 mm	55"	68.5"	1 3/4" × 20 Spl.	AL	1 3/8" x 21 Spl.	Clamp
14736855	Star 51 mm	55"	68.5"	1 3/4" × 20 Spl.	AL	1 3/8" x 21 Spl. w/Pinhole	
14746855	Star 51 mm	55"	68.5"	1 3/4" × 20 Spl.	AL	1 3/4" x 6 Spl.	Clamp

# METRIC SECTION

## 80° CV Tri-Lobe

### 4 Series

#### Tractor Half

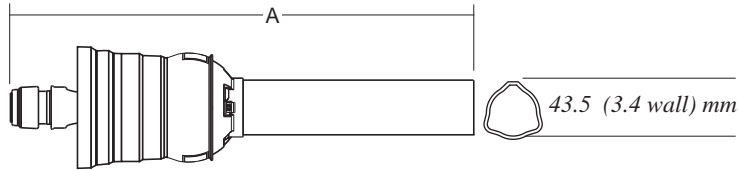

Stock Number	Tractor Yoke	Dim. "A"
93-14586460	1 3/8" x 6 Spl.	52"
93-14686460	1 3/8" x 21 Spl.	52"

### 6 Series

#### Tractor Half

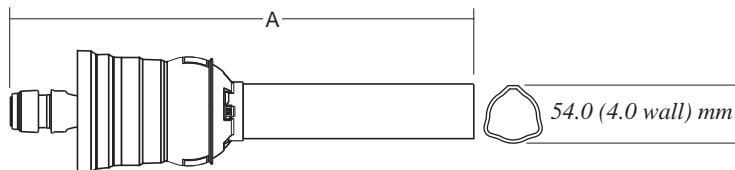

Stock Number	Tractor Yoke	Dim. "A"
93-14586660	1 3/8" x 6 Spl.	52"
93-14686660	1 3/8" x 21 Spl.	52"
93-14786660	1 3/4" x 20 Spl.	52"

### 8 Series

#### Tractor Half

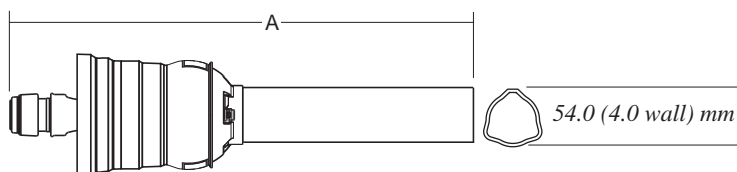

Stock Number	Tractor Yoke	Dim. "A"
93-14586860	1 3/8" x 6 Spl.	54"
93-14686860	1 3/8" x 21 Spl.	54"
93-14786860	1 3/4" x 20 Spl.	54"





**Weasler®**

## Aftermarket Product Guide



# Clutches



## NORTH AMERICAN

Weasler 14,35,44,55

Interchanges with:

Neapco 2600 Series and

Walterscheid 1480 Series

## METRIC

Interchanges with:

Bondioli and Pavesi, 4, 5, 6, and

8 Series and Walterscheid 2300,  
2400 and 2500 Series

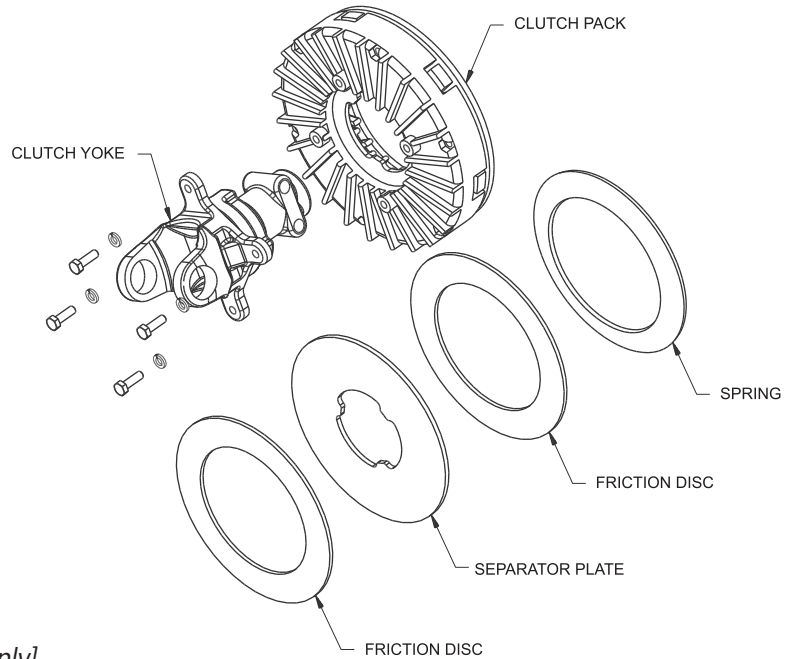

[For use on implement end of driveline only]

The drawing illustrates the components of the **TORQMASTER**. Each component of the exploded view is identified by an eight-digit stock number to ensure identification.

Number Identification Examples:

570-9000	Torque in•lbs Diameter of Clutch Pak
817-3506	6 Spline 35 Series Clamp Yoke for Friction Clutch Implement Yoke
825-4422	1 3/8" Round Bore* 44 Series Round Bore for Friction Clutch Implement Yoke

821-1406	6 Spline 14 Series Auto-Lok for Overrunning Clutch Implement Yoke
----------	--

818-8406	6 Spline By/Py 4 Series and W/S 2300 Series Interchanges with both By/Py and W/S Clamp Yoke for Overrunning Clutch Implement Yoke
----------	---

970-7000	Diameter of Clutch Pak Friction Disc
----------	---

990-7000	Diameter of Clutch Pak Separator Plate
----------	---

\*1/16th Increments

**NOTE:** Overrunning Clutch Paks must be mated with overrunning yokes

## Features and Benefits

- Superior performance
- Long life
- Isolates/dissipates heat
- “User Friendly” - easy to service
- Easy assembly with 1/2” wrench
- Free motion - ease of hook-up
- Minimum adjustment required
- Auto-Lok available
- Replacement clutch for most farm implements\*
- Torque setting from 9,000 in•lbs to 21,000 in•lbs
- Overrunning feature also available
- Modular construction covers a wide variety of applications
- Applications for the TorQmaster Modular Clutch:
  - Spreaders
  - Mower conditioners
  - Flail shredders
  - Balers
  - Mixers
  - Rotary cutters
  - Grain carts
  - Snowblowers

\* For use on implement end of driveline only

## Instructions for ordering the **TORQMASTER** Clutch

- Determine the driveline series *Transparency Identification System* for either North American or Metric applications (see Pages 43 and 87).
- Identify the connecting shaft size and the method of attachment (eg: clamp, bolt, keyway).
- Obtain torque setting from owner/operator manual - if available.
- If torque setting is not available, use the following *Clutch Pak Selection Guide* (Pages 181 and 182) as a guideline for selecting the proper clutch pak.
- Order clutch yoke and clutch pak separately by stock number.
- For installation, attach clutch to the driveline first, then mount the clutch pak to the clutch yoke.
- Use the modular clutch on the implement end of the driveline only.
- If the implement input connection guard is removed for service, re-install the guard before using the machine.
- Some implements (eg:mower conditioner; flail shredder) require an overrunning feature incorporated into the clutch. If the replacement clutch requires this feature, order the appropriate overrunning modular clutch and overrunning clutch yoke.

# Assembly Instructions for the **TORQMASTER** Modular Clutch

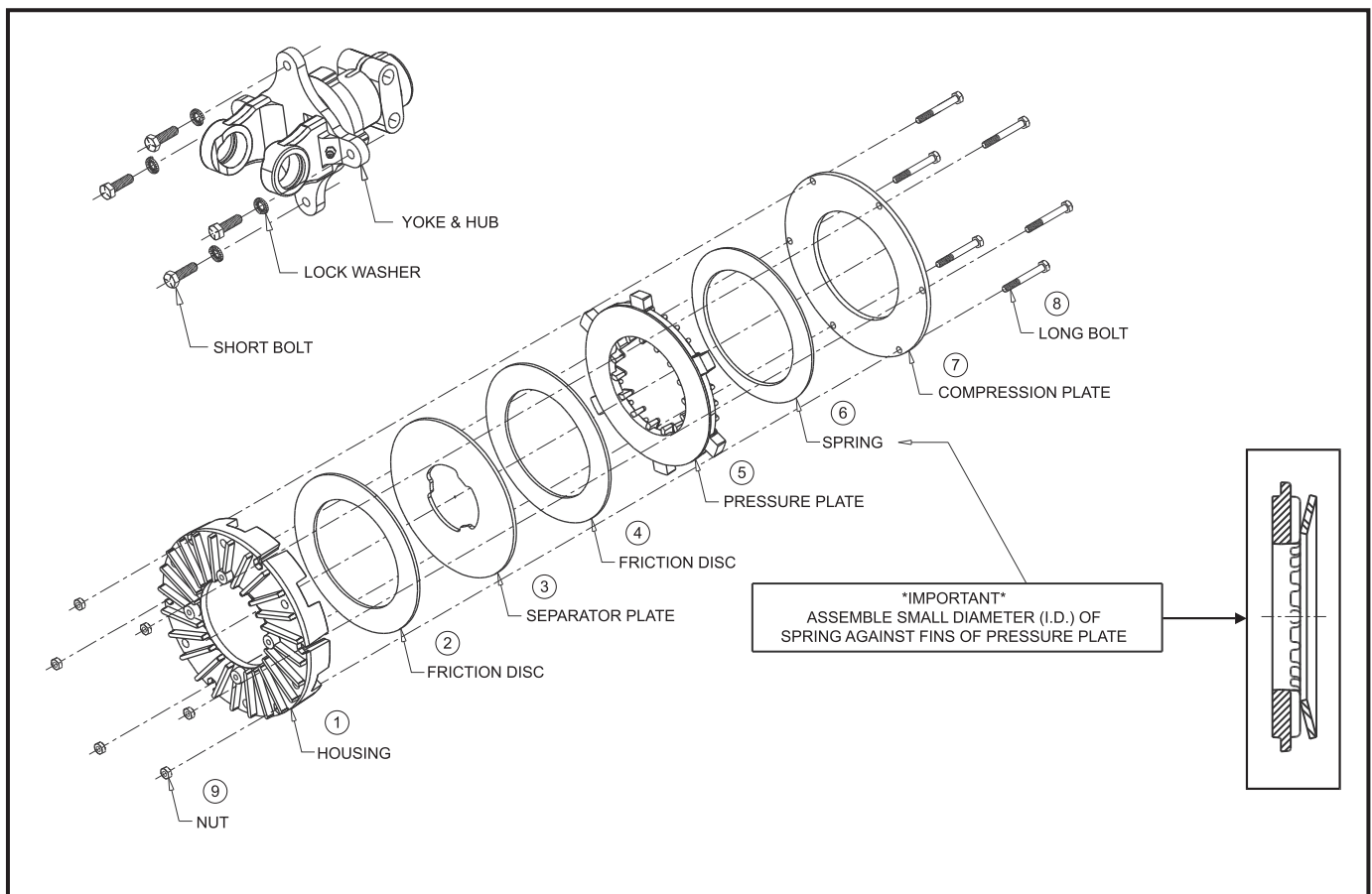

## Run-In of the **TORQMASTER** Modular Clutch (Instructions)

If the clutch has not been operated for (1) season we recommend the following:

### TOOLS REQUIRED:

(1) 1/2" box wrench or socket

1. Make sure the tractor is off and the PTO is disengaged.
2. Disconnect the driveline from the tractor.
3. Locate the bolts on the O.D. of the clutch pak. Loosen the bolts until all are finger tight, then tighten each one half a turn.
4. Attach the implement to the tractor at the hitch pin, and the driveline to the tractor PTO.
5. Turn the tractor on. Engage the PTO clutch and run for a few seconds, or until the clutch visibly smokes.
6. Disengage the tractor PTO and shut off the tractor. Keep clear of the machine until all parts stop moving.
7. Disconnect the driveline from the tractor.
8. Tighten the bolts on the O.D. of the clutch pak until the compression plate is in full contact with the housing.
9. If the clutch contains an integral overrunning clutch, make sure the clutch spins freely in one direction.

### Spreader

Friction Clutch Stock Number	Overrunning Clutch Stock Number	540 RPM in-lb-torque	1000 RPM in-lb-torque
<i>Capacity: Less than 240 Bushels or 150 cu.ft.</i>			
57012000	57112000	12000	
<i>Capacity: Between 241-400 Bushels or 151 - 250 cu.ft.</i>			
57012000	57112000		12000
57015000	57115000	15000	
<i>Capacity: Between 401-560 Bushels or 251 - 350 cu.ft.</i>			
57015000	57115000		15000
57018000	57118000	18000	
<i>Capacity: Greater than 560 Bushels or 350 cu.ft.</i>			
57018000	57118000		18000
57018000	57118000	18000	

### Mixer

Friction Clutch Stock Number	Overrunning Clutch Stock Number	540 RPM in-lb-torque	1000 RPM in-lb-torque
<i>Capacity: Less than 240 Bushels or 150 cu.ft.</i>			
57012000	57112000	12000	
<i>Capacity: Between 241-400 Bushels or 151 - 250 cu.ft.</i>			
57012000	57112000		12000
57015000	57115000	15000	
<i>Capacity: Between 401-560 Bushels or 251 - 350 cu.ft.</i>			
57015000	57115000		15000
57018000	57118000	18000	
<i>Capacity: Greater than 560 Bushels or 350 cu.ft.</i>			
57018000	57118000		18000
57018000	57118000	18000	

### Snowblowers

Friction Clutch Stock Number	540 RPM in-lb-torque	1000 RPM in-lb-torque
<i>Width of Cut: Less than 60".</i>		
57012000		12000
57015000	15000	
<i>Width of Cut: 61" - 70"</i>		
57015000		15000
57018000	18000	
<i>Width of Cut: 71" - 80"</i>		
57018000		18000
57018000	18000	
<i>Width of Cut: 81" - 90"</i>		
57018000	NA	18000
<i>Width of Cut: Greater than 90"</i>		
57018000	NA	18000

### Mower Conditioner

Friction Clutch Stock Number	Overrunning Clutch Stock Number	540 RPM in-lb-torque	1000 RPM in-lb-torque
<i>Sickle Bar - less than 10 feet</i>			
57012000	57112000	12000	
<i>Sickle Bar - 10 - 13 feet</i>			
57012000	57112000		12000
57015000	57115000	15000	
<i>Sickle Bar - 14 - 17 feet</i>			
57015000	57115000		15000
57018000	57118000	18000	

Friction Clutch Stock Number	Overrunning Clutch Stock Number	540 RPM in-lb-torque	1000 RPM in-lb-torque
<i>Rotary Disk - less than 10 feet</i>			
57012000	57112000		12000
<i>Rotary Disk - 11 - 13 feet</i>			
57015000	57115000		15000
<i>Rotary Disk - 14 - 17 feet</i>			
57018000	57118000		18000

### Rotary Cutter

1 Clutch/Machine

Friction Clutch Stock Number	Overrunning Clutch Stock Number	540 RPM in-lb-torque	1000 RPM in-lb-torque
<i>Deck Width - 4 - 7 feet</i>			
570-9000	571-9000		9000
57012000	57112000	12000	
<i>Deck Width - 8 - 13 feet</i>			
57012000	57112000		12000
57015000	57115000	15000	
<i>Deck Width - 14 - 16 feet</i>			
57015000	57115000		15000
57018000	57118000	18000	
<i>Deck Width - 17- 20 feet</i>			
57018000	57118000		18000
57018000	57118000	18000	
<i>Deck Width - larger than 20 feet</i>			
57018000	57118000		18000

### Rotary Cutter cont.

1 Clutch/Machine

Friction Clutch Stock Number	Overrunning Clutch Stock Number	540 RPM in-lb-torque	1000 RPM in-lb-torque
<b>Section Width - 4 - 6 feet</b>			
57019000	57119000		9000
57012000	57112000	12000	
<b>Section Width - greater than 6 feet</b>			
57012000	57112000		12000
57015000	57115000	15000	

### Flail Shredder

Friction Clutch Stock Number	Overrunning Clutch Stock Number	540 RPM in-lb-torque	1000 RPM in-lb-torque
<b>Less than 10 feet</b>			
57015000	57115000		15000
57018000	57118000	18000	
<b>10 - 15 feet</b>			
57018000	57118000		18000
57018000	57118000	18000	
<b>Greater than 15 feet</b>			
57018000			18000

### Round Baler

Friction Clutch Stock Number	Overrunning Clutch Stock Number	540 RPM in-lb-torque	1000 RPM in-lb-torque
<b>Bale Weight - less than 600 lbs.</b>			
57012000	57112000	12000	
<b>Bale Weight - 600 - 1500 lbs.</b>			
57012000	57112000		12000
57015000	57115000	15000	
<b>Bale Weight - 1501- 2500 lbs</b>			
57012000	57112000		12000
57018000	57118000	18000	

### Grain Cart

Friction Clutch Stock Number	Overrunning Clutch Stock Number	540 RPM in-lb-torque	1000 RPM in-lb-torque
57012000	57112000	12000	
<b>Up to 750 Bushels</b>			
57015000	57115000	15000	
<b>Above 750 Bushels</b>			
57018000	57118000	18000	

If you have an implement that does NOT appear in the Clutch Pak Selection Guide, use the following chart as a general guideline for selecting the proper Clutch Pak.

North American	Metric	Stock Number
14 Series	Bondioli & Pavesi 4 Series	57012000
	Walterscheid 2300 Series	
35 Series	Bondioli & Pavesi 5 Series	57015000
	Walterscheid 2400 Series	
44 Series	Bondioli & Pavesi 6 & 7 Series	57018000
	Walterscheid II Series	
55 Series	Bondioli & Pavesi 8 Series	57018000
	Walterscheid 2500 & 2600 Series	

See Page 179 for Clutch Pak ordering information

### Clutch Pak Product Information

#### Adjustment detail - 7" and 9" Clutch Paks

- No spring adjustment required
- Tighten bolts to 30 ft-lbs (max)

You will find some overlap within an implement category in the *Clutch Pak Selection Guide*. The operator will generally know if he has a heavy duty or light duty application. If in doubt, always protect the driveline... refer to the "general guideline for selecting proper "clutch pak" on this page.

## North American Section

### TORQMASTER

#### Clutch Paks 7" & 9"

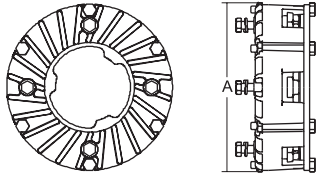

Clutch Pak Stock Number	Overrunning Clutch Stock Number	in-lbs	Dim. "A"	Disc Replacement Stock Number
570-9000	571-9000	9000	7"	970-7000
57012000	57112000	12000	7"	970-7000
57015000	57115000	15000	7"	970-7000
57018000	57118000	18000	7"	970-7000
59010000	59110000	10000	9.36"	970-9000
59015000	59115000	15000	9.36"	970-9000
59018000	59118000	18000	9.36"	970-9000
59021000	59121000	21000	9.36"	970-9000

NOTE!  
Torqmaster clutch paks must be used with mating Torqmaster yoke that has same flange configuration only.

### 14 Series continued...

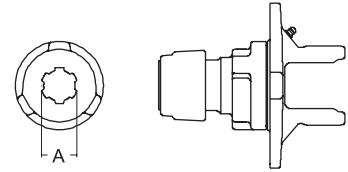

Auto-Lok Yoke Stock Number	Overrunning Auto-Lok Yoke Stock Number	Dim. "A" Bore
820-1406	821-1406	1 3/8" x 6 Spl.
820-1421	821-1421	1 3/8" x 21 Spl.

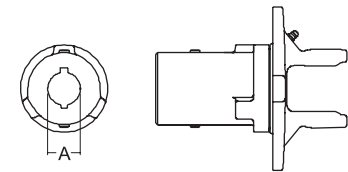

Round Bore Yoke Stock Number	Overrunning Round Bore Yoke Stock Number	Dim. "A" Bore w / Keyway & Set-screw
825-1420	826-1420	1 1/4" Rd.
825-1422	826-1422	1 3/8" Rd.

### 14 Series

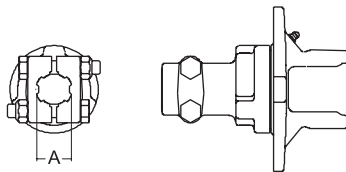

Clamp Yoke Stock Number	Overrunning Clamp Yoke Stock Number	Dim. "A" Bore
817-1406	818-1406	1 3/8" x 6 Spl.
817-1421		1 3/8" x 21 Spl.

### 35 Series

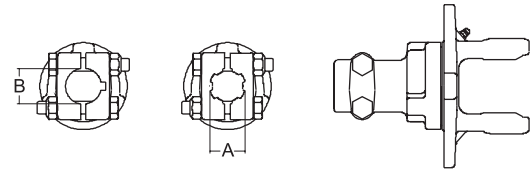

Clamp Yoke Stock Number	Overrunning Clamp Yoke Stock Number	Dim. "A" Bore	Dim. "B" Bore w / Keyway
817-3506	818-3506	1 3/8" x 6 Spl.	
817-3521	818-3521	1 3/8" x 21 Spl.	
817-3524	818-3524		1 1/2" Rd.

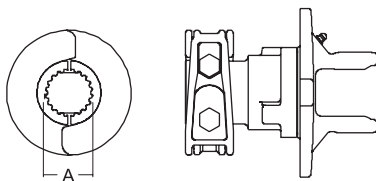

Clamp Yoke Stock Number	Overrunning Clamp Yoke Stock Number	Dim. "A" Bore
817-1420		1 3/4" x 20 Spl.

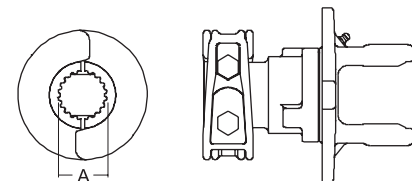

Clamp Yoke Stock Number	Overrunning Clamp Yoke Stock Number	Dim. "A" Bore
817-3520	818-3520	1 3/4" x 20 Spl.

# Clutch Components

## 35 Series continued...

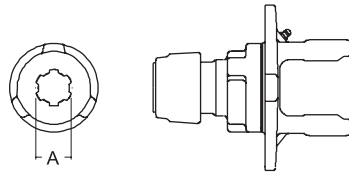

Auto-Lok Yoke Stock Number	Overrunning Auto-Lok Yoke Stock Number	Dim. "A" Bore
820-3506	821-3506	1 3/8" x 6 Spl.
820-3520	821-3520	1 3/4" x 20 Spl.
820-3521	821-3521	1 3/8" x 21 Spl.

## 44 Series continued...

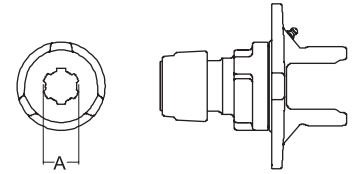

Auto-Lok Yoke Stock Number	Overrunning Auto-Lok Yoke Stock Number	Dim. "A" Bore
820-4406	821-4406	1 3/8" x 6 Spl.
820-4420	821-4420	1 3/4" x 20 Spl.
820-4421	821-4421	1 3/8" x 21 Spl.

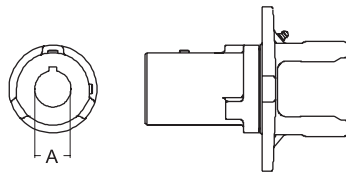

Round Bore Yoke Stock Number	Overrunning Round Bore Yoke Stock Number	Dim. "A" w / Keyway Set-screw
825-3520	826-3520	1 1/4" Rd. Dbl. KW
825-3522	826-3522	1 3/8" Rd.
825-3524	826-3524	1 1/2" Rd.

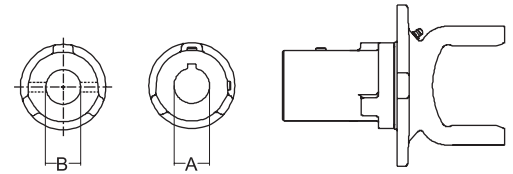

Round Bore Yoke Stock Number	Overrunning Round Bore Yoke Stock Number	Dim. "A" Bore w / Keyway Set-screw	Dim. "B" Bore w / 3/8" Pinhole
825-4420	826-4420	1 1/4" Rd.	
825-4422	826-4422	1 3/8" Rd.	
825-4428	826-4428	1 3/4" Rd.	
827-4432	Not Available		2" Rd.

## 44 Series

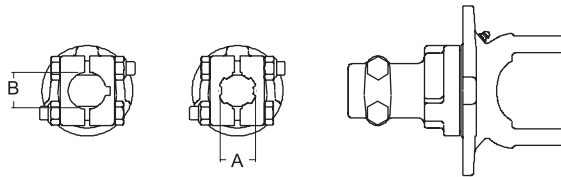

Clamp Yoke Stock Number	Overrunning Clamp Yoke Stock Number	Dim. "A"	Dim. "B" w / Keyway
817-4406	818-4406	1 3/8" x 6 Spl.	
817-4421	818-4421	1 3/8" x 21 Spl.	
817-4424	818-4424		1 1/2" Rd.

## I-Type Friction Clutch

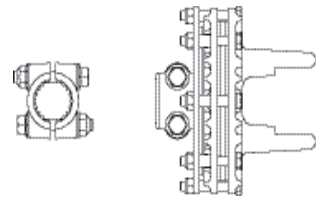

Stock Number	Type	Clutch Setting	Dim. "A" Bore
566-4420*	Dbl.Clamp	13,276 in-lbs	1 3/4" x 20 Spl.
566-4421*	Dbl.Clamp	13,276 in-lbs	1 3/8" x 21 Spl.

\* Use replacement Friction Disc 970-1700

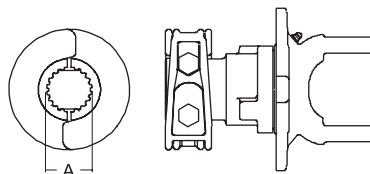

Clamp Yoke Stock Number	Overrunning Clamp Yoke Stock Number	Dim. "A" Bore
817-4420	818-4420	1 3/4" x 20 Spl.

## 55 Series

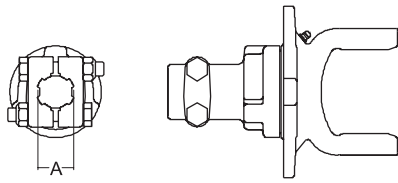

Clamp Yoke Stock Number	Overrunning Clamp Yoke Stock Number	Dim. "A" Bore
817-5506	818-5506	1 3/8" x 6 Spl.
817-5521	818-5521	1 3/8" x 21 Spl.

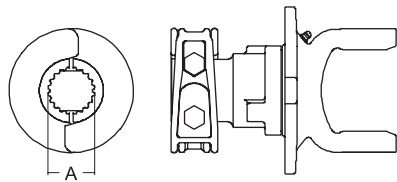

Clamp Yoke Stock Number	Overrunning Clamp Yoke Stock Number	Dim. "A" Bore
817-5520	818-5520	1 3/4" x 20 Spl.
817-5527	818-5527	1 3/4" x 27 Spl.
817-5528		1 3/4" x 6 Spl.

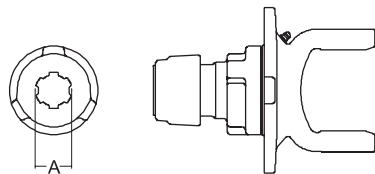

Auto-Lok Yoke Stock Number	Overrunning Auto-Lok Yoke Stock Number	Dim. "A" Bore
820-5506	821-5506	1 3/8" x 6 Spl.
820-5520	821-5520	1 3/4" x 20 Spl.
820-5521	821-5521	1 3/8" x 21 Spl.

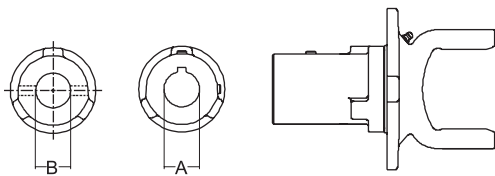

Round Bore Yoke Stock Number	Overrunning Round Bore Yoke Stock Number	Dim. "A" Bore w / Keyway & Set-screw	Dim. "B" Bore w / 3/8" Pinhole
825-5522	826-5522	1 3/8" Rd.	
825-5528	826-5528	1 3/4" Rd.	
827-5532	Not Available		2" Rd.



## Metric Section

### TORQMASTER

#### Clutch Paks 7" & 9"

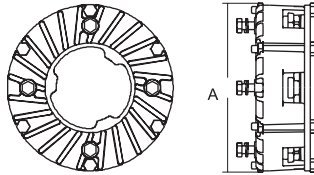

Clutch Pak Stock Number	Overrunning Clutch Stock Number	in-lbs	Dim. "A"	Disc Replacement Stock Number
570-9000	571-9000	9000	7"	970-7000
57012000	57112000	12000	7"	970-7000
57015000	57115000	15000	7"	970-7000
57018000	57118000	18000	7"	970-7000
59010000	59110000	10000	9.36"	970-9000
59015000	59115000	15000	9.36"	970-9000
59018000	59118000	18000	9.36"	970-9000
59021000	59121000	21000	9.36"	970-9000

**NOTE!**

Torqmaster clutch paks must be used with mating Torqmaster yoke that has same flange configuration only

Interchanges with:

#### Walterscheid 1480 Series Neapco 2600 Series

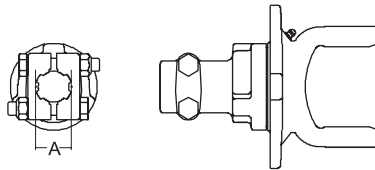

Clamp Yoke Stock Number	Overrunning Clamp Yoke Stock Number	Dim. "A" Bore
817-2606	818-2606	1 3/8" x 6 Spl.

Interchanges with:

#### Walterscheid 1480 Series Neapco 2600 Series

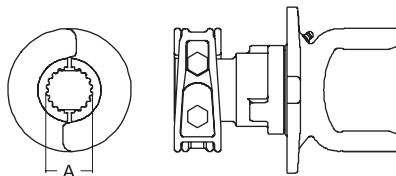

Clamp Yoke Stock Number	Overrunning Clamp Yoke Stock Number	Dim. "A" Bore
817-2620	818-2620	1 3/4" x 20 Spl.

Interchanges with:

#### Bondioli & Pavesi 2 Series Walterscheid 2200 Series

#### Ratchet Clutch

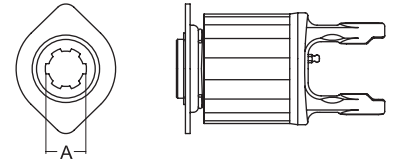

Stock Number	Type	Clutch Setting	Dim. "A" Bore
570-8206	Spring Lock	2600 in-lbs	1 3/8 x 6 Spl.

Interchanges with:

#### Bondioli & Pavesi 3 Series Walterscheid 1 Series

#### Ratchet Clutch

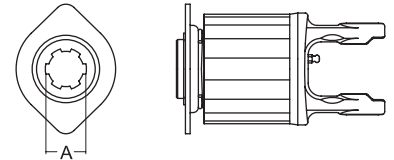

Stock Number	Type	Clutch Setting	Dim. "A" Bore
570-8306	Spring Lock	5300 in-lbs	1 3/8 x 6 Spl.

Interchanges with:

#### Bondioli & Pavesi 4 Series Walterscheid 2300 Series

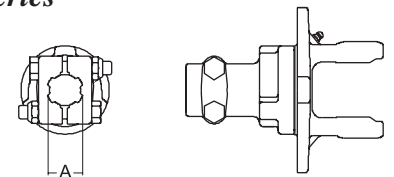

Clamp Yoke Stock Number	Overrunning Clamp Yoke Stock Number	Dim. "A" Bore
817-8406	818-8406	1 3/8" x 6 Spl.
817-8420		1 3/4" x 20 Spl.
817-8421	818-8421	1 3/8" x 21 Spl.

# Clutch Components

Interchanges with:

**Bondioli & Pavesi 4 Series**  
**Walterscheid 2300 Series**

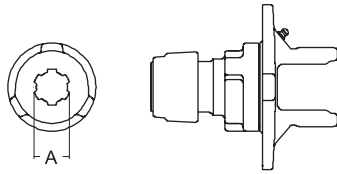

Auto Lok Stock Number	Overruning Stock Number	Dim. "A" Bore
820-8406	N/A	1 3/8" x 6 Spl.

Interchanges with:

**Bondioli & Pavesi 4 Series**  
**Walterscheid 2300 Series**

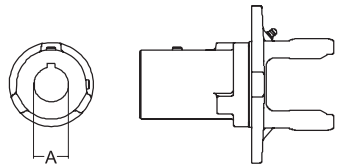

Round Bore Yoke Stock Number	Overruning Round Bore Yoke Stock Number	Dim. "A" Bore w / Keyway & Set-screw
825-8422	826-8422	1 3/8" Rd.

Interchanges with:

**Bondioli & Pavesi 4 Series**  
**Walterscheid 2300 Series**

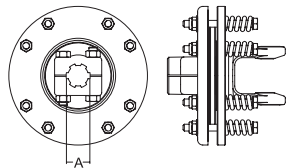

## Friction Clutch

Stock Number	Type	Clutch Setting	Dim. "A" Bore
560-8406*	Dbl.Clamp	8000 in-lbs	1 3/8 x 6 Spl.

\* Use Replacement Friction Disc 970-4140

Interchanges with:

**Bondioli & Pavesi 4 Series**  
**Walterscheid 2300 Series**

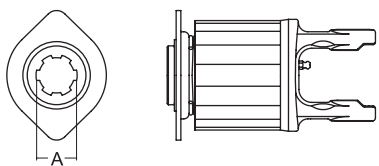

## Ratchet Clutch

Stock Number	Type	Clutch Setting	Dim. "A" Bore
570-8406	Spring Lock	8000 in-lbs	1 3/8 x 6 Spl.

Interchanges with:

**Bondioli & Pavesi 4 Series**  
**Walterscheid 2300 Series**

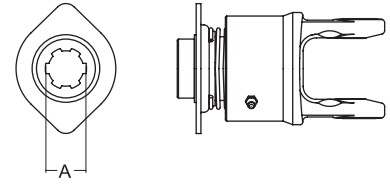

## Overrunning Clutch (Free-Wheel Clockwise)

Stock Number	Type	Clutch Setting	Dim. "A" Bore
580-8406	Spring-Lock	N/A	1 3/8" x 6 Spl.

Interchanges with:

**Bondioli & Pavesi 5 Series**

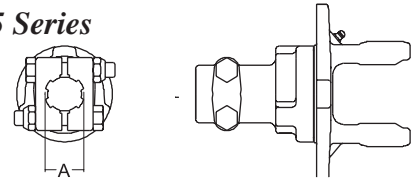

Clamp Yoke Stock Number	Overrunning Clamp Yoke Stock Number	Dim. "A" Bore
817-6506	818-6506	1 3/8" x 6 Spl.
817-6521	818-6521	1 3/8" x 21 Spl.

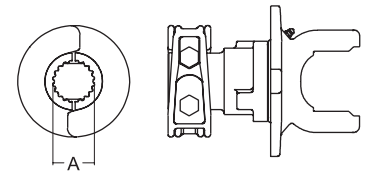

Clamp Yoke Stock Number	Overrunning Clamp Yoke Stock Number	Dim. "A" Bore
817-6520	818-6520	1 3/4" x 20 Spl.

Interchanges with:

**Bondioli & Pavesi 5 Series**

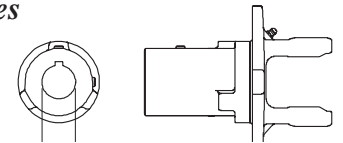

Round Bore Yoke Stock Number	Overrunning Round Bore Yoke Stock Number	Dim. "A" Bore
825-6522	826-6522	1 3/8" Rd.
825-6524	826-6524	1 1/2" Rd.

Interchanges with:

**Bondioli & Pavesi 5 Series**

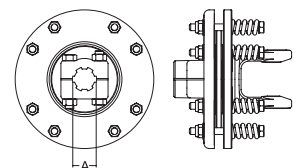

## Friction Clutch

Stock Number	Type	Clutch Setting	Dim. "A" Bore
560-6506*	Dbl.Clamp	8000 in-lbs	1 3/8 x 6 Spl.

\* Use Replacement Friction Disc 970-4140

# Clutch Components

Interchanges with:

**Bondioli & Pavesi 5 Series**

**Walterscheid 2300 Series**

## Overrunning Clutch

(Free-Wheel Clockwise)

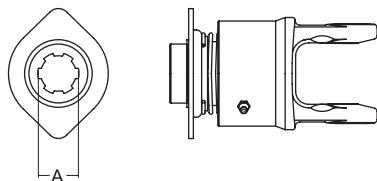

Stock Number	Type	Clutch Setting	Dim. "A" Bore
580-6506	Spring-Lock	N/A	1 3/8" x 6 Spl.

Interchanges with:

**Bondioli & Pavesi 5 Series**

## Ratchet Clutch

(3 & 4 Row)

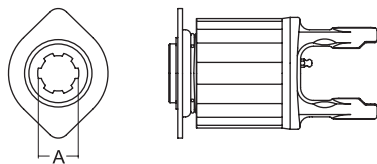

Stock Number	Type	Clutch Setting	Dim. "A" Bore
570-6506	Spring Lock	8000 in-lbs	1 3/8" x 6 Spl.

Interchanges with:

**Bondioli & Pavesi 6 Series**

**Walterscheid 220 Series**

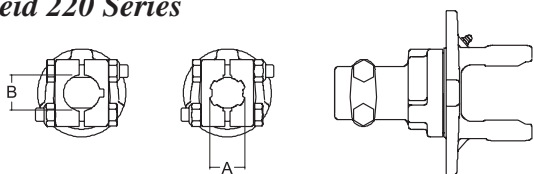

Clamp Yoke Stock Number	Overrunning Clamp Yoke Stock Number	Dim. "A" Bore	Dim. "B" Bore w / Keyway & Set-screw
817-8606	818-8606	1 3/8" x 6 Spl.	
817-8621	818-8621	1 3/8" x 21 Spl.	
817-8624			1 1/2" Rd.
817-8628	818-8628	1 3/4" x 6 Spl.	

Interchanges with:

**Bondioli & Pavesi 6 Series**

**Walterscheid 220 Series**

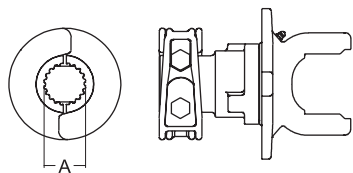

Clamp Yoke Stock Number	Overrunning Clamp Yoke Stock Number	Dim. "A" Bore
817-8620	818-8620	1 3/4" x 20 Spl.

Interchanges with:

**Bondioli & Pavesi 6 Series**

**Walterscheid 220 Series**

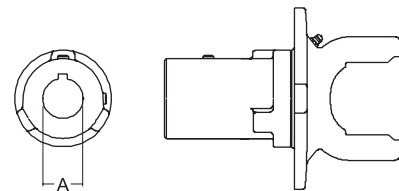

Round Bore Yoke Stock Number	Overrunning Round Bore Yoke Stock Number	Dim. "A" Bore w / Keyway & Set-screw
825-8622	826-8622	1 3/8" Rd.
825-8624		1 1/2" Rd.

Interchanges with:

**Bondioli & Pavesi 6 Series**

**Walterscheid 220 Series**

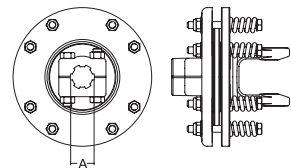

## Friction Clutch

Stock Number	Type	Clutch Setting	Dim. "A" Bore
560-8606*	Dbl.Clamp	11,125 in-lbs	1 3/8" x 6 Spl.
560-8620*	Dbl.Clamp	13,276 in-lbs	1 3/4" x 20 Spl.
560-8621*	Dbl.Clamp	13,276 in-lbs	1 3/8" x 21 Spl.

\* Use replacement Friction Disc 970-4160

## I-Type Friction Clutch

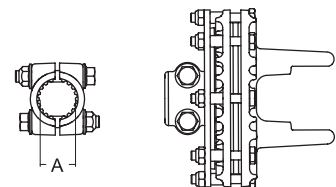

Stock Number	Type	Clutch Setting	Dim. "A" Bore
566-8606*	Dbl.Clamp	13,276 in-lbs	1 3/8" x 6 Spl.
566-8620*	Dbl.Clamp	13,276 in-lbs	1 3/4" x 20 Spl.
566-8621*	Dbl.Clamp	13,276 in-lbs	1 3/8" x 21 Spl.

\* Use replacement Friction Disc 970-1700

Interchanges with:

**Bondioli & Pavesi 6 Series**

**Walterscheid 220 Series**

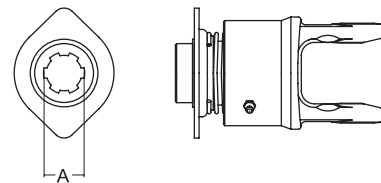

## Overrunning Clutch

(Free-Wheel Clockwise)

Stock Number	Type	Clutch Setting	Dim. "A" Bore
580-8606	Spring Lock	N/A	1 3/8" x 6 Spl.

# Clutch Components

Interchanges with:

## Bondioli & Pavesi 8 Series

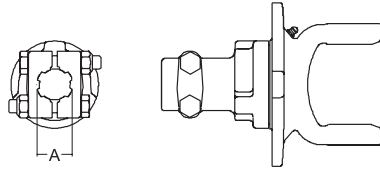

Clamp Yoke Stock Number	Overrunning Clamp Yoke Stock Number	Dim. "A" Bore
817-6806	818-6806	1 3/8" x 6 Spl.
817-6821	818-6821	1 3/4" x 21 Spl.

Interchanges with:

## Bondioli & Pavesi 8 Series

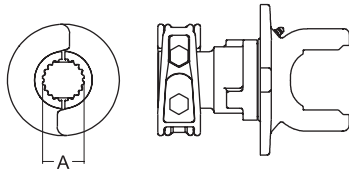

Clamp Yoke Stock Number	Overrunning Round Bore Yoke Stock Number	Dim. "A" Bore
817-6820	818-6820	1 3/4" x 20 Spl.
817-6828	818-6828	1 3/4" x 6 Spl.

Interchanges with:

## Bondioli & Pavesi 8 Series

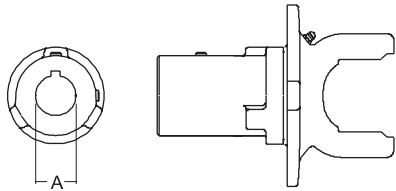

Round Bore Yoke Stock Number	Overrunning Round Bore Yoke Stock Number	Dim. "A" Bore w / Keyway & Set-screw
825-6822	826-6822	1 3/8" Rd.

Interchanges with:

## Walterscheid 2400 Series

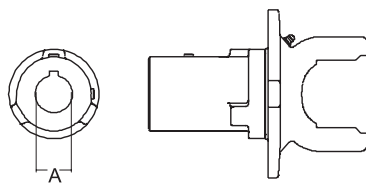

Round Bore Yoke Stock Number	Overrunning Round Bore Yoke Stock Number	Dim. "A" Bore w / Keyway & Set-screw
825-7622	826-7622	1 3/8" Rd.
825-7628	826-7628	1 3/4" Rd.

Interchanges with:

## Walterscheid 2400 Series

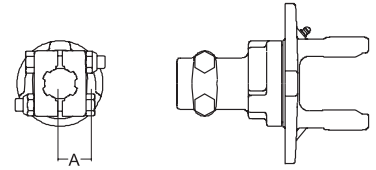

Clamp Yoke Stock Number	Overrunning Clamp Yoke Stock Number	Dim. "A" Bore
817-7606	818-7606	1 3/8" x 6 Spl.
817-7621	818-7621	1 3/8" x 21 Spl.

Interchanges with:

## Walterscheid 2400 Series

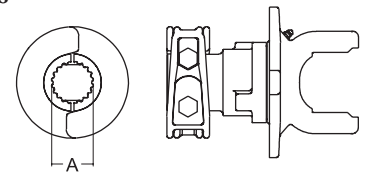

Clamp Yoke Stock Number	Overrunning Round Bore Yoke Stock Number	Dim. "A" Bore
817-7620	818-7620	1 3/4" x 20 Spl.

Interchanges with:

## Walterscheid 2400 Series

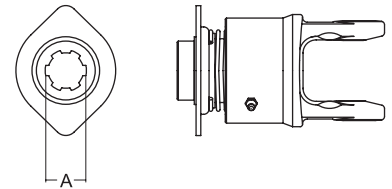

### Overrunning Clutch

(Free-Wheel Clockwise)

Stock Number	Type	Clutch Setting	Dim. "A" Bore
580-7606	Spring Lock	N/A	1 3/8" x 6 Spl.

Interchanges with:

## Walterscheid 2400 Series

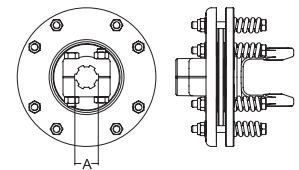

### Friction Clutch

Stock Number	Type	Clutch Setting	Dim. "A" Bore
560-7606*	Double Clamp	13,276 in-lbs	1 3/8" x 6 Spl.
560-7620*	Double Clamp	13,276 in-lbs	1 3/4" x 20 Spl.
560-7621*	Double Clamp	13,276 in-lbs	1 3/8" x 21 Spl.

\* Use replacement Friction Disc 970-4160

# Clutch Components

Interchanges with:  
**Walterscheid 2500 Series**

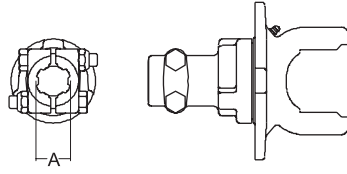

Clamp Yoke Stock Number	Overrunning Clamp Yoke Stock Number	Dim. "A" Bore
817-7906	818-7906	1 3/8" x 6 Spl.
817-7921	818-7921	1 3/8" x 21 Spl.

Interchanges with:  
**Walterscheid 2500 Series**

**Overrunning Clutch**  
(Free-Wheel Clockwise)

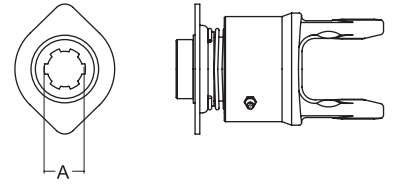

Stock Number	Type	Clutch Setting	Dim. "A" Bore
580-7906	Slide Lock	N/A	1 3/8" x 6 Spl.
580-7920	Slide Lock	N/A	1 3/4" x 20 Spl.
580-7921	Dbl. Clamp	N/A	1 3/8" x 21 Spl.

Interchanges with:  
**Walterscheid 2500 Series**

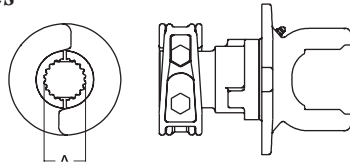

Clamp Yoke Stock Number	Overrunning Clamp Yoke Stock Number	Dim. "A" Bore
817-7920	818-7920	1 3/4" x 20 Spl.
817-7928	818-7928	1 3/4" x 6 Spl.

Interchanges with:  
**Walterscheid 2500 Series**

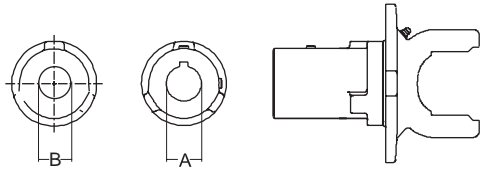

Round Bore Yoke Stock Number	Overrunning Round Bore Yoke Stock Number	Dim. "A" Bore w / Keyway & Set-screw	Dim. "B" Bore with 3/8" Pinhole
825-7922	826-7922	1 3/8" Rd.	
825-7928	826-7928	1 3/4" Rd.	
827-7932			2" Rd.

Interchanges with:  
**Walterscheid 2500 Series**

**Friction Clutch**

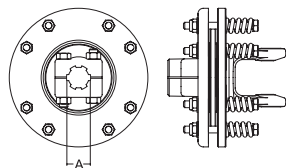

Stock Number	Type	Clutch Setting	Dim. "A" Bore
560-7906	Dbl. Clamp	13,276 in-lbs	1 3/8" x 6 Spl.
560-7920	Dbl. Clamp	13,276 in-lbs	1 3/4" x 20 Spl.
560-7921	Dbl. Clamp	13,276 in-lbs	1 3/8" x 21 Spl.

# Clutch Components

## Universal Friction Clutch

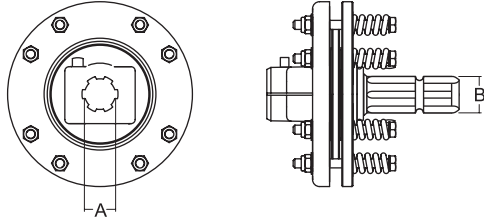

Stock Number	Dim "A"	Clutch Setting	Dim. "B" Bore
560-6006*	1 3/8" x 6 Spl.	8000 in lbs	1 3/8" x 6 Spl.
560-6020*	1 1/4" Rd.	8000 in lbs	1 3/8" x 6 Spl.
560-6022*	1 3/8" Rd.	8000 in lbs	1 3/8" Rd.
560-6606*	1 3/8" x 6 Spl.	6675 in lbs	1 3/8" x 6 Spl.
560-0622*	1 3/8" Rd.	8000 in lbs	1 3/8" x 6 Spl.
560-1122**	1 3/8" Rd.	11,063 in lbs	1 3/8" x 6 Spl.
560-1124**	1 3/8" x 6 Spl.	11,063 in lbs	1 3/8" x 6 Spl.

\* Use replacement friction disc 970-4140  
 \*\* Use replacement friction disc 970-4160

## Friction Disc

\* for 7" Torqmaster Clutch Paks  
 \*\* for 9" Torqmaster Clutch Paks

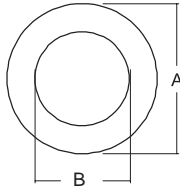

Stock Number	Dim. "A" O.D.	Dim. "B" Bore
970-7000*	6.20"	3.89"
970-9000**	7.95"	5.5"
970-0153	6.02"	3.58"
970-4140	5.5"	3.35"
970-4160	6.4"	3.82"
970-6000	5.25"	3.5"

NOTE: Quantity of required discs varies with stock number - check with customer service for correct amount

## Overrunning Clutch Repair Kit for 7" and 9" Torqmaster Clutch Paks



Stock Number	Content
980-7000	(1) Overrunning Collar (2) Dogs (2) Leaf Springs (1) Wave Spring (1) Washer (1) Retaining Ring (1) Assembly / Disassembly Instructions

## Spring 7" and 9" for Torqmaster Clutch Paks

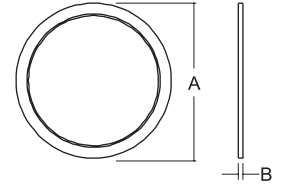

Stock Number	Dim. "A" O.D.	Dim. "B" Thickness
987-9000*	6.188"	.163"
98712000*	6.188"	.177"
98715000*	6.188"	.185"
98718000*	6.188"	.189"
98910000**	8.00"	.185"
98915000**	7.81"	.169"
98918000**	7.87"	.189"
98921000**	7.75"	.189"

\* for 7" Torqmaster Clutch Paks  
 \*\* for 9" Torqmaster Clutch Paks

## Separator Plate 7" and 9" for Torqmaster Clutch Paks

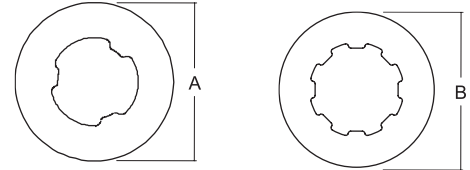

Separator Plate Stock Number	Overrunning Separator Plate Stock Number	Dim. "A" O.D.	Dim. "B" O.D.
990-7000*		6.20"	
	991-7000*		6.20"
990-9000**		8.07"	
	991-9000**		8.07"

\* Use on 7" Torqmaster  
 \*\* Use on 9" Torqmaster

## Overrunning Adapter Kit for Torqmaster Clutch Yoke

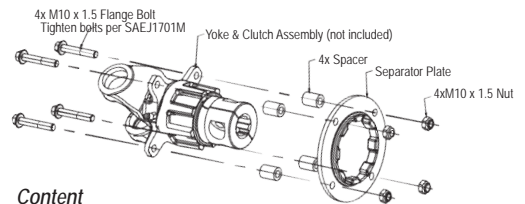

Stock Number	Content
19-16699	(1) Separator Plate (4) Stand Off (4) Bolt (4) Lock Nut (1) Assembly Instructions

NOTE: Enables overrunning function without the use of clutch pak

# Replacement Clutches

## ● BALL SHEAR ●

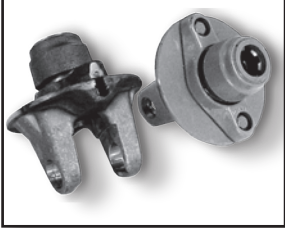

**APPLICATIONS:** SPREADERS, ROTARY CUTTERS, BALERS, GRAIN CARTS, GRAIN AUGERS, SNOWBLOWERS, FORAGE BLOWERS

**BENEFITS:** MINIMAL MAINTENANCE; NO DAMAGING HEAT GENERATION FOR HIGHER PRODUCTIVITY; REPEATABLE OVERLOAD SETTING; SMOOTH DISENGAGED OPERATION - NO DAMAGING TORQUE SPIKES.

## ● RATCHET ●



**APPLICATIONS:** HAY TEDDERS, ROUND BALERS

**BENEFITS:** REPEATABLE OVERLOAD SETTING; TORQUE PULSES WHILE SLIPPING AIDS IN DISLODGING PLUGS FOR INCREASED PRODUCTIVITY; MINIMAL MAINTENANCE; AUDIBLE OPERATOR NOTIFICATION; COMPACT 4" (102 MM).

## ● UNIVERSAL/FRICTION ●

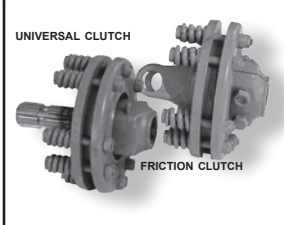

**APPLICATIONS:** MOWER CONDITIONERS, ROTARY CUTTERS, BALERS, SHREDDERS, SNOWBLOWERS, SPREADERS, GRAIN CARTS, MIXERS

**BENEFITS:** CORROSION RESISTANT FRICTION DISCS; MINIMAL MAINTENANCE; SMOOTH OPERATION - NO DAMAGING TORQUE SPIKES; TORQUE CARRYING CAPABILITY WHILE SLIPPING AIDS IN DISLODGING PLUGS FOR INCREASED PRODUCTIVITY.

## ● I-TYPE FRICTION ●



**APPLICATIONS:** MOWER CONDITIONERS, ROTARY CUTTERS, BALERS, SHREDDERS, SNOWBLOWERS, SPREADERS, GRAIN CARTS, MIXERS

**BENEFITS:** IMPLEMENT OVERLOAD PROTECTION; ISOLATES AND DISSIPATES HEAT MINIMIZING DOWNTIME FOR HIGHER PRODUCTIVITY; CORROSION RESISTANT FRICTION DISCS; OPTIMIZED DESIGN AFFORDS MORE RELIABLE TORQUE SETTING; MINIMAL MAINTENANCE; SMOOTH OPERATION, NO DAMAGING TORQUE SPIKES; TORQUE TRANSMISSION WHILE SLIPPING AIDS IN DISLODGING PLUGS FOR INCREASED PRODUCTIVITY.

## ● OVERRUNNING ●

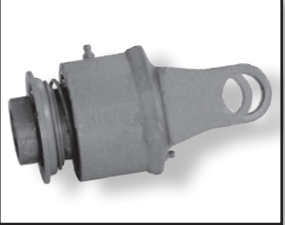

**APPLICATIONS:** GRAIN CARTS, SPREADERS, MIXERS, SHREDDERS, MOWER CONDITIONERS, ROTARY CUTTERS

**BENEFITS:** LOW-MAINTENANCE; ALLOWS INERTIA FROM IMPLEMENT TO DISSIPATE WITHOUT PUTTING LOAD BACK THROUGH THE TRACTOR OR SYSTEM.

## ● TORQMASTER ●



**APPLICATIONS:** SPREADERS, ROTARY CUTTERS, SHREDDERS, BALERS, GRAIN CARTS, SNOWBLOWERS, MOWER CONDITIONERS, MIXERS

**BENEFITS:** IMPLEMENT OVERLOAD PROTECTION; MINIMAL MAINTENANCE; ISOLATES AND DISSIPATES HEAT - MINIMIZING DOWNTIME FOR HIGHER PRODUCTIVITY; REPEATABLE OVERLOAD SETTING; CORROSION RESISTANT FRICTION DISCS; TORQUE CARRYING CAPABILITY WHILE SLIPPING AIDS IN DISLODGING PLUGS FOR INCREASED PRODUCTIVITY.

# Replacement Clutches

• GENUINE WEASLER. . . LEADING PROVIDER TO THE AFTERMARKET •

- MAINTENANCE FREE - unlike other aftermarket options
- 10X LONGER LIFE than Radial Pin-style Clutch
- DIRECT BOLT ON - no modification necessary
- Design minimizes damaging torque spikes and heat

• "TORQUE BOOST" option available

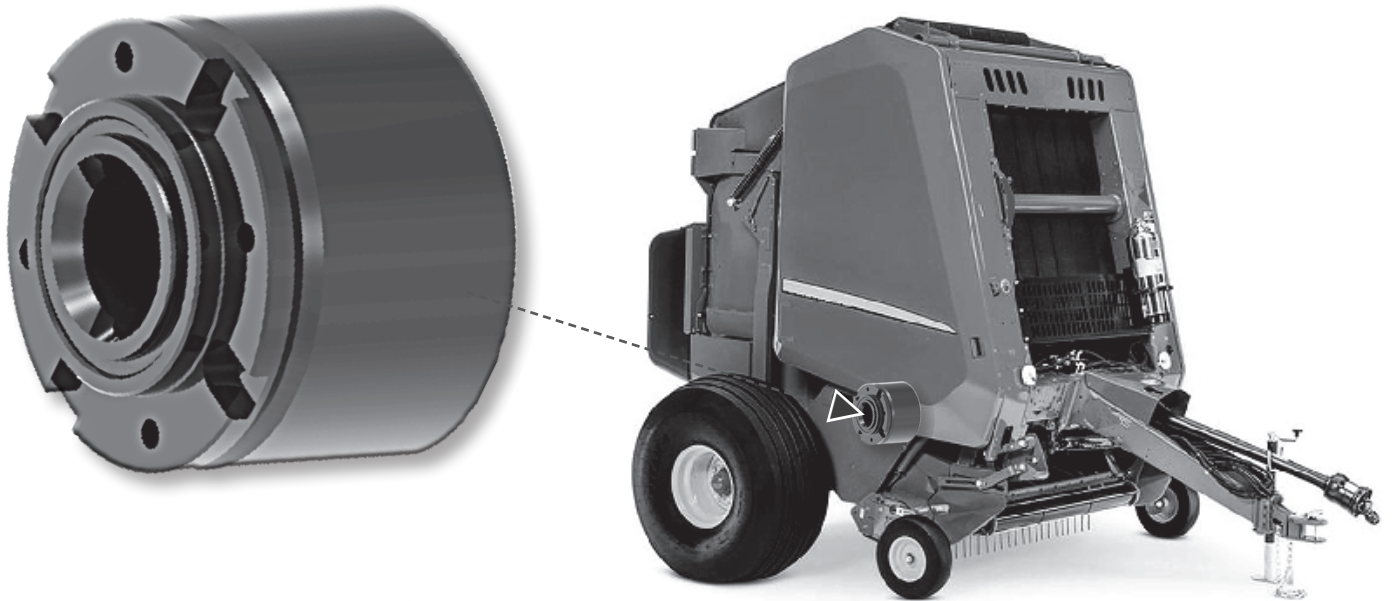

• AUTOMATIC PICK-UP CLUTCH REPLACEMENTS •



1-1/2" HEX

**STANDARD Automatic Clutch 1 - 1/2" Hex Bore • 700 NM**

**Part #: 59207024 Interchanges with:**

**JOHN DEERE MODELS:** 435; 445; 447; 448; 449; 456; 457; 458; 458S; 459; 459 Silage Special; 466; 467; 468; 468S; 469; 469 Premium; 469 Silage Special; 546; 547; 556; 557; 558; 559; 559 Silage Special; 566; 567; 568; 569; 569 Premium; 569 Silage Special

20% BOOST IN PICK-UP FEEDING PERFORMANCE

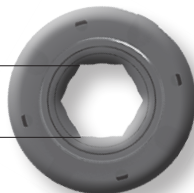

1-1/2" HEX

**"TORQUE BOOST" - Automatic Clutch - 1 - 1/2" Hex Bore • 850 NM**

**Part #: 59208524 Interchanges with:**

**JOHN DEERE MODELS:** 435; 445; 447; 448; 449; 456; 457; 458; 458S; 459; 459 Silage Special; 466; 467; 468; 468S; 469; 469 Premium; 469 Silage Special; 546; 547; 556; 557; 558; 559; 559 Silage Special; 566; 567; 568; 569; 569 Premium; 569 Silage Special

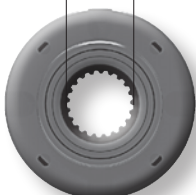

1-3/8" 21 Spl.

**"PRECUTTER" Automatic Clutch - 1-3/8" x 21 Spline Bore • 850 NM**

**Part #: 59208521 Interchanges with:**

**JOHN DEERE MODELS:** 640A; 640B; 645; 645A; 645B

**JOHN DEERE MODELS with Precutter Pick Up option:** 460M; 460R; 560M; 560R







## Aftermarket Product Guide



# Sprockets, Hubs and Pulleys

# SPROCKETS•HUBS•PULLEYS

## WELDING INSTRUCTIONS:

- > Insert hub in sprocket plate or pulley blank
- > Hold the parts in place with a C-clamp
- > Tack weld in two places
- > Remove C-clamp and weld continuously around hub. Always weld on larger side of hub, except on smaller sprockets where the weld may interfere with chain clearance.

## USE OF SPROCKET, HUB, & PULLEY NUMBERING SYSTEM:

### Sprocket # Identification Example:

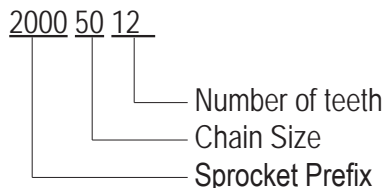

### Hub # Identification Example:

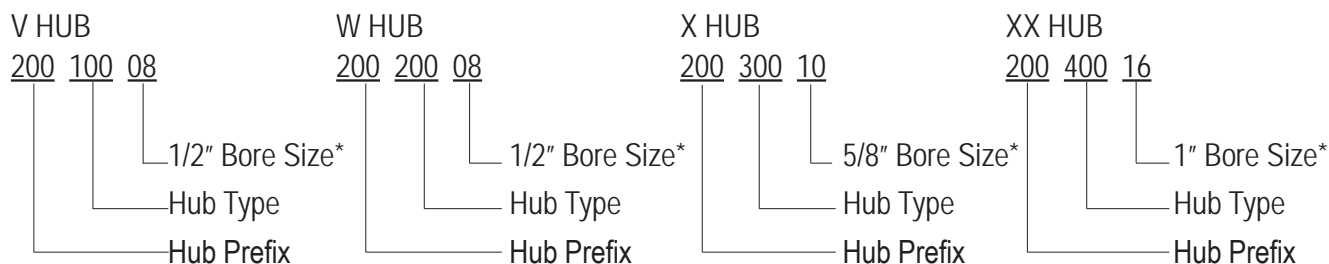

\* (Expressed in 1/16th inches)

# Sprockets

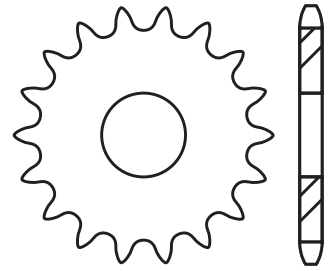

## 35 Chain

### Fits V Series Hub

Stock Number	Teeth	Outside Diameter
20003515	15	2"
20003519	19	2 1/2"
20003520	20	2 5/8"

### Fits W Series Hub

Stock Number	Teeth	Outside Diameter
20003522	22	2 13/16"
20003523	23	2 15/16"
20003525	25	3 3/16"
20003529	29	3 11/16"
20003530	30	3 13/16"
20003532	32	4 1/16"
20003535	35	4 5/16"
20003536	36	4 1/2"
20003540	40	4 15/16"

Stock Number	Teeth	Outside Diameter
20003545	45	5 9/16"
20003548	48	5 15/16"
20003560	60	7 5/16"
20003572	72	8 3/4"
20003584	84	10 1/4"
20003596	96	11 5/8"

## 40 Chain

### Fits V Series Hub

Stock Number	Teeth	Outside Diameter
20004012	12	2 3/16"
20004013	13	2 1/4"
20004014	14	2 7/16"
20004015	15	2 5/8"

### Fits X Series Hub

Stock Number	Teeth	Outside Diameter
20004020	20	3 7/16"
20004021	21	3 5/8"
20004022	22	3 3/4"
20004023	23	4"
20004024	24	4 1/16"
20004025	25	4 3/16"
20004026	26	4 3/8"
20004027	27	4 1/2"
20004028	28	4 11/16"
20004029	29	4 3/4"
20004030	30	5 1/16"
20004032	32	5 3/8"

Stock Number	Teeth	Outside Diameter
20004035	35	5 11/16"
20004036	36	6"
20004038	38	6 1/4"
20004040	40	6 5/8"
20004045	45	7 3/8"
20004048	48	7 7/8"
20004054	54	8 7/8"
20004060	60	9 3/16"
20004072	72	11 3/16"
20004080	80	12 15/16"
20004096	96	15 1/2"

### Fits W Series Hub

Stock Number	Teeth	Outside Diameter
20004016	16	2 13/16"
20004017	17	3"
20004018	18	3 1/8"
20004019	19	3 5/16"

\* NOTE: All measurements of outside diameters are approximate.

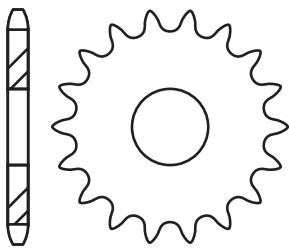

# Sprockets

## 50 Chain

### Fits V Series Hub

Stock Number	Teeth	Outside Diameter
20005010	10	2 1/4"
20005011	11	2 1/2"

### Fits W Series Hub

Stock Number	Teeth	Outside Diameter
20005012	12	2 3/4"
20005013	13	2 7/8"
20005014	14	3 1/16"
20005015	15	3 1/4"
20005016	16	3 7/16"

### Fits X Series Hub

Stock Number	Teeth	Outside Diameter
20005017	17	3 11/16"
20005018	18	3 7/8"
20005019	19	4 1/8"
20005020	20	4 3/8"
20005021	21	4 9/16"
20005022	22	4 3/4"
20005023	23	4 15/16"
20005024	24	5 1/8"
20005026	26	5 1/2"
20005027	27	5 11/16"
20005028	28	5 7/8"
20005029	29	6 1/8"
20005030	30	6 5/16"
20005031	31	6 1/2"
20005032	32	6 3/4"
20005033	33	6 7/8"
20005034	34	7 1/16"

Stock Number	Teeth	Outside Diameter
20005035	35	7 1/4"
20005036	36	7 9/16"
20005037	37	7 11/16"
20005038	38	7 15/16"
20005039	39	8 1/8"
20005040	40	8 5/16"
20005041	41	8 1/2"
20005043	43	8 7/8"
20005044	44	9 1/16"
20005048	48	9 7/8"
20005054	54	11 1/16"
20005060	60	12 5/16"
20005072	72	14 5/8"
20005080	80	16 1/4"
20005096	96	19 7/16"

## 60 Chain

### Fits V Series Hub

Stock Number	Teeth	Outside Diameter
20006009	9	2 1/2"
20006010	10	2 3/4"

### Fits X Series Hub

Stock Number	Teeth	Outside Diameter
20006015	15	4"
20006016	16	4 1/4"
20006017	17	4 1/2"
20006018	18	4 11/16"
20006019	19	5"
20006020	20	5 1/8"
20006021	21	5 1/2"
20006022	22	5 11/16"
20006023	23	5 15/16"
20006024	24	6 1/8"
20006025	25	6 3/8"
20006026	26	6 5/8"
20006027	27	6 7/8"
20006028	28	7 1/8"
20006029	29	7 3/8"
20006030	30	7 5/8"

Stock Number	Teeth	Outside Diameter
20006031	31	7 3/4"
20006032	32	8"
20006033	33	8 5/16"
20006034	34	8 9/16"
20006035	35	8 3/4"
20006036	36	9"
20006038	38	9 7/8"
20006042	42	10 1/2"
20006045	45	11 3/16"
20006048	48	11 7/8"
20006050	50	12 3/8"
20006054	54	13 1/4"
20006060	60	14 3/4"
20006072	72	17 5/8"
20006080	80	19 1/2"

### Fits W Series Hub

Stock Number	Teeth	Outside Diameter
20006011	11	3"
20006012	12	3 1/4"
20006013	13	3 1/2"
20006014	14	3 3/4"

\* NOTE: All measurements of outside diameters are approximate.

# Sprockets

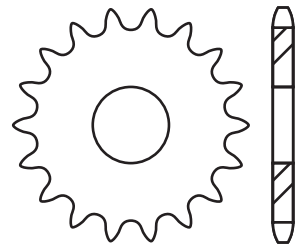

## 80 Chain

### Fits W Series Hub

Stock Number	Teeth	Outside Diameter
20008009	9	3 1/4"
20008010	10	3 5/8"
20008011	11	4"

### Fits X Series Hub

Stock Number	Teeth	Outside Diameter
20008012	12	4 3/8"
20008013	13	4 5/8"
20008014	14	5"
20008015	15	5 1/4"
20008016	16	5 5/8"
20008017	17	6"
20008018	18	6 5/16"
20008019	19	6 9/16"
20008020	20	6 15/16"
20008021	21	7 1/4"
20008022	22	7 9/16"
20008024	24	8 3/16"
20008025	25	8 1/2"

Stock Number	Teeth	Outside Diameter
20008026	26	8 13/16"
20008027	27	9 3/16"
20008028	28	9 3/8"
20008029	29	9 3/4"
20008030	30	10 1/8"
20008032	32	10 13/16"
20008033	33	11 1/8"
20008034	34	11 3/8"
20008035	35	11 5/8"
20008036	36	12"
20008040	40	13 5/16"
20008045	45	14 7/8"
20008048	48	15 7/8"

\* NOTE: All measurements of outside diameters are approximate.

## Roller Chain Idler Sprockets

---

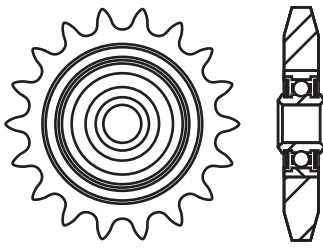

### 40 Chain

Stock Number	No. of Teeth	Bore Size
20401708	17	1/2"
20401710	17	5/8"

### 50 Chain

Stock Number	Teeth	Outside Diameter
20501308	13	1/2"
20501310	13	5/8"
20501508	15	1/2"
20501510	15	5/8"
20501708	17	1/2"
20501710	17	5/8"

### 60 Chain

Stock Number	Teeth	Outside Diameter
20601108	11	1/2"
20601110	11	5/8"
20601308	13	1/2"
20601310	13	5/8"
20601508	15	1/2"
20601510	15	5/8"

### 80 Chain

Stock Number	No. of Teeth	Bore Size
20801112	11	3/4"

## Ag Idler Chain Series

---

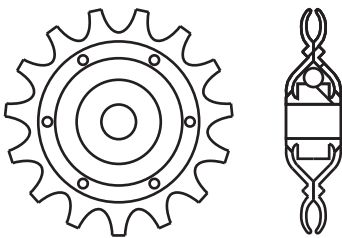

Stock Number	Chain Size	No. of Teeth	Bore Size
25401808	40 or 41	18	1/2"
25401810	40 or 41	18	5/8"
25501708	50	17	1/2"
25501710	50	17	5/8"
25601508	60	15	1/2"
25601510	60	15	5/8"

# Hubs

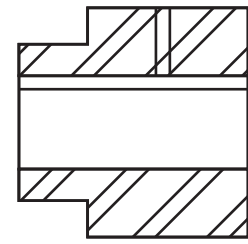
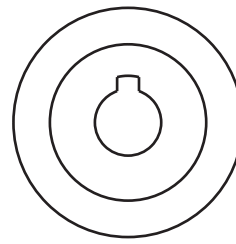

## V Series

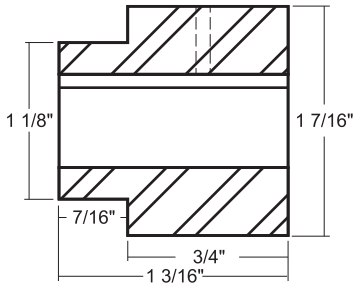

## W Series

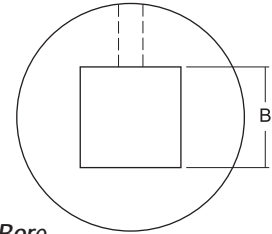
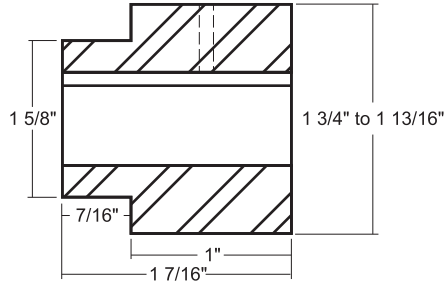

## Square Bore

with Set Screws

Stock Number	Dim "B"
2002S012	3/4"
2002S014	7/8"
2002S016	1"

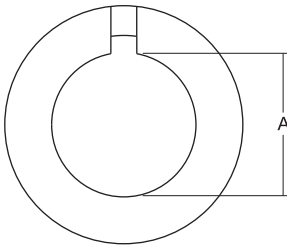

## Round Bore

with Keyway & Set Screws

Stock Number	Dim "A"
20010008	1/2"
20010009	9/16"
20010010	5/8"
20010011	11/16"
20010012	3/4"
20010013	13/16"
20010014	7/8"

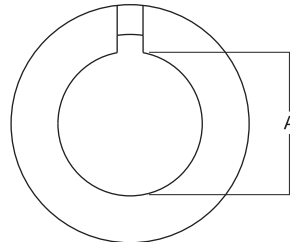

## Round Bore

with Keyway & Set Screws

Stock Number	Dim "A"
20020008	1/2"
20020009	9/16"
20020010	5/8"
20020011	11/16"
20020012	3/4"
20020013	13/16"
20020014	7/8"
20020015	15/16"
20020016	1"
20020017	1 1/16"
20020018	1 1/8"
20020019	1 3/16"
20020020	1 1/4"

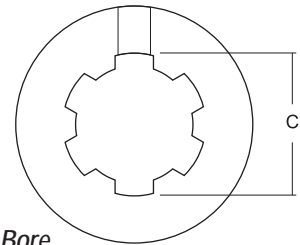

## Spline Bore

with Set Screw

Stock Number	Dim "C"
20021806	1 1/8" x 6
20022206	1 3/8" x 6
20022221	1 3/8" x 21

## Standard Keyway Sizes

BORE	KEYWAY SIZE
1/2" to 9/16"	1/8" x 1/16"
5/8" to 7/8"	3/16" x 3/32"
15/16" to 1 1/4"	1/4" x 1/8"
1 5/16" to 1 3/8"	5/16" x 5/32"
1 7/16" to 1 3/4"	3/8" x 3/16"
1 13/16" to 2 1/4"	1/2" x 1/4"
2 5/16" to 2 3/4"	5/8" x 5/16"
2 13/16" to 3"	3/4" x 3/8"
3 5/16" to 3 3/4"	7/8" x 7/16"
3 13/16" to 4 1/2"	1" x 1/2"

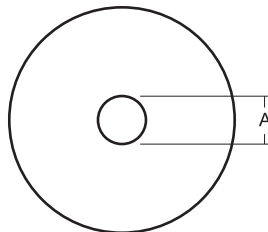

## Stock Bore

Stock Number	Dim "A"
20020000	1/2"

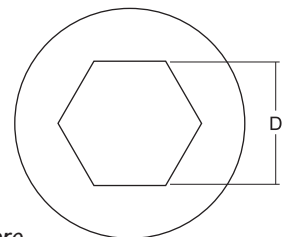

## Hex Bore

with Set Screws

Stock Number	Dim "D"
20021014	7/8"
20021016	1"
20021018	1 1/8"



# Hubs (cont'd.)

## X Series

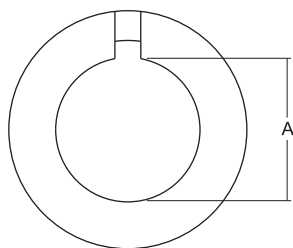
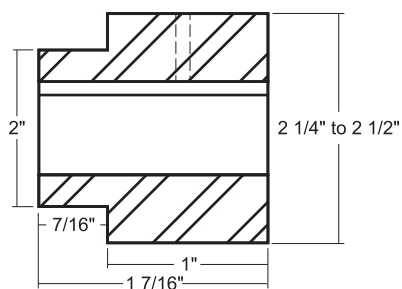

### Round Bore

with Keyway & Set Screws

Stock Number	Dim "A"
20030010	5/8"
20030011	11/16"
20030012	3/4"
20030013	13/16"
20030014	7/8"
20030015	15/16"
20030016	1"
20030017	1 1/16"
20030018	1 1/8"
20030019	1 3/16"
20030020	1 1/4"
20030021	1 5/16"
20030022	1 3/8"
20030023	1 7/16"
20030024	1 1/2"

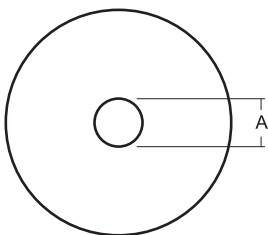

### Stock Bore

Stock Number	Dim "A"
20030000	5/8"

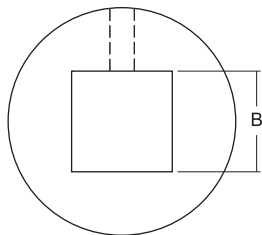

### Round Bore

with Keyway & Set Screws

Stock Number	Dim "B"
2003S012	3/4"
2003S014	7/8"
2003S016	1"
2003S018	1 1/8"
2003S020	1 1/4"

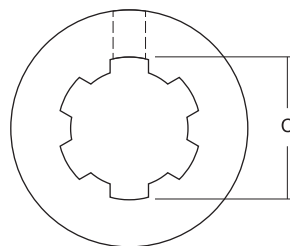

### Spline Bore

with Set Screw

Stock Number	Dim "C"
20031806	1 1/8"x 6 Spl.
20032206	1 3/8"x 6 Spl.
20032221	1 3/8"x 21 Spl.

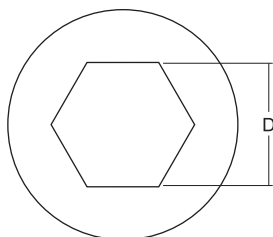

### Hex Bore

with Set

Stock Number	Dim "D"
20031014	7/8"
20031016	1"
20031018	1 1/8"

## XX Series

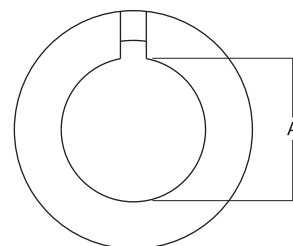
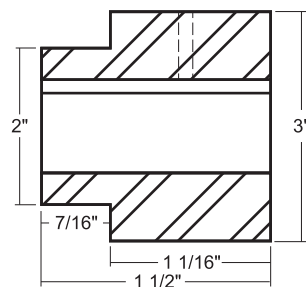

### Round Bore

with Keyway & Set Screws

Stock Number	Dim "B"
20040016	1"
20040020	1 1/4"
20040022	1 3/8"
20040024	1 1/2"
20040026	1 5/8"

# Pulleys

Fits A or B Groove V-Belts

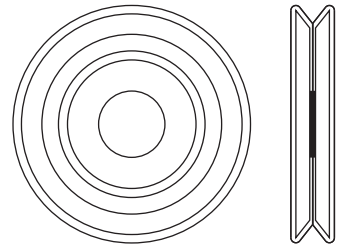

## Fits V Series Hub

Stock Number	Outside Diameter
21010025	2 1/2"
21010030	3"

## Fits W Series Hub

Stock Number	Outside Diameter
21020035	3 1/2"
21020040	4"
21020045	4 1/2"
21020050	5"
21020055	5 1/2"
21020060	6"
21020065	6 1/2"
21020070	7"

Stock Number	Outside Diameter
21020080	8"
21020090	9"
21020100	10"
21020110	11"
21020120	12"
21020140	14"
21020160	16"

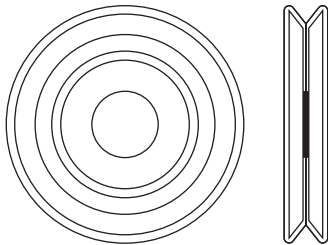

C — Section

## Fits W Series Hub

Stock Number	Outside Diameter
22030040	4"

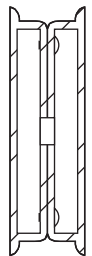
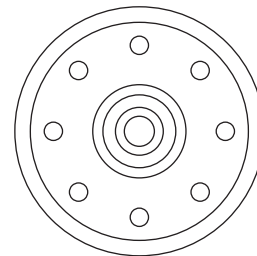
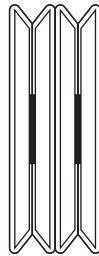
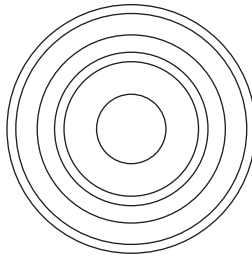

## Fits X Series Hub

Stock Number	Outside Diameter
22030060	6"
22030080	8"
22030100	10"
22030120	12"

## Fits W Series Hub

Double Groove

Stock Number	Outside Diameter
22040060	6"
22040100	10"
22040120	12"
22040140	14"

## Flat Belt Idler

Stock Number	Bore Size	Outside Diameter
23004008	1/2"	4"
23004010	5/8"	4"
23005008	1/2"	5"

### Pulley # Identification System

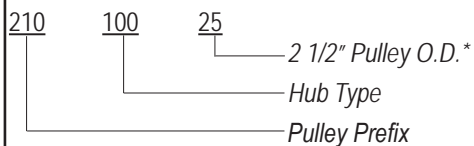

\*Expressed in inches

\*NOTE: All measurements of outside diameters are approximate.





**Weasler®**

## Aftermarket Product Guide



# Jaw Couplings

# Jaw Couplings

Interchanges with Lovejoy

## ROUND BORE

With Keyway

Stock Number	Bore Size "A"		O.D. Dim. "B"
507-9507	7/16"	w 1/8" KW	2.125"
507-9508	1/2"	w 1/8" KW	2.125"
507-9510	5/8"	w 3/16" KW	2.125"
507-9512	3/4"	w 3/16" KW	2.125"
507-9514	7/8"	w 3/16" KW	2.125"
507-9515	15/16"	w 1/4" KW	2.125"
507-9516	1"	w 1/4" KW	2.125"
507-9518	1 1/8"	w 1/4" KW	2.125"

\*These jaw coupling halves are ordered separately along with a spider insert to make a complete assembly.

TYPE L095

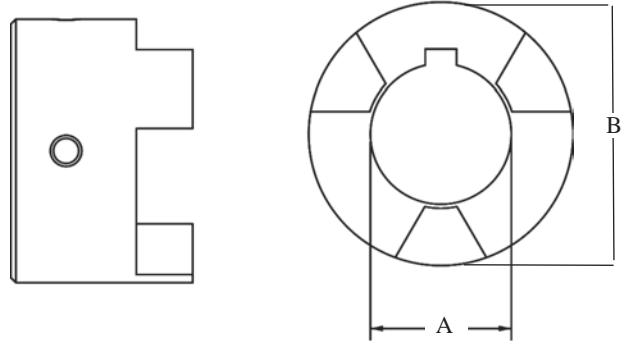

## Jaw Coupling Spider Insert

Stock Number	Type	
507-0750	L075	Solid Insert
507-0790	L090/L095	Hollow Insert

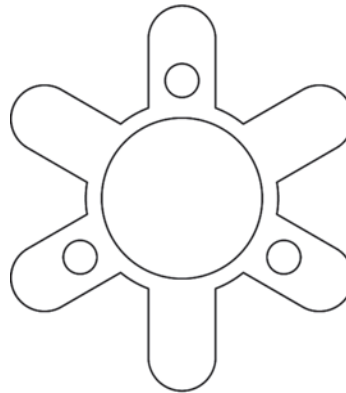

## Complete Jaw Coupler

Stock Number	Bore Size Dim. "A"	Bore Size Dim. "B"	Length Dim. "C"
512-7507	7/16" w 1/8" KW	3/4" w 3/16" KW	2.13"
512-7508	1/2" w 1/8" KW	3/4" w 3/16" KW	2.13"

TYPE L075

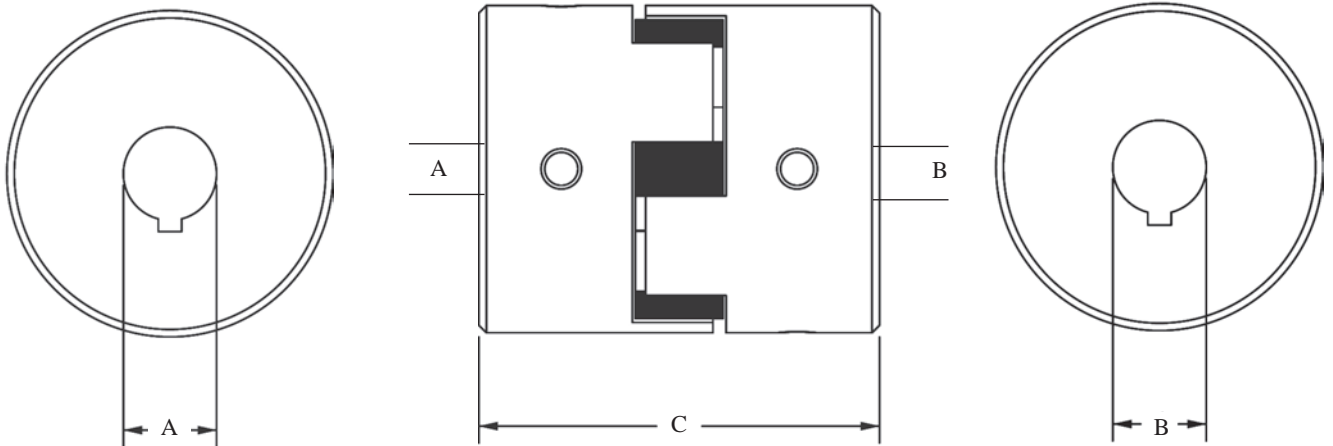

\*Used for the following applications:

\*Log Splitters \* Pumps \* Gear Boxes \* Compressors \* Blowers \* Mixers \* Conveyors



**Weasler**<sup>®</sup>

## Aftermarket Product Guide



# Merchandisers

# ALL-PURPOSE DRIVELINE DISPLAY UNIT

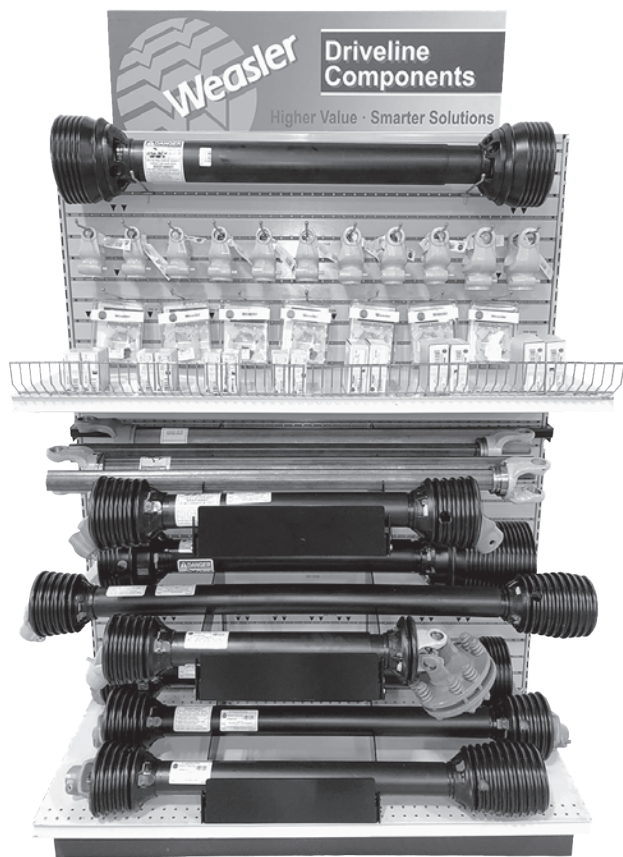

MERCHANDISERS

## ADVANTAGES FOR YOU...

- Racking unit uses existing Gondola Display
- Improved “Shop Ability”
- Drive increased sales
- Reduction in space
- Stimulates the question *“What’s New?”*

## ...AND YOUR CUSTOMER

- Visually inviting
- Product is available for inspection
- Drivelines are securely displayed on the unit
- Drivelines conveniently placed - no overhead lifting required
- Easy product handling for customer

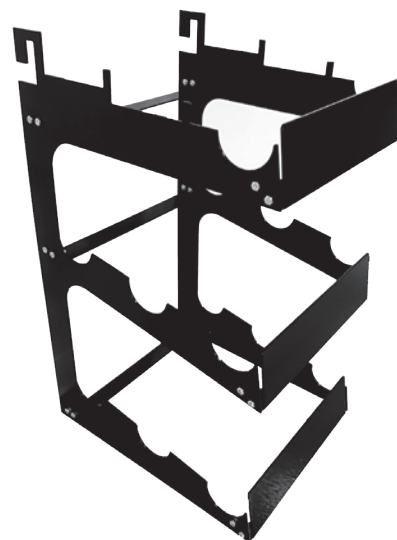

**DRIVELINE RACKING UNIT**  
**PART No. 16-17678**

# NORTH AMERICAN & METRIC DRIVELINES RACK DISPLAY

## RACK OPTION FOR: SMALL METRIC IMPLEMENT DRIVELINE

CONTAINS:		FOR:	
(2)	14006127	FERTILIZER SPREADER	
(1)	14006340	FINISHING MOWER	
(2)	14006436	5 FT. LIFT CUTTER	
(1)	14006442	6 FT. LIFT CUTTER	
(2)	14006448	ALL PURPOSE	
(1)	14006453	HD POST HOLE DIGGER	
(1)	14006542	6 FT. LIFT CUTTER	
(1)	14106438	PULL TYPE CUTTER W/FRICTION CLUTCH	
(1)	14307645	6 DISC MOWER W/OVERRUNNING CLUTCH	
(1)	12000009	A FRAME RACK	
(2)	12000009MH	METRIC HEADER	

**PART NO.: 12008600**

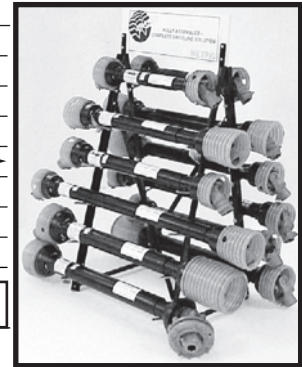

## RACK OPTION FOR: SMALL DOMESTIC/METRIC IMPLEMENT DRIVELINES

CONTAINS:		FOR:	
(1)	14000600	FINISHING MOWER DOMESTIC	
(1)	14000620	FERTILIZER SPREADER	
(1)	14001200	POST HOLE DIGGER DOMESTIC	
(1)	14001405	5 FT. CUTTER DOMESTIC	
(1)	14001406	6 FT. CUTTER DOMESTIC	
(1)	14003536	ALL PURPOSE DRIVELINE DOMESTIC	
(1)	14006127	FERTILIZER SPREADER	
(1)	14006340	FINISHING MOWER METRIC	
(1)	14006436	5 FT. CUTTER METRIC	
(1)	14006442	6 FT. CUTTER METRIC	
(1)	14006448	ALL PURPOSE DRIVELINE METRIC	
(1)	14006453	POST HOLE DIGGER METRIC	
(1)	12000009	A FRAME RACK	
(1)	12000009MH	METRIC HEADER	
(1)	12000009DH	DOMESTIC HEADER	

**PART NO.: 12008650**



## RACK OPTION FOR: SMALL DOMESTIC/METRIC MOWER DRIVELINES & CLUTCHES

CONTAINS:		FOR:	
(1)	14000600	FINISHING MOWER DOMESTIC	
(2)	14001404	4 FT. CUTTER DOMESTIC	
(2)	14001405	5 FT. CUTTER DOMESTIC	
(1)	14001406	6 FT. CUTTER DOMESTIC	
(1)	14006340	FINISHING MOWER METRIC	
(1)	14006432	4 FT. CUTTER METRIC	
(1)	14006436	5 FT. CUTTER METRIC	
(1)	14006442	6 FT. CUTTER METRIC	
(1)	14307645	DISC MOWER METRIC WITH OVERRUNNING CLUTCH	
(1)	560-6006	UNIVERSAL FRICTION CLUTCH 1-3/8" x 6 SPLINE	
(1)	560-6022	UNIVERSAL FRICTION CLUTCH 1-3/8" ROUND	
(1)	12000009	A FRAME RACK	
(1)	12000009MH	METRIC HEADER	
(1)	12000009DH	DOMESTIC HEADER	

**PART NO.: 12008700**

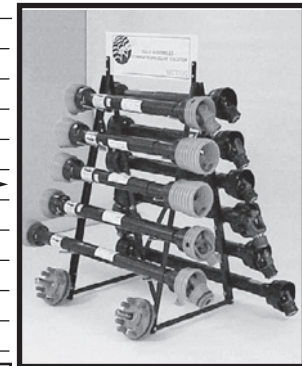

## RACK OPTION FOR: LARGE DOMESTIC/METRIC MOWER DRIVELINES & CLUTCHES

CONTAINS:		FOR:	
(1)	14000600	FINISHING MOWER DOMESTIC	
(1)	14001404	4 FT. CUTTER DOMESTIC	
(1)	14001405	5 FT. CUTTER DOMESTIC	
(1)	14001406	6 FT. CUTTER DOMESTIC	
(1)	14006340	FINISHING MOWER METRIC	
(1)	14006432	4 FT. CUTTER METRIC	
(1)	14006436	5 FT. CUTTER METRIC	
(1)	14006442	6 FT. CUTTER METRIC	
(1)	14307645	DISC MOWER METRIC WITH OVERRUNNING CLUTCH	
(1)	14505555	FLEXWING MOWER DOMESTIC WITH 80° CV	
(1)	14507955	FLEXWING MOWER METRIC WITH 80° CV	
(1)	560-6006	UNIVERSAL FRICTION CLUTCH 1-3/8" x 6 SPLINE	
(1)	560-6022	UNIVERSAL FRICTION CLUTCH 1-3/8" ROUND	
(1)	12000009	A FRAME RACK	
(1)	12000009MH	METRIC HEADER	
(1)	12000009DH	DOMESTIC HEADER	

**PART NO.: 12008750**

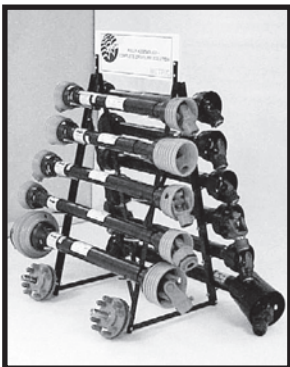

MERCHANDISERS



# NORTH AMERICAN DRIVELINE COMPONENT DISPLAY

MERCHANDISERS

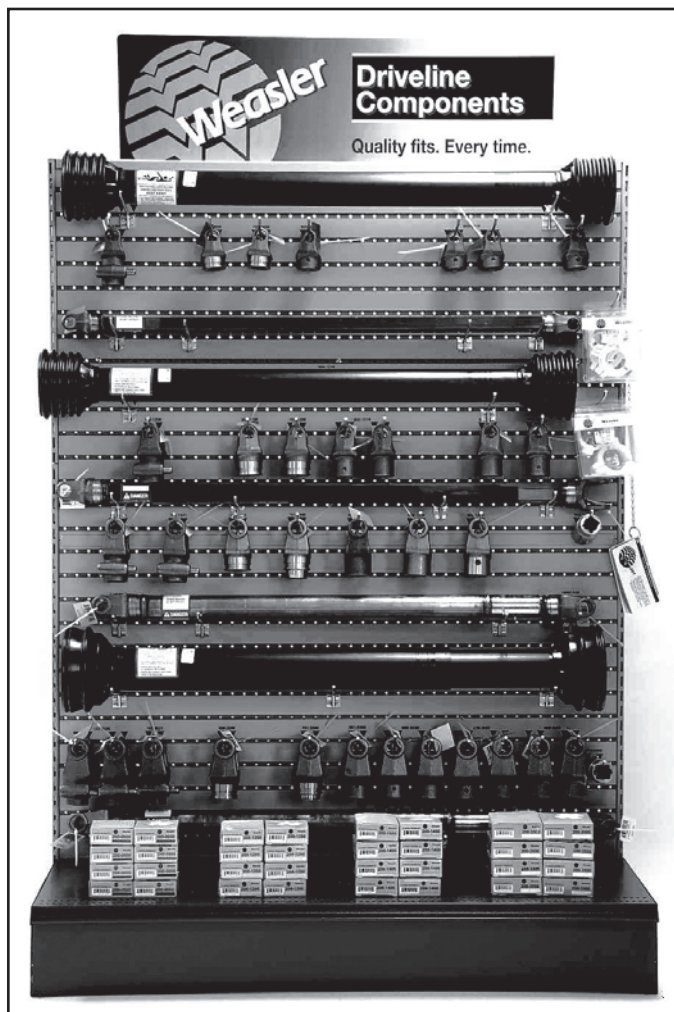

**Display Board  
No. 12001000**

The Weasler Display Center is a dealer merchandiser that makes selling easy. Most parts are on display for convenient visual inventory control as well as quick self-service for the customer.

**Display Board  
No. 12002000**

Includes the same product as No. 2001000, plus an assortment of tubing and shafting in 6' lengths

The 48" x 66" floor fixture contains an inventory of driveline components in the most popular sizes. Equivalents are available for most competitive brands.

<b>6 Series</b>		<b>35 Series</b>	
Quantity	Stock No	Quantity	Stock No
2	102-0606	2	102-3506
8	200-0600	1	102-3521
2	300-0600	8	200-3500
2	700-0600	1	300-3500
1	800-0612	1	500-3500
4	800-0616	1	701-3500
2	800-0620	2	800-3520
1	900-2548	2	800-3522
1	921-0600	2	800-3524
1	10000648	1	801-3506
1	11000648	1	900-2548
		1	921-1200
		1	10003548
		1	11003548
<b>12 Series</b>			
2	102-1206	Quantity	Stock No
8	200-1200	2	400-1214
2	300-1200	2	400-1618
2	700-1200	1	400-0019
4	800-1216	2	600-1618
1	800-1222	2	600-2022
2	806-1220	1	602-1400
1	900-2548	1	602-3500
1	921-1200		
1	10001248		
1	11001248		
		<b>Transparency ID System</b>	
		1	12002500
<b>14 Series</b>		<b>Header Board with Hardware</b>	
2	100-1421	1	12000001H
2	102-1406		
8	200-1400		
2	300-1400		
1	500-1400		
2	701-1400		
2	800-1420		
2	800-1422		
1	802-1422		
1	10001448		
1	11001448		

# NORTH AMERICAN DRIVELINE COMPONENT DISPLAY 44/55 SERIES

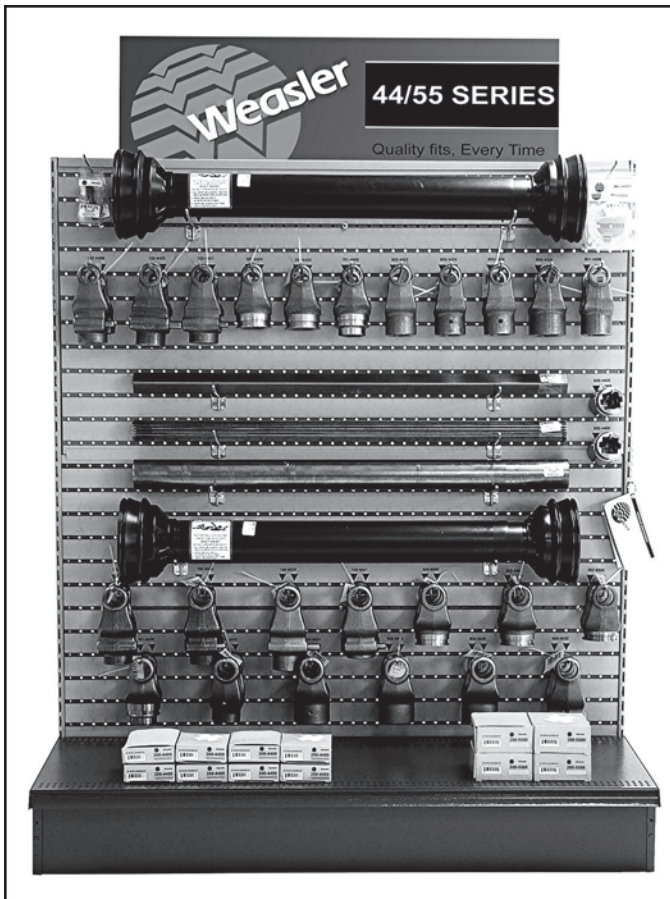

## Display Board No. 12004000

The Weasler Display Center is a dealer merchandiser that makes selling easy. Most parts are on display for convenient visual inventory control as well as quick self-service for the customer.

The 48" x 56" floor fixture contains an inventory of high horsepower driveline components in the most popular sizes. Equivalents are available for most competitive brands.

44 Series Quantity	Stock No
1	102-4406
1	102-4420
1	102-4421
8	200-4400
2	300-4400
2	500-4400
1	701-4400
1	800-4422
2	800-4424
1	800-4428
1	801-4406
2	902-3548
2	921-4400

55 Series	Stock No
2	102-5506
1	102-5520
1	102-5521
4	200-5500
2	300-5500
1	302-5500
1	701-5500
1	800-5522
1	800-5524
2	800-5528
1	800-5532

Locking Repair Kits	Stock No
1	13002006
1	13002020
1	13002021

Shafting	Stock No
1	404-0021
1	404-2720
1	604-4400

Transparency ID System	Stock No
1	12002500

Header Board with Hardware	Stock No
1	12000004H

MERCHANDISERS

# METRIC DRIVELINE COMPONENT DISPLAY

MERCHANDISERS

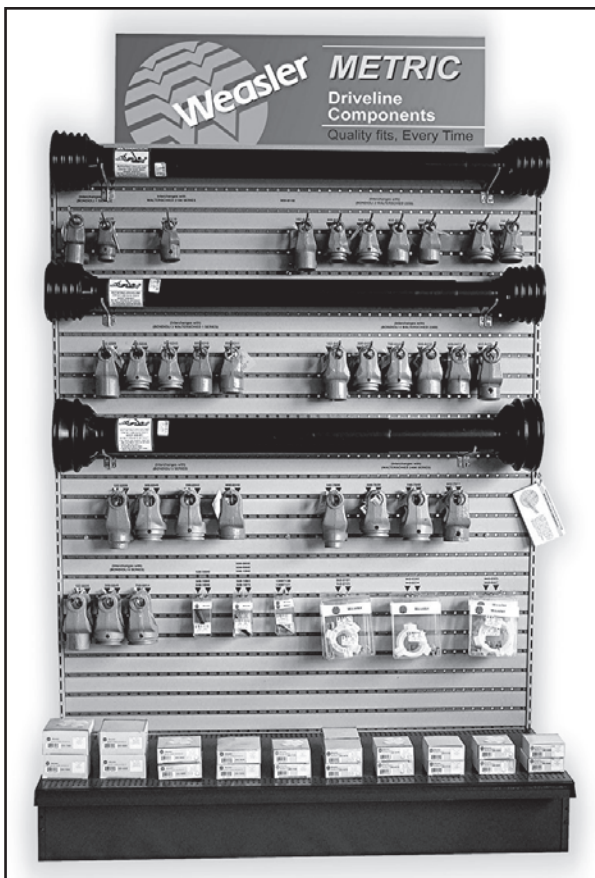

**Display Board  
No. 12008000**

The Weasler Display Center is a dealer merchandiser that makes selling easy. Most parts are on display for convenient visual inventory control as well as quick service for the customer.

The 48" x 66" floor fixture contains an inventory of the most popular sizes, including inner and outer profile tubes.

**Display Board  
No. 12008100**

The display board includes the items depicted by the display photo above. It does NOT include an assortment of inner and outer profile tubes.

Tractor Yoke		Outer Profile Tube	
Quant.	Stock No	Quant.	Stock No
1	102-6106	1	600-6133
1	102-6506	1	600-6236
1	102-7606	1	600-6343
1	102-8206	1	600-6552
1	102-8306	1	600-6654
1	102-8406	1	600-7130
1	102-8606	1	600-7241
		1	600-7548

Lock Yoke Repair Kit		Outer Profile Yoke	
1	13006121	1	700-6236
1	13007138	1	700-6343

Cross & Bearing Kit			
2	200-6154	1	700-6443
2	200-6580	1	700-6552
2	200-6806	1	700-6654
2	200-7155	1	700-7241
2	200-7676	1	700-7648

		Implement Yoke	
2	200-7989	1	800-6510
2	200-8261	1	800-8208
2	200-8370	1	800-8210
2	200-8474	1	800-8310
2	200-8692	1	800-8311

Inner Profile Yoke		Guard	
1	300-6126	1	800-8410
1	300-6229	1	800-8411
1	300-6336	1	802-7110
1	300-6436	1	802-7611
1	300-6545	1	802-8435
1	300-6645		
1	300-7234	2	900-2548
1	300-7639	1	902-3548

Inner Profile Tube		Bearing Kit (2 per Kit)	
1	400-6126	1	961-5005
1	400-6229	1	961-5029
1	600-6236	1	961-2502
1	400-6436	1	961-2534
1	400-6545	1	961-3525
1	400-7234	1	961-3567
1	400-7539		

Roll Pin		Transparency ID System No. 12008500	
1	508-0850		
1	508-0860		
1	508-0880		
1	508-1060		
1	508-1065		
1	508-1075		
1	508-1080		
1	508-1090		

Header Board with Hardware  
**No. 12000008H**

***Display Board No. 12003000***

The Weasler Display Center is a dealer merchandiser that makes selling easy.

*The display contains:*

- *48" × 66" floor fixture with silk screened part numbers*
- *point of sale sign*
- *inventory of the most popular sizes of sprockets, hubs, pulleys, idler sprockets*

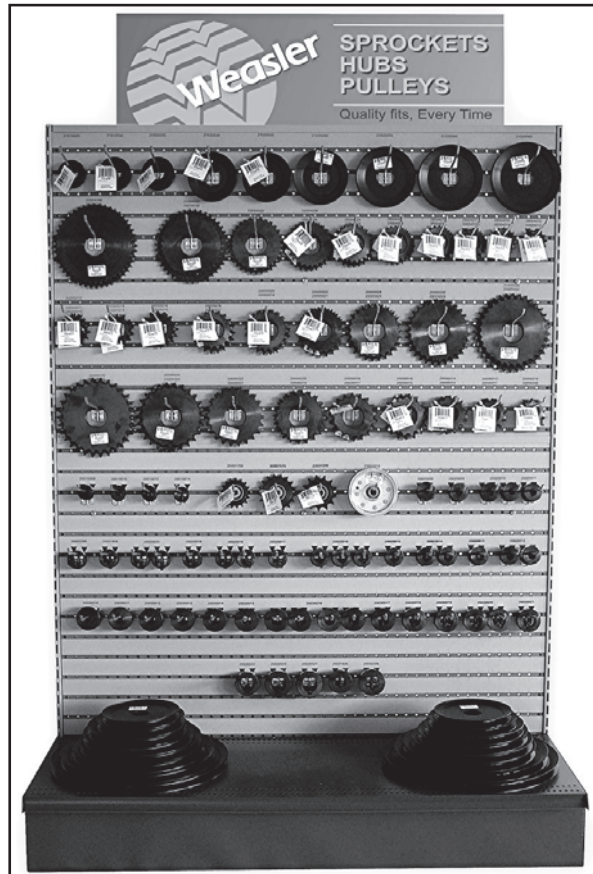

# DISPLAY COMPONENTS

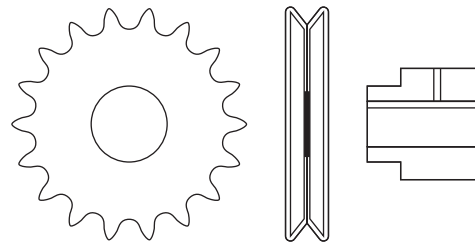

## #40 Sprocket

Stock Number	Quantity
20004012	3
20004013	3
20004014	3
20004015	3
20004016	3
20004017	3
20004018	3
20004019	3
20004020	3
20004021	2
20004022	2
20004024	2
20004026	2
20004028	2
20004030	2
20004032	2
20004036	2
20004040	1
20004045	1
20004048	1

## #50 Sprocket

Stock Number	Quantity
20005010	2
20005011	2
20005012	4
20005013	3
20005014	3
20005015	3
20005016	3
20005017	3
20005018	3
20005019	2
20005020	2
20005021	2
20005022	2
20005024	2
20005026	2
20005028	2
20005030	2
20005032	2
20005036	2

## #60 Sprocket

Stock Number	Quantity
20006009	2
20006010	2
20006011	3
20006012	3
20006013	3
20006014	3
20006015	3
20006016	2
20006017	2
20006018	2
20006019	2
20006020	2
20006021	2
20006022	2
20006024	2
20006026	2
20006028	1
20006030	1

## Idler Sprocket

Stock Number	Quantity
20401708	2
20501510	3
20601310	3

## Idler Pulley

Stock Number	Quantity
23004010	1

## Display Header

Stock Number	Quantity
12000003H	1

## Pulley

Stock Number	Quantity
21010025	3
21010030	3
21020035	3
21020040	3
21020045	3
21020050	3
21020055	3
21020060	3
21020065	2
21020070	2
21020080	2
21020090	2
21020100	2
21020110	2
21020120	2
21020140	2
21020160	2

## V Hub

Stock Number	Quantity
20010008	3
20010010	3
20010012	3
20010014	3

## W Hub

Stock Number	Quantity
20020008	2
20020009	1
20020010	4
20020011	1
20020012	4
20020013	1
20020014	4
20020015	2
20020016	10
20020017	1
20020018	4
20020019	1
20020020	4
20021806	1
20022206	1

## X Hub

Stock Number	Quantity
20030010	2
20030011	1
20030012	3
20030013	1
20030014	3
20030015	2
20030016	8
20030017	2
20030018	3
20030019	2
20030020	4
20030021	1
20030022	3
20030023	2
20030024	3
20031806	1
20032206	1

















**Weasler®**

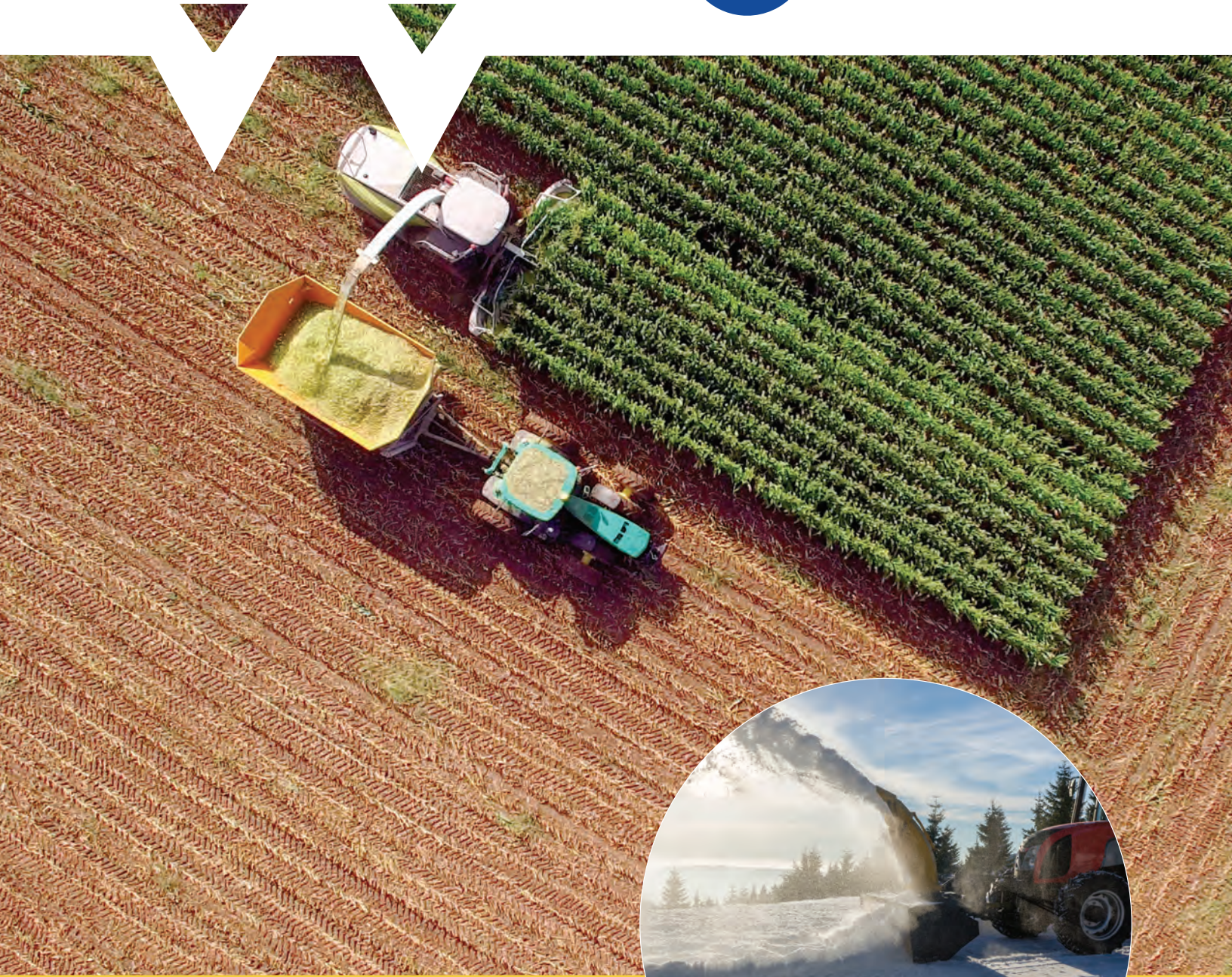

[www.weasler.com](http://www.weasler.com)

Weasler Engineering Inc.  
P.O. Box 558, West Bend, WI, 53095 USA  
Tel: (262) 338 2161 | Fax: (262) 338-7765