



**Stucchi<sup>®</sup>**



**UNLOCK THE SOLUTION<sup>™</sup>**





construction | agriculture | automation | chemical | plastics  
off-shore/land based oil & gas | pulp & paper | public utilities  
pharmaceutical | marine | food processing | military | mining | forestry  
mobile off highway | power generation | utilities | industrial | automotive





# Stucchi<sup>®</sup> UNLOCK THE SOLUTION™

Stucchi Inc. is an ISO 9001/Vision 2000 certified manufacturer of hydraulic quick disconnects. Our solutions-based approach meets the demanding requirements for a variety of applications spanning multiple markets including construction, agriculture, automation, chemical, off-shore and land-based oil & gas, pulp & paper, plastics, public utilities, and many others.

Stucchi is a recognized global leader in the design and manufacturing of quick coupling products providing a variety of sizes and port configurations ranging from 1/8 inch to 2 1/2 inch sizes to accommodate a wide field of application requirements. Our pressure capabilities extend to 10,000 psi working pressure, port configurations include imperial and metric standard in stock, materials from brass to 316 stainless steel, and an assortment of seal options.

**Technical Support** is provided by our experienced people in both customer service and field sales support representatives.

**Product Quality Assurance** is documented throughout our supply chain, beginning with raw material certifications, ongoing improvements in production material, automation of production, fatigue testing, pressure testing parts prior to shipping and an ISO quality management system.

**Prompt Shipment** of customer orders is essential. Our commitment to carry large inventory levels in North America allows Stucchi the capability to service our customers' needs promptly and efficiently.

**Custom Inventory capabilities** are available in the form of custom order codes, kits, or special packaging.

Many hydraulic quick couplers look alike on the outside, but performance, ease of use and overall reliability vary greatly between brands. We invite you to try our products and compare Stucchi to current suppliers and learn why Stucchi is the choice of leading OEMs and distributors globally. We thank you for considering Stucchi as your supplier of choice, and for our existing customers we appreciate your continued support.



# Product Index







Flat Face Style	
	<p><b>SERIES "A" PREMIER</b></p> <p>ISO 16028 Interchange Flat Face Coupling <b>Size:</b> 1/8, 1/4, 3/8, 1/2, 5/8, 3/4, 1, 1 1/4, 1 1/2 <b>Thread:</b> NPT, SAE, JIC, ORFS</p> <p>PAGE 6</p>
	<p><b>SERIES "A" PREMIER INTERNATIONAL</b></p> <p>ISO 16028 Interchange Flat Face Coupling <b>Size:</b> 1/8, 1/4, 3/8, 1/2, 5/8, 3/4, 1, 1 1/4, 1 1/2 <b>Thread:</b> BSP, DIN</p> <p>PAGE 11</p>
	<p><b>SERIES FIRG</b></p> <p>ISO 16028 Interchange Flat Face Coupling <b>Size:</b> 1/4, 3/8, 1/2, 5/8, 3/4, 1, 1 1/2, 2 <b>Thread:</b> NPT, SAE</p> <p>PAGE 16</p>
	<p><b>SERIES APM</b></p> <p>ISO 16028 Interchange Flat Face Nipple: Designed to Connect in the Presence of High Internal Residual Pressure <b>Size:</b> 3/8, 1/2, 5/8, 3/4, 1, 1 1/2 <b>Thread:</b> NPT, SAE, JIC, ORFS, BSP, DIN</p> <p>PAGE 20</p>
	<p><b>SERIES A-HD</b></p> <p>ISO 16028 Interchange Flat Face Coupler: Designed to Connect in the Presence of High Internal Residual Pressure <b>Size:</b> 1/2 <b>Thread:</b> NPT, SAE, JIC</p> <p>PAGE 24</p>
	<p><b>SERIES PUSH PULL</b></p> <p>ISO 16028 Interchange Flat Face Coupler: Designed with Push Pull Connection Sleeve and Clamp <b>Size:</b> 3/8, 1/2, 5/8, 3/4 <b>Thread:</b> NPT</p> <p>PAGE 26</p>
	<p><b>SERIES FL</b></p> <p>ISO 16028 Interchange Flat Face Coupling: 316 Stainless Steel for Corrosion <b>Size:</b> 1/4, 3/8, 1/2, 5/8, 3/4, 1, 1 1/2, 2 <b>Thread:</b> NPT, SAE, BSP</p> <p>PAGE 27</p>
	<p><b>SERIES FIRG Q</b></p> <p>ISO 16028 Interchange Flat Face Coupling: QPQ Treatment and Stainless Steel Internal Parts for Corrosion <b>Size:</b> 1/4, 3/8, 1/2, 5/8, 3/4, 1, 1 1/2, 2 <b>Thread:</b> NPT, SAE, BSP</p> <p>PAGE 31</p>
	<p><b>SERIES "A" PREMIER Z</b></p> <p>Flat Face Coupling: Special Zinc Treatment for Corrosion Applications <b>Size:</b> 3/8, 1/2, 5/8 <b>Thread:</b> NPT</p> <p>PAGE 35</p>
	<p><b>SERIES "A" HP</b></p> <p>Flat Face Coupling: 10,000 psi Working Pressure with Auto Lock Sleeve <b>Size:</b> 1/8, 1/4, 3/8 <b>Thread:</b> NPT, BSP</p> <p>PAGE 38</p>
	<p><b>SERIES VEP</b></p> <p>Flat Face Threaded Coupling: Connect/Disconnect Under High Residual Pressure <b>Size:</b> 1/4, 3/8, 1/2, 3/4, 1, 1 1/4, 1 1/2, 2 <b>Thread:</b> NPT, SAE, BSP, ORFS</p> <p>PAGE 41</p>
	<p><b>SERIES VEP HD</b></p> <p>Flat Face Threaded Coupling: Connect/Disconnect Under High Residual Pressure <b>Size:</b> 3/4, 1, 1 1/4, 1 1/2 <b>Thread:</b> NPT, SAE, Flange Ports</p> <p>PAGE 46</p>
	<p><b>SERIES VP</b></p> <p>Flat Face Threaded Coupling: Connect/Disconnect Under High Residual Pressure. Locking sleeve. <b>Size:</b> 1/4, 3/8, 1/2, 3/4, 1, 1 1/4, 1 1/2 <b>Thread:</b> NPT, SAE, BSP</p> <p>PAGE 52</p>



Poppet Style		Miscellaneous - cont.	
	<b>SERIES BIR</b> ISO A Interchange <b>Size:</b> 1/4, 3/8, 1/2, 3/4, 1, 1 1/4, 1 1/2, 2 <b>Thread:</b> NPT, BSP PAGE 56		<b>SERIES IRH</b> Interchange: Tema "T" Series <b>Size:</b> 1/4, 3/8, 1/2, 3/4, 1 <b>Thread:</b> NPT PAGE 82
	<b>SERIES I-IP</b> ISO A Interchange Push Pull Mount <b>Size:</b> 1/4, 3/8, 1/2, 3/4, 1 <b>Thread:</b> NPT, BSP PAGE 60		<b>SERIES VD</b> European Screw Coupler <b>Size:</b> 1/4, 3/8, 1/2, 3/4, 1, 1 1/4 PAGE 86
	<b>SERIES IRB   IRBO   IRBX</b> ISO B Interchange Material: Steel, Brass, 316 Stainless Steel <b>Size:</b> 1/4, 3/8, 1/2, 3/4, 1 <b>Thread:</b> NPT, BSP PAGE 64		<b>SERIES VR</b> German Screw Coupler <b>Size:</b> 3/8, 1/2, 1, 1 1/4 PAGE 91
	<b>SERIES IR   IRV   IRS</b> Ag Style Interchange Standard & Push Pull 2 Way Sleeve. PC Version for Connecting with High Internal Static Pressure <b>Size:</b> 1/4, 3/8, 1/2, 3/4, 1 <b>Thread:</b> NPT PAGE 69		<b>SERIES VLS</b> Heavy Duty Screw Coupler <b>Size:</b> 1/2, 1 PAGE 92
			<b>SERIES VU</b> Check Valves Cracking Point: 5 to 65 psi <b>Size:</b> 1/4, 3/8, 1/2, 3/4, 1, 1 1/4, 1 1/2, 2 <b>Thread:</b> NPT, SAE, BSP PAGE 93
Miscellaneous			
	<b>SERIES WING</b> Wing Style Interchange <b>Size:</b> 3/4, 1, 1 1/4, 1 1/2 <b>Thread:</b> NPT PAGE 76		
	<b>SERIES IVHP</b> Hydraulic Jack / Enerpac Interchange Thread to Connect 10,000 psi Working Pressure <b>Size:</b> 1/4, 3/8 <b>Thread:</b> NPT PAGE 77		
	<b>SERIES FIRG/ISO A ADAPTER</b> Adaptor Coupler <b>Size:</b> 1/2 PAGE 81		

# Product Index

## Multi-Coupling Plates, Dust Caps and Repair Kits

	<p><b>SERIES DP GR</b></p> <p>Single Handle Connection of Multiple Hydraulic Couplings Mounted in a Plate.  <b>Size:</b> 1/4 thru 1 1/4  <b>Option:</b> 2 to 10 Coupling Configurations</p> <p style="text-align: right;">PAGE 98</p>		<p><b>SERIES SPECIALTY COUPLERS</b></p> <p>Interchange: Stucchi Only  <b>Size:</b> 1/2, 3/4, 2, 2 1/2, 3  <b>Thread:</b> BSP, EXT, BSP-90</p> <p style="text-align: right;">PAGE 117</p>
	<p><b>SERIES GRE</b></p> <p>Single Handle Connection of Multiple Couplings for Oil, Water, Pneumatics in Industrial Applications for Quick Tool Changes.  <b>Size:</b> 3/8, 1/2  <b>Option:</b> 6, 12, 18 Couplings per Plate</p> <p style="text-align: right;">PAGE 107</p>		<p><b>SERIES DUST CAPS</b></p> <p><b>Material:</b> PVC/Rubber Blend for Flat Face, and Poppet Series  <b>Material:</b> Aluminum for IVHP, VP, VEP Series  <b>Material:</b> Brass for Wing Style</p> <p style="text-align: right;">PAGE 118</p>
	<p><b>SATURN BLOCK SERIES</b></p> <p><b>Size:</b> 1/2, 5/8, 3/4 Pressure Line  <b>Size:</b> 3/8 or 1/2 Return Line</p> <p style="text-align: right;">PAGE 112</p>		<p><b>SERIES REPAIR KITS</b></p> <p>Repair Kits for ISO A, Flat Face, VEP Series</p> <p style="text-align: right;">PAGE 121</p>

## Additional Information

INTERCHANGE GUIDE	PAGE 122
COUPLER/NIPPLE ID CHART	PAGE 126
STUCCHI USA MARKETING MATERIAL	PAGE 128





## Customer Service

**Satisfaction** Total customer satisfaction is our goal. Please call with any problems or feedback.

### **How to Open an Account/Same Day Approval Available**

- Contact the regional sales manager for approval, fill out the credit application by printing a copy from our website: [www.stucchiusa.com](http://www.stucchiusa.com)
- Fax completed and signed credit application for processing to 847-956-9723
- We will notify you by phone, fax, or e-mail of credit approval

**How to Order from Stucchi USA Inc.** We prefer orders to be faxed or e-mailed using the Stucchi order code to eliminate any possible errors. Our technical staff is available to take your order, assist you in finding the correct part, or answer any questions.

**Delivery/Shipment of Orders** Every order received is treated as a rush order. You tell us how fast you need it! Standard orders accepted until 4:30 pm for same day shipment. UPS Red orders are accepted until 5:00 pm Central time for same day shipment.

**Price Quote/Non-Catalog Items** Stucchi is constantly adding parts to its product offering. If a non-inventory or specialty part not listed in the catalog is needed, please fill out the technical data page in the back of the catalog and fax or mail the information along with a sample if possible. Call us for price and availability on your hard-to-find items. Formal quotations for products are furnished upon request.

## Company Policies

**Credit Policy** Our credit terms are net 30 days, less 1% 10 days. Accounts outstanding over 30 days are reviewed daily. All accounts that reach 30 days past due from invoice date will be changed to a COD account until past due amounts are paid. At 45 days past due all orders and backorders will automatically be put on credit hold until full payment is received. Payment for products should be made in U.S. dollars.

**Return Policy** Contact customer service to obtain a returned material authorization (RMA) number. Our receiving department cannot accept a return without a proper number. Parts must be returned within 30 days of receipt of goods. Returned goods are subject to a 20% restocking fee. All returns are subject to inspection and may be rejected if not in resaleable condition.

**Minimum Order and Invoice** All orders for less than \$100 are subject to a minimum net charge of \$100 plus shipping costs, unless waived by seller.

**Delivery** Regardless of the billing method or the party selecting the carrier, risk of loss shall pass to buyer upon seller's delivery to a carrier. Delivery dates are approximate only and the seller shall have no liability for delays in delivery.

**Limited Warranty** Stucchi manufactured products are warranted to the original user against defects in material and workmanship under normal use and proper installation (see Stucchi engineering CD for correct handling instructions) for one year after date of purchase, or 2000 operating hours, whichever comes first. The seller's sole obligation under this warranty is limited to repairing or replacing, as hereinafter provided, at its option any product found to seller's satisfaction to be defective upon examination by it within 30 days of discovery of defect. This warranty will not apply to any product that has been subject to abuse, accident, misapplication, or negligence. Warranty will not apply to altered products, repaired by someone other than seller and normal maintenance services and replacement of service items. Seller disclaims all warranties, expressed or implied, including but not limited to any implied warranties of merchantability or fitness for a particular purpose and any other obligation or liability. Stucchi strives to maintain the highest quality products to limit field service time due to failures in performance. However, if there is a need to return product, Stucchi's return policy requires a returned material authorization (RMA) number.

**Governing Laws** This agreement shall be construed to be between merchants. The laws of the State of Illinois shall govern any questions concerning its validity and/or construction of performance.

**Catalog Policy** The text, data and illustrations indicated in this catalog, may be changed by Stucchi at any time without notice.

# ISO 16028 Interchange Couplings Flat Face



## Flat Face

### Series: "A" Premier

**Interchange:** ISO 16028

Flat face "A" series couplings are in accordance with ISO 16028. The interchangeability of size 10 is also in accordance with NFPA T3.20.15 (HTMA).

- Seals: Nitrile and Teflon anti-extrusion
- Nipple: hardened steel reduces brinnelling
- 12 to 20 balls to increase the male bearing points & decrease the brinelling effect
- Modular structure for multiple port option
- Lock system stops unwanted disconnect
- Exceeds impulse test of ISOA-7241 test

### Overview

"A" series or Premier series offers higher pressure ratings, superior flow ratings, lower pressure drop compared to FIRG series or competitors products.

### Applications

Flat face couplers are specifically designed for applications needing no-leak performance. The mating faces are easily cleaned before connecting, making it the ideal solution for limiting contamination in a hydraulic circuit. The design allows applications involving high pressure impulses in agriculture equipment, mobile construction equipment and general industrial plants. Non-spill design avoids fluid loss in connection and disconnection.

### Options

- Seals: Viton, EPDM, and Kalrez
- Threads: NPT, SAE, ORFS, JIC
- Multiple mounting options







DESCRIPTION	SIZE	ISO SIZE	MAX. OPERATING PRESSURE COUPLED		BURST PRESSURE						SPILLAGE*
					COUPLED		MALE		FEMALE		
			MPa	psi	MPa	psi	MPa	psi	MPa	psi	
A4	1/8	-	42	6090	126	18270	126	18270	126	18270	0.001
A7	1/4	6.3	42	6090	126	18270	126	18270	126	18270	0.006
A9	3/8	10.0	35	5075	100	14500	100	14500	100	14500	0.012
A13	1/2	12.5	33	4785	100	14500	100	14500	100	14500	0.020
A15	5/8	16.0	33	4785	100	14500	100	14500	100	14500	0.026
A17	3/4	19.0	33	4785	100	14500	100	14500	100	14500	0.032
A21	1	25.0	30	4350	80	11600	80	11600	80	11600	0.035
A25	1 1/4	-	30	4350	80	11600	80	11600	80	11600	0.170
A30	1 1/2	-	27	3915	80	11600	80	11600	70	10150	0.050

\* SPILLAGE IS AN INDICATIVE VALUE OF THE FLUID LOSS PER COUPLE-UNCUPLE CYCLE.

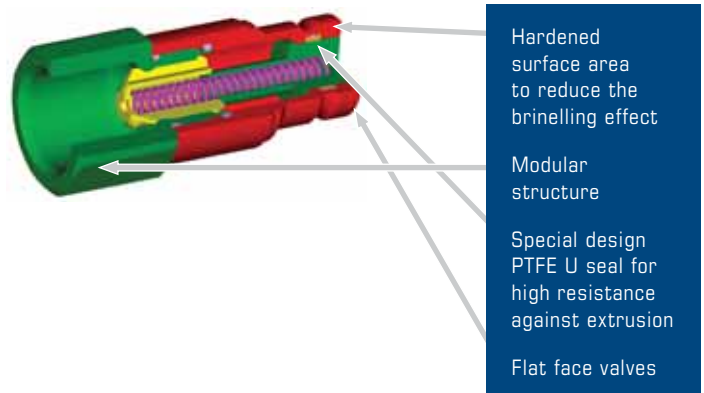
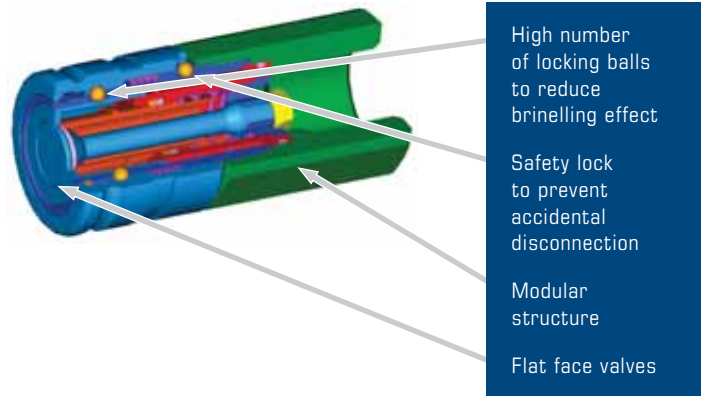
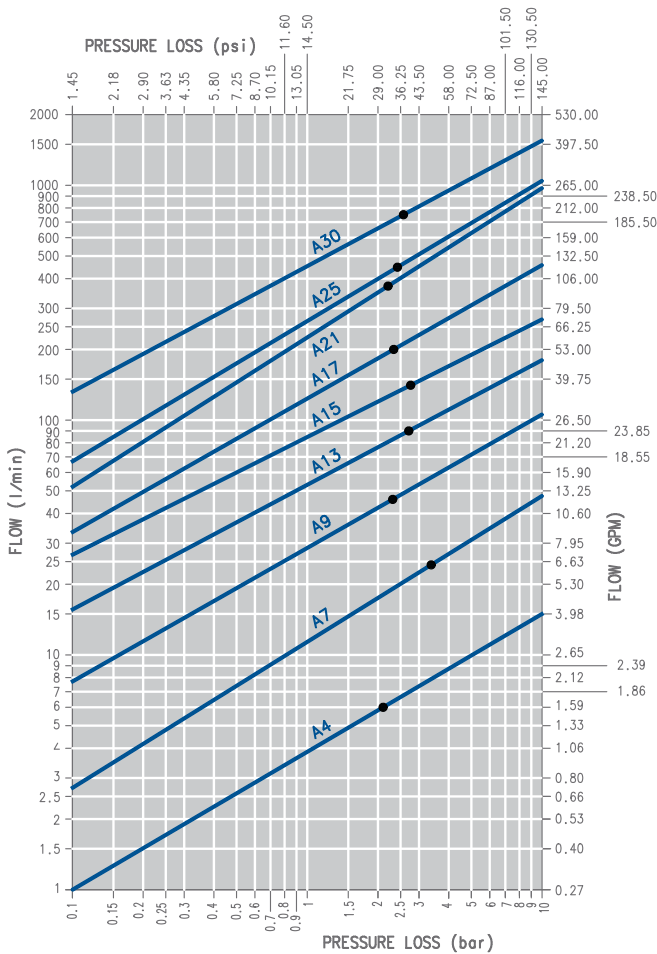

## Flat Face: "A" Series Size Diagram

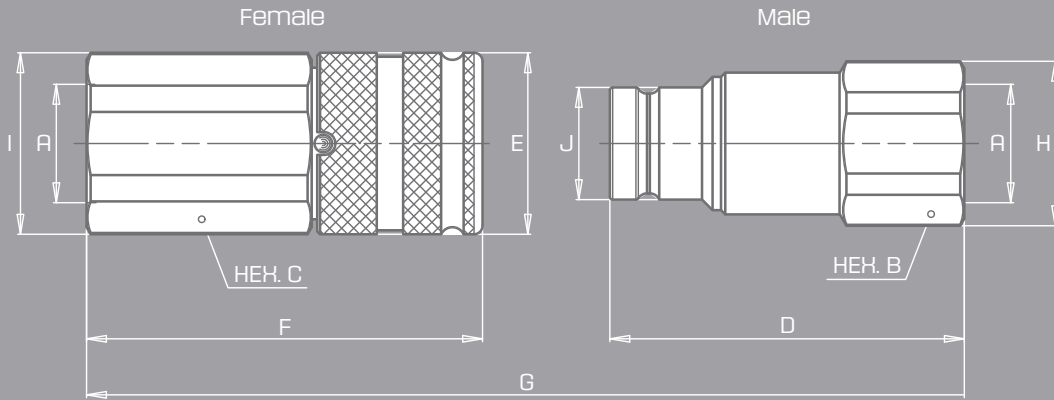

DESCRIPTION	BODY SIZE	A	UNIT	B	C	D	E	F	G	H	I	J	UNIT	WEIGHT	
														MALE	FEMALE
A4	1/8	1/8	mm	17.0	19.0	36.3	20.0	40.0	68.4	18.5	20.5	11.6	Kg	0.038	0.073
			inch	0.67	0.75	1.43	0.79	1.57	2.69	0.73	0.81	0.46	lb	0.08	0.16
A7	1/4	1/4	mm	22.0	27.0	47.9	28.0	53.1	90.2	23.8	29.0	16.1	Kg	0.088	0.187
			inch	0.87	1.06	1.89	1.10	2.09	3.55	0.94	1.14	0.63	lb	0.19	0.41
A9	3/8	3/8	mm	27.0	30.0	60.0	32.0	64.8	108.8	29.0	32.0	19.7	Kg	0.150	0.273
			inch	1.06	1.18	2.36	1.26	2.55	4.28	1.14	1.26	0.78	lb	0.33	0.60
A9	3/8	1/2	mm	27.0	30.0	62.5	32.0	69.8	116.3	29.0	32.0	19.7	Kg	0.138	0.278
			inch	1.06	1.18	2.46	1.26	2.75	4.58	1.14	1.26	0.78	lb	0.30	0.61
A13	1/2	1/2	mm	36.0	36.0	68.0	38.0	76.8	127.5	40.0	40.0	24.5	Kg	0.295	0.452
			inch	1.42	1.42	2.68	1.50	3.02	5.02	1.57	1.57	0.96	lb	0.65	1.00
A13	1/2	3/4	mm	36.0	36.0	70.5	38.0	83.8	137.0	40.0	40.0	24.5	Kg	0.273	0.469
			inch	1.42	1.42	2.78	1.50	3.30	5.39	1.57	1.57	0.96	lb	0.60	1.03
A15	5/8	3/4	mm	36.0	41.0	73.0	42.0	84.0	139.4	38.5	44.8	27.0	Kg	0.292	0.631
			inch	1.42	1.61	2.87	1.65	3.31	5.49	1.52	1.76	1.06	lb	0.64	1.39
A17	3/4	3/4	mm	46.0	46.0	83.7	48.0	95.8	157.5	49.8	49.8	30.0	Kg	0.535	0.960
			inch	1.81	1.81	3.30	1.89	3.77	6.20	1.96	1.96	1.18	lb	1.18	2.12
A17	3/4	1	mm	46.0	46.0	83.7	48.0	98.8	160.5	49.8	49.8	30.0	Kg	0.473	0.931
			inch	1.81	1.81	3.30	1.89	3.89	6.32	1.96	1.96	1.18	lb	1.04	2.05
A21	1	1	mm	55.0	55.0	96.8	55.0	104.8	178.6	59.8	59.8	36.0	Kg	0.900	1.430
			inch	2.17	2.17	3.81	2.17	4.13	7.03	2.35	2.35	1.42	lb	1.98	3.15
A21	1	1 1/4	mm	55.0	55.0	90.0	55.0	105.8	172.8	59.8	59.8	36.0	Kg	0.700	1.312
			inch	2.17	2.17	3.54	2.17	4.17	6.80	2.35	2.35	1.42	lb	1.54	2.89
A25	1 1/4	1	mm	55.0	55.0	105.0	65.0	125.1	206.8	59.8	65.0	44.0	Kg	1.105	2.100
			inch	2.17	2.17	4.13	2.56	4.93	8.14	2.35	2.56	1.73	lb	2.44	4.63
A25	1 1/4	1 1/4	mm	55.0	55.0	105.0	65.0	125.1	206.8	59.8	65.0	44.0	Kg	1.105	2.100
			inch	2.17	2.17	4.13	2.56	4.93	8.14	2.35	2.56	1.73	lb	2.44	4.63
A30	1 1/2	1 1/2	mm	65.0	65.0	111.1	80.0	132.4	214.9	69.8	82.0	57.0	Kg	1.665	3.140
			inch	2.56	2.56	4.37	3.15	5.21	8.46	2.75	3.23	2.24	lb	3.67	6.92



**Interchange\_NPT Thread | ISO 16028**

PART	BODY SIZE	PORT SIZE	THREAD TYPE	ORDER CODE	PART DESCRIPTION
<b>A PREMIER NPT THREAD</b>					
COUPLER	1/8	1/8	NPT	801301002	F. A4 1/8 NPT
NIPPLE	1/8	1/8	NPT	801301003	M. A4 1/8 NPT
COUPLER	1/4	1/4	NPT	801301004	F. A7 1/4 NPT
NIPPLE	1/4	1/4	NPT	800801001	M. FIRG 14 NPT
COUPLER	3/8	3/8	NPT	801301006	F. A9 3/8 NPT
NIPPLE	3/8	3/8	NPT	801301005	M. A9 3/8 NPT
COUPLER	3/8	1/2	NPT	801301008	F. A9 1/2 NPT
NIPPLE	3/8	1/2	NPT	801301007	M. A9 1/2 NPT
COUPLER	1/2	1/2	NPT	801301010	F. A13 1/2 NPT
NIPPLE	1/2	1/2	NPT	801301009	M. A13 1/2 NPT
COUPLER	1/2	3/4	NPT	801301012	F. A13 3/4 NPT
NIPPLE	1/2	3/4	NPT	801301011	M. A13 3/4 NPT
COUPLER	5/8	3/4	NPT	801301014	F. A15 3/4 NPT
NIPPLE	5/8	3/4	NPT	801301013	M. A15 3/4 NPT
COUPLER	5/8	1	NPT	801301020	F. A15 1 NPT
NIPPLE	5/8	1	NPT	801301019	M. A15 1 NPT
COUPLER	3/4	3/4	NPT	801301030	F. A17 3/4 NPT
NIPPLE	3/4	3/4	NPT	801301031	M. A17 3/4 NPT
COUPLER	3/4	1	NPT	801301000	F. A17 1 NPT
NIPPLE	3/4	1	NPT	801301001	M. A17 1 NPT
COUPLER	1	1	NPT	801301028	F. A21 1 NPT
NIPPLE	1	1	NPT	801301029	M. A21 1 NPT
COUPLER	1	1 1/4	NPT	801301016	F. A21 114 NPT
NIPPLE	1	1 1/4	NPT	801301015	M. A21 114 NPT
COUPLER	1 1/4	1 1/4	NPT	801301034	F. A25 114 NPT
NIPPLE	1 1/4	1 1/4	NPT	801301035	M. A25 114 NPT
COUPLER	1 1/2	1 1/2	NPT	801301018	F. A30 112 NPT
NIPPLE	1 1/2	1 1/2	NPT	801301017	M. A30 112 NPT



COUPLER



NIPPLE

**Skid Steer Applications\_Custom Ports | Male Threads | ISO 16028**

PART	BODY SIZE	PORT SIZE	THREAD TYPE	ORDER CODE	PART DESCRIPTION
<b>A PREMIER JIC AND ORFS THREAD</b>					
COUPLER	3/8	1/2	JIC BULKHEAD	801306014	F. A9 1/2 JIC BH
NIPPLE	3/8	1/2	JIC BULKHEAD	801306015	M. A9 1/2 JIC BH
COUPLER	1/2	1/2	JIC BULKHEAD	803306006	F. A13D 1/2 JIC BH
NIPPLE	1/2	1/2	JIC BULKHEAD	801306031	M. A13D 1/2 JIC BH
COUPLER	1/2	5/8	JIC BULKHEAD	803306000	F. A13D 5/8 JIC BH
NIPPLE	1/2	5/8	JIC BULKHEAD	801306017	M. A13 5/8 JIC BH
COUPLER	1/2	3/4	JIC BULKHEAD	801306024	F. A13 3/4 JIC BH
NIPPLE	1/2	3/4	JIC BULKHEAD	801306025	M. A13 3/4 JIC BH
COUPLER	3/4	3/4	JIC BULKHEAD	801306028	F. A17 3/4 JIC BH
NIPPLE	3/4	3/4	JIC BULKHEAD	801306029	M. A17 3/4 JIC BH
COUPLER	1/2	5/8	JIC INTERNAL	803706002	F. A13 TI 5/8 JIC INT
NIPPLE	1/2	5/8	JIC INTERNAL	803706003	M. A13 TI 5/8 JIC INT
COUPLER	1/2	5/8	ORFS BULKHEAD	803313000	F. A13D 5/8 ORFSBH
NIPPLE	1/2	5/8	ORFS BULKHEAD	801313001	M. A13 5/8 ORFSBH
COUPLER	1/2	3/4	ORFS BULKHEAD	803313002	F. A13D 3/4 ORFSBH
NIPPLE	1/2	3/4	ORFS BULKHEAD	801313005	M. A13 3/4 ORFSBH
COUPLER	1/2	1	ORFS BULKHEAD	803313004	F. A13D 1 ORFSBH
NIPPLE	1/2	1	ORFS BULKHEAD	801313007	M. A13 1 ORFSBH



# ISO 16028 Interchange Couplings Flat Face



COUPLER



NIPPLE

## Interchange\_SAE Thread | ISO 16028

PART	BODY SIZE	PORT SIZE	THREAD TYPE	ORDER CODE	PART DESCRIPTION
<b>A PREMIER SAE THREAD</b>					
COUPLER	1/8	1/8	SAE	801304002	F. A4 3/16 SAE
NIPPLE	1/8	1/8	SAE	801304003	M. A4 3/16 SAE
COUPLER	1/4	3/8	SAE	801304004	F. A7 3/8 SAE
NIPPLE	1/4	3/8	SAE	800804001	M. FIRG 14 3/8 SAE
COUPLER	3/8	3/8	SAE	801304006	F. A9 3/8 SAE
NIPPLE	3/8	3/8	SAE	801304005	M. A9 3/8 SAE
COUPLER	3/8	1/2	SAE	801304008	F. A9 1/2 SAE
NIPPLE	3/8	1/2	SAE	801304007	M. A9 1/2 SAE
COUPLER	3/8	5/8	SAE	801304030	F. A9 5/8 SAE
NIPPLE	3/8	5/8	SAE	801304031	M. A9 5/8 SAE
COUPLER	1/2	1/2	SAE	803304004	F. A13 1/2 SAE
NIPPLE	1/2	1/2	SAE	801304035	M. A13 1/2 SAE
COUPLER	1/2	5/8	SAE	801304024	F. A13 5/8 SAE
NIPPLE	1/2	5/8	SAE	801304025	M. A13 5/8 SAE
COUPLER	1/2	3/4	SAE	801304010	F. A13 3/4 SAE
NIPPLE	1/2	3/4	SAE	801304009	M. A13 3/4 SAE
COUPLER	5/8	3/4	SAE	801304012	F. A15 3/4 SAE
NIPPLE	5/8	3/4	SAE	801304011	M. A15 3/4 SAE
COUPLER	3/4	3/4	SAE	801304028	F. A17 3/4 SAE
NIPPLE	3/4	3/4	SAE	801304029	M. A17 3/4 SAE
COUPLER	3/4	1	SAE	801304000	F. A17 1 SAE
NIPPLE	3/4	1	SAE	801304001	M. A17 1 SAE
COUPLER	1	1	SAE	801304038	F. A21 1 SAE
NIPPLE	1	1	SAE	801304039	M. A21 1 SAE
COUPLER	1	1 1/4	SAE	801304014	F. A21 114 SAE
NIPPLE	1	1 1/4	SAE	801304013	M. A21 114 SAE
COUPLER	1 1/4	1 1/4	SAE	801304042	F. A25 114 SAE
NIPPLE	1 1/4	1 1/4	SAE	801304043	M. A25 114 SAE
COUPLER	1 1/2	1 1/2	SAE	801304016	F. A30 112 SAE
NIPPLE	1 1/2	1 1/2	SAE	801304015	M. A30 112 SAE



## Hand Tool Applications\_Special Configuration | ISO 16028

PART	BODY SIZE	PORT SIZE	THREAD TYPE	ORDER CODE	PART DESCRIPTION
<b>A PREMIER MALE SAE THREAD</b>					
COUPLER	3/8	3/8	MALE SAE	803704004	F. A9 3/8 T30 SAE EXT
NIPPLE	3/8	3/8	MALE SAE	801304037	M. A9 3/8 SAE EXT
COUPLER	3/8	1/2	MALE SAE	803704006	F. A9 1/2 T30 SAE EXT
COUPLER	3/8	1/2	MALE SAE	801304032	F. A9 1/2 SAE EXT
NIPPLE	3/8	1/2	MALE SAE	801304033	M. A9 1/2 SAE EXT
<b>A PREMIER FEMALE NPT THREAD</b>					
COUPLER	3/8	3/8	FEMALE NPT	803601000	F. FIRG 3/8 T30 NPT
COUPLER	3/8	1/2	FEMALE NPT	803601002	F. FIRG 1/2 T30 NPT







## Flat Face: International Ports

Series: "A" Premier

**Interchange:** ISO 16028

"A" series couplings are in compliance for interchangeability and performance of ISO 16028

**International Ports:** British or German DIN

All features and benefits of "A" Premier series with convenient international port configurations

- Seals: Nitrile & Teflon anti-extrusion
- Eliminate hard to find adapters and leak points
- Nipple: hardened steel reduces brinnelling
- 12 to 20 balls to increase the male bearing points and decrease the brinnelling effect
- Lock system stops unwanted disconnect
- Exceeds impulse test of ISOA-7241 test



# ISO 16028 Interchange Couplings

## Flat Face: International Ports

### BSP International Port\_ISO 16028

PART	BODY SIZE	THREAD TYPE	THREAD SIZE	PORT THREAD	ORDER CODE	PART DESCRIPTION
<b>A PREMIER BSP THREAD</b>						
COUPLER	1/8	BSP	1/8	1/8 - 19	801300002	F. A4 1/8 BSP
NIPPLE	1/8	BSP	1/8	1/8 - 19	801300003	M. A4 1/8 BSP
COUPLER	1/4	BSP	1/4	1/4 - 19	801300004	F. A7 1/4 BSP
NIPPLE	1/4	BSP	1/4	1/4 - 19	801300031	M. A7 1/4 BSP
NIPPLE	3/8	BSP	3/8	3/8 - 19	801300005	M. A9 3/8 BSP
COUPLER	3/8	BSP	3/8	3/8 - 19	801300006	F. A9 3/8 BSP
NIPPLE	3/8	BSP	1/2	1/2 - 14	801300007	M. A9 1/2 BSP
COUPLER	3/8	BSP	1/2	1/2 - 14	801300008	F. A9 1/2 BSP
NIPPLE	1/2	BSP	1/2	1/2 - 14	801300013	M. A13 1/2 BSP
COUPLER	1/2	BSP	1/2	1/2 - 14	801300014	F. A13 1/2 BSP
NIPPLE	1/2	BSP	3/4	3/4 - 14	801300015	M. A13 3/4 BSP
COUPLER	1/2	BSP	3/4	3/4 - 14	801300016	F. A13 3/4 BSP
NIPPLE	5/8	BSP	3/4	3/4 - 14	801300021	M. A15 3/4 BSP
COUPLER	5/8	BSP	3/4	3/4 - 14	801300022	F. A15 3/4 BSP
COUPLER	3/4	BSP	3/4	3/4 - 14	801300040	F. A17 3/4 BSP
NIPPLE	3/4	BSP	3/4	3/4 - 14	801300041	M. A17 3/4 BSP
COUPLER	3/4	BSP	1	1 - 11	801300000	F. A17 1 BSP
NIPPLE	3/4	BSP	1	1 - 11	801300001	M. A17 1 BSP
NIPPLE	1	BSP	1 1/4	1 1/4 - 11	801300023	M. A21 1 1/4 BSP
COUPLER	1	BSP	1 1/4	1 1/4 - 11	801300024	F. A21 1 1/4 BSP
COUPLER	1 1/4	BSP	1 1/4	1 1/4 - 11	801300052	F. A25 114 BSP
NIPPLE	1 1/4	BSP	1 1/4	1 1/4 - 11	801300053	M. A25 114 BSP
COUPLER	1 1/2	BSP	1 1/2	1 1/2 - 11	801300026	F. A30 1 1/2 BSP
NIPPLE	1 1/2	BSP	1 1/2	1 1/2 - 11	801300025	M. A30 1 1/2 BSP



**DIN International Port**\_L (Light) and S (Heavy) | ISO 16028 | DIN 3852

PARTS	BODY SIZE	METRIC THREAD	PART SERIES	TUBE O.D.	THREAD SIZE	ORDER CODE	PART DESCRIPTION
<b>A PREMIER DIN THREAD</b>							
COUPLER	1/4	DIN	L	10	M 16X1.5	801308010	F. A7 L10
NIPPLE	1/4	DIN	L	10	M 16X1.5	801308011	M. A7 L10
COUPLER	3/8	DIN	L	10	M 16X1.5	801308008	F. A9 L10
NIPPLE	3/8	DIN	L	10	M 16X1.5	801308009	M. A9 L10
COUPLER	3/8	DIN	L	12	M 18X1.5	801308004	F. A9 L12
NIPPLE	3/8	DIN	L	12	M 18X1.5	801308005	M. A9 L12
COUPLER	3/8	DIN	L	15	M 22X1.5	801308006	F. A9 L15
NIPPLE	3/8	DIN	L	15	M 22X1.5	801308007	M. A9 L15
COUPLER	1/2	DIN	L	12	M 18X1.5	801308000	F. A13 L12
NIPPLE	1/2	DIN	L	12	M 18X1.5	801308001	M. A13 L12
COUPLER	1/2	DIN	L	15	M 22X1.5	801308002	F. A13 L15
NIPPLE	1/2	DIN	L	15	M 22X1.5	801308003	M. A13 L15
COUPLER	5/8	DIN	L	15	M 22X1.5	801308016	F. A15 L15
NIPPLE	5/8	DIN	L	15	M 22X1.5	801308017	M. A15 L15
COUPLER	5/8	DIN	L	22	M 30X2	801308020	F. A15 L22
NIPPLE	5/8	DIN	L	22	M 30X2	801308021	M. A15 L22
COUPLER	3/4	DIN	L	22	M 30X2	801308024	F. A17 L22
NIPPLE	3/4	DIN	L	22	M 30X2	801308025	M. A17 L22
COUPLER	1/4	DIN	S	10	M 18X1.5	801309004	F. A7 S10
NIPPLE	1/4	DIN	S	10	M 18X1.5	801309005	M. A7 S10
COUPLER	3/8	DIN	S	10	M 18X1.5	801309006	F. A9 S10
NIPPLE	3/8	DIN	S	10	M 18X1.5	801309007	M. A9 S10
COUPLER	3/8	DIN	S	12	M 20X1.5	801309008	F. A9 S12
NIPPLE	3/8	DIN	S	12	M 20X1.5	801309009	M. A9 S12
COUPLER	1/2	DIN	S	12	M 20X1.5	801309014	F. A13 S12
NIPPLE	1/2	DIN	S	12	M 20X1.5	801309015	M. A13 S12
COUPLER	3/8	DIN	FEMALE	22	M 22X1.5	801312000	F. A9 M22X1.5
NIPPLE	3/8	DIN	FEMALE	22	M 22X1.5	801312001	M. A9 M22X1.5



COUPLER  
L (LIGHT) OR S (HEAVY)



NIPPLE  
PORT SERIES:  
L (LIGHT) OR S (HEAVY)

# ISO 16028 Interchange Couplings

## Flat Face: International Ports

DIN International Port\_L (Light) and S (Heavy) | SCHOTT (DIN Blukhead) | ISO 16028 | DIN 3852

PART	BODY SIZE	METRIC THREAD	PORT SERIES	TUBE O.D.	THREAD SIZE	ORDER CODE	PART DESCRIPTION
<b>A PREMIER DIN THREAD</b>							
COUPLER	1/4	DIN	L	10	M 16X1.5 SCHOTT	801310010	F. A7 L10 SCHOTT
NIPPLE	1/4	DIN	L	10	M 16X1.5 SCHOTT	801310011	M. A7 L10 SCHOTT
COUPLER	3/8	DIN	L	12	M 18X1.5 SCHOTT	801310004	F. A9 L12 SCHOTT
NIPPLE	3/8	DIN	L	12	M 18X1.5 SCHOTT	801310005	M.A9 L12 SCHOTT
COUPLER	3/8	DIN	L	15	M 16X1.5 SCHOTT	801310006	F. A9 L15 SCHOTT
NIPPLE	3/8	DIN	L	15	M 16X1.5 SCHOTT	801310007	M. A9 L15 SCHOTT
COUPLER	3/8	DIN	L	10	M 16X1.5 SCHOTT	801310008	F. A9 L10 SCHOTT
NIPPLE	3/8	DIN	L	10	M 16X1.5 SCHOTT	801310009	M. A9 L10 SCHOTT
COUPLER	1/2	DIN	L	12	M 18X1.5 SCHOTT	801310000	F. A13 L12 SCHOTT
NIPPLE	1/2	DIN	L	12	M 18X1.5 SCHOTT	801310001	M. A13 L12 SCHOTT
COUPLER	1/2	DIN	L	15	M 22X1.5 SCHOTT	801310002	F. A13 L15 SCHOTT
NIPPLE	1/2	DIN	L	15	M 22X1.5 SCHOTT	801310003	M. A13 L15 SCHOTT
COUPLER	5/8	DIN	L	18	M 26X1.5 SCHOTT	801310018	F. A15 L18 SCHOTT
NIPPLE	5/8	DIN	L	18	M 26X1.5 SCHOTT	801310019	M. A15 L18 SCHOTT
COUPLER	5/8	DIN	L	22	M 30X1.5 SCHOTT	801310020	F. A15 L22 SCHOTT
NIPPLE	5/8	DIN	L	22	M 30X1.5 SCHOTT	801310021	M. A15 L22 SCHOTT
COUPLER	3/4	DIN	L	18	M 26X1.5 SCHOTT	801310022	F. A17 L18 SCHOTT
NIPPLE	3/4	DIN	L	18	M 26X1.5 SCHOTT	801310023	M. A17 L18 SCHOTT
COUPLER	3/4	DIN	L	22	M 30X1.5 SCHOTT	801310024	F. A17 L22 SCHOTT
NIPPLE	3/4	DIN	L	22	M 30X1.5 SCHOTT	801310025	M. A17 L22 SCHOTT
COUPLER	3/8	DIN	S	12	M 20X1.5 SCHOTT	801311008	F. A9 S12 SCHOTT
NIPPLE	3/8	DIN	S	12	M 20X1.5 SCHOTT	801311009	M. A9 S12 SCHOTT
COUPLER	1/2	DIN	S	12	M 20X1.5 SCHOTT	801311014	F. A13 S12 SCHOTT
NIPPLE	1/2	DIN	S	12	M 20X1.5 SCHOTT	801311015	M. A13 S12 SCHOTT
COUPLER	1/2	DIN	S	16	M 24X1.5 SCHOTT	801311018	F. A13 S16 SCHOTT
NIPPLE	1/2	DIN	S	16	M 24X1.5 SCHOTT	801311019	M. A13 S16 SCHOTT
COUPLER	5/8	DIN	S	16	M 24X1.5 SCHOTT	801311022	F. A15 S16 SCHOTT
NIPPLE	5/8	DIN	S	16	M 24X1.5 SCHOTT	801311023	M. A15 S16 SCHOTT
COUPLER	5/8	DIN	S	20	M 30X1.5 SCHOTT	801311024	F. A15 S20 SCHOTT
NIPPLE	5/8	DIN	S	20	M 30X1.5 SCHOTT	801311025	M. A15 S20 SCHOTT



COUPLER  
L (LIGHT) OR S (HEAVY)  
SCHOTT



NIPPLE  
L (LIGHT) OR S (HEAVY)  
SCHOTT





**DIN International Port**\_L (Light) and S (Heavy) | SCHOTT (DIN Blukhead) | No Safety Lock Mechanism | ISO 16028 | DIN 3852

PART	BODY SIZE	METRIC THREAD	PORT SERIES	TUBE O.D.	THREAD SIZE	ORDER CODE	PART DESCRIPTION
<b>A PREMIER DIN THREAD</b>							
COUPLER	1/4	DIN	L	10	M 16X1.5 SCHOTT	803010008	F. A7 SS L10 SCHOTT
COUPLER	3/8	DIN	L	10	M 16X1.5 SCHOTT	803010010	F. A9 SS L10 SCHOTT
COUPLER	3/8	DIN	L	12	M 18X1.5 SCHOTT	803010004	F. A9 SS L12 SCHOTT
COUPLER	3/8	DIN	L	15	M 22X1.5 SCHOTT	803010006	F. A9 SS L15 SCHOTT
COUPLER	1/2	DIN	L	12	M 18X1.5 SCHOTT	803010000	F. A13 SS L12 SCHOTT
COUPLER	1/2	DIN	L	15	M 22X1.5 SCHOTT	803010002	F. A13 SS L15 SCHOTT
COUPLER	1/2	DIN	L	22	M 22X2 SCHOTT	803010012	F. A13 SS L22 SCHOTT
COUPLER	3/8	DIN	L	15	M 22X1.5	803108000	F. A9 K SS L15
COUPLER	3/8	DIN	L	12	M 18X1.5	803108002	F. A9 K SS L12
COUPLER	3/8	DIN	L	12	M 18X1.5	803008004	F.A9 SS L12
COUPLER	3/8	DIN	L	15	M 22X1.5	803008006	F. A9 SS L15
COUPLER	3/8	DIN	L	10	M 16X1.5	803008010	F. A9 SS L10
COUPLER	1/2	DIN	L	22	M 22X2	803008018	F. A13 SS L22
COUPLER	5/8	DIN	L	22	M 22X2	803008016	F. A15 SS L22
COUPLER	3/8	DIN	S	12	M 20X1.5	803009000	F. A9 SS S12
COUPLER	1/2	DIN	S	12	M 20X1.5	803009002	F. A13 SS S12
COUPLER	1/2	DIN	S	16	M 24X1.5 SCHOTT	803011000	F. A13 SS S16 SCHOTT
COUPLER	1/2	DIN	S	20	M 30X2 SCHOTT	803011002	F. A13 SS S20 SCHOTT

**To identify the DIN fitting size, measure the following:**

Using a thread gauge, determine the number of millimeters per thread. With calipers, find the thread diameter by measuring the O.D. on the male and I.D. on the female. Measure the tube O.D. with the calipers so you can identify the fitting as either light series or heavy series.

# ISO 16028 Interchange Couplings Flat Face



## Flat Face

### Series: FIRG

**Interchange:** ISO 16028

The FIRG quick coupling, head of the family of flat face has been produced since 1983. Interchangeability in accordance with ISO 16028. The interchangeability of size 3/8 is also in accordance with NFPA T3.20.15 (HTMA).

- Nitrile seal with specially shaped anti extrusion rings in Teflon
- FIRG designed integrated sealing mechanism greatly reduces premature wear by movement between coupler and nipple parts caused by impulse pressure and by the weight of the flexible pipes when the coupling is in horizontal position

### Overview

The "Original One", that is the FIRG flat face series from Stucchi. Developed in 1983, Stucchi has supplied the original ISO 16028 interchangeable coupling, and still continues to supply this series due to the good performance, long life and competitive prices on this series.

### Applications

Mobile Construction, Agriculture, General Industrial, Mining or anywhere fluid loss and contamination of a hydraulic circuit needs to be eliminated.

### Options

- Couplings: zinc plated steel
- Nipple: hardened steel for anti-brinelling
- Seals: Nitrile with Teflon anti-extrusion ring
- Viton, Kalrez, EPDM upon request
- Ports: NPT, SAE
- Tight tolerances ensure equal loading of couplers
- Female seal swaged to prevent extrusion
- No air inclusion during connection
- Flat mating surface easily cleaned
- Non-spill design avoids fluid loss during connection/disconnection



DESCRIPTION	SIZE	ISO SIZE	MAX. OPERATING PRESSURE COUPLED		BURST PRESSURE						SPILLAGE*
					COUPLED		MALE		FEMALE		
			MPa	psi	MPa	psi	MPa	psi	MPa	psi	
FIRG14	1/4	6.3	30	4350	120	17400	126	18270	48	6960	0.006
FIRG38-12	3/8	10.0	30	4350	120	17400	120	17400	48	6960	0.012
FIRG12A-34	1/2	12.5	25	3625	100	14500	100	14500	40	5800	0.020
FIRG34B	5/8	16.0	25	3625	100	14500	88	12760	40	5800	0.026
FIRG34A	3/4	19.0	33	4785	100	14500	100	14500	100	14500	0.032
FIRG100	3/4	19.0	25	3625	100	14500	80	11600	40	5800	0.032
FIRG114	1	25.0	25	3625	100	14500	80	11600	40	5800	0.035
FIRG112	1 1/2	-	20	2900	80	11600	80	11600	32	4640	0.050
FIRG200	2	-	20	2900	80	11600	64	9280	32	4640	0.100

\* SPILLAGE IS AN INDICATIVE VALUE OF THE FLUID LOSS PER COUPLE-UNCUPLE CYCLE.

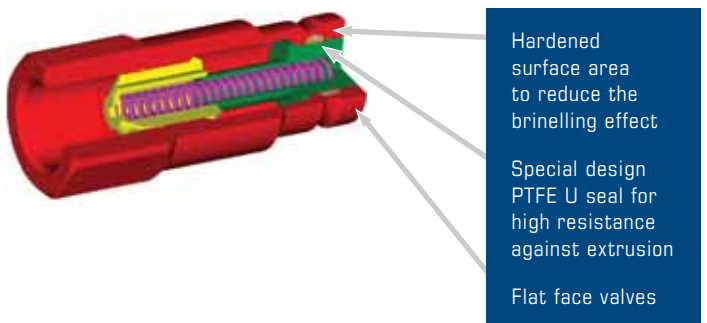
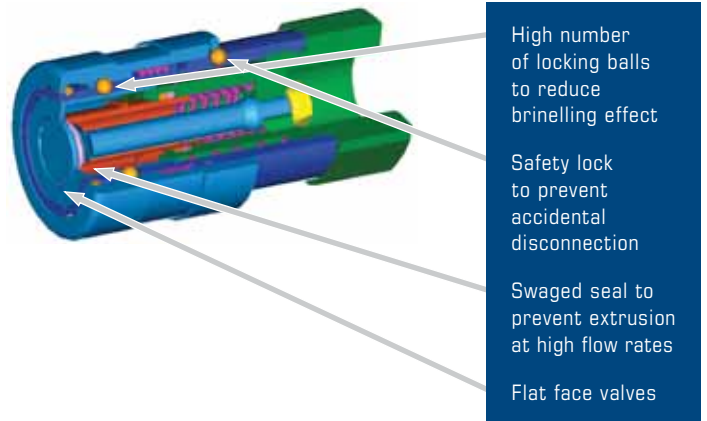
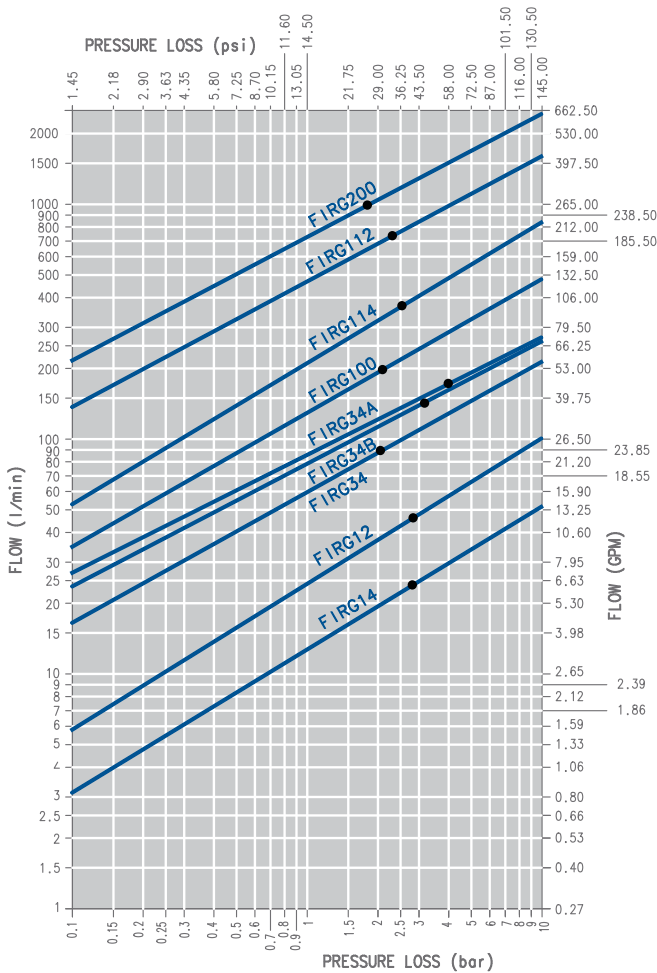

## Flat Face: FIRG Series Size Diagram

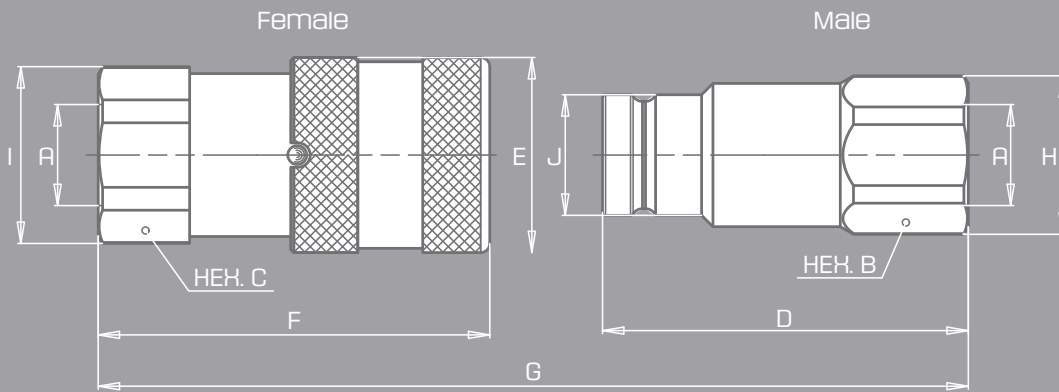

DESCRIPTION	BODY SIZE	A	UNIT	B	C	D	E	F	G	H	I	J	UNIT	WEIGHT	
														MALE	FEMALE
FIRG14	1/4	1/4	mm	22.0	22.0	47.9	28.0	48.1	85.2	23.8	23.8	16.1	Kg	0.086	0.140
			inch	0.87	0.87	1.89	1.10	1.89	3.35	0.94	0.94	0.63	lb	0.19	0.31
FIRG38	3/8	3/8	mm	24.0	27.0	60.0	32.0	64.2	108.7	26.0	29.0	19.7	Kg	0.121	0.235
			inch	0.94	1.06	2.36	1.26	2.53	4.28	1.02	1.14	0.78	lb	0.27	0.52
FIRG12	3/8	1/2	mm	27.0	27.0	62.5	32.0	69.2	116.2	29.0	29.0	19.7	Kg	0.128	0.237
			inch	1.06	1.06	2.46	1.26	2.72	4.57	1.14	1.14	0.78	lb	0.28	0.52
FIRG12A	1/2	1/2	mm	32.0	32.0	68.0	38.0	73.8	124.5	33.8	33.8	24.5	Kg	0.233	0.375
			inch	1.26	1.26	2.68	1.50	2.91	4.90	1.33	1.33	0.96	lb	0.51	0.83
FIRG34	1/2	3/4	mm	36.0	36.0	70.5	38.0	80.8	134.0	38.5	38.5	24.5	Kg	0.227	0.413
			inch	1.42	1.42	2.78	1.50	3.18	5.28	1.52	1.52	0.96	lb	0.50	0.91
FIRG34B	5/8	3/4	mm	36.0	36.0	70.5	42.0	78.5	131.4	38.5	38.5	27.0	Kg	0.268	0.479
			inch	1.42	1.42	2.78	1.65	3.09	5.17	1.52	1.52	1.06	lb	0.59	1.06
FIRG34A	3/4	3/4	mm	41.0	41.0	82.3	48.0	88.7	149.0	44.8	44.8	30.0	Kg	0.445	0.750
			inch	1.61	1.61	3.24	1.89	3.49	5.87	1.76	1.76	1.18	lb	0.98	1.65
FIRG100	3/4	1	mm	45.0	45.0	82.3	48.0	93.2	153.5	47.8	47.8	30.0	Kg	0.394	0.767
			inch	1.77	1.77	3.24	1.89	3.67	6.04	1.88	1.88	1.18	lb	0.87	1.69
FIRG114	1	1 1/4	mm	55.0	55.0	89.8	55.0	106.0	172.8	59.8	59.8	36.0	Kg	0.641	1.215
			inch	2.17	2.17	3.54	2.17	4.17	6.80	2.35	2.35	1.42	lb	1.41	2.68
FIRG112	1 1/2	1 1/2	mm	65.0	65.0	111.1	80.0	132.4	214.9	69.8	72.0	57.0	Kg	1.665	2.820
			inch	2.56	2.56	4.37	3.15	5.21	8.46	2.75	2.83	2.24	lb	3.67	6.22
FIRG200	2	2	mm	75.0	80.0	123.8	100.0	156.6	241.5	83.5	88.5	73.0	Kg	2.259	5.100
			inch	2.95	3.15	4.87	3.94	6.17	9.51	3.29	3.48	2.87	lb	4.98	11.24





## FIRG-NPT and SAE Thread\_ISO 16028

PART	BODY SIZE	PORT SIZE	THREAD TYPE	ORDER CODE	PART DESCRIPTION
<b>FIRG NPT THREAD</b>					
COUPLER	1/4	1/4	NPT	800801000	F. FIRG 14 NPT
NIPPLE	1/4	1/4	NPT	800801001	M. FIRG 14 NPT
COUPLER	3/8	1/2	NPT	800801002	F. FIRG 12 NPT
NIPPLE	3/8	1/2	NPT	800801003	M. FIRG 12 NPT
COUPLER	3/8	3/8	NPT	800801004	F. FIRG 38 NPT
NIPPLE	3/8	3/8	NPT	800801005	M. FIRG 38 NPT
COUPLER	1/2	1/2	NPT	800801006	F. FIRG 12A NPT
NIPPLE	1/2	1/2	NPT	800801007	M. FIRG 12A NPT
COUPLER	1/2	3/4	NPT	800801008	F. FIRG 34 NPT
NIPPLE	1/2	3/4	NPT	800801009	M. FIRG 34 NPT
COUPLER	5/8	3/4	NPT	800801010	F. FIRG 34B NPT
NIPPLE	5/8	3/4	NPT	800801011	M. FIRG 34B NPT
COUPLER	3/4	3/4	NPT	800801020	F. FIRG 34A NPT
NIPPLE	3/4	3/4	NPT	800801021	M. FIRG 34A NPT
COUPLER	3/4	1	NPT	800801012	F. FIRG 100 NPT
NIPPLE	3/4	1	NPT	800801013	M. FIRG 100 NPT
COUPLER	1	1 1/4	NPT	800801014	F. FIRG 114 NPT
NIPPLE	1	1 1/4	NPT	800801015	M. FIRG 114 NPT
COUPLER	1 1/2	1 1/2	NPT	800801016	F. FIRG 112 NPT
NIPPLE	1 1/2	1 1/2	NPT	800801017	M. FIRG 112 NPT
COUPLER	2	2	NPT	800801018	F. FIRG 200 NPT
NIPPLE	2	2	NPT	800801019	M. FIRG 200 NPT
<b>FIRG SAE THREAD</b>					
COUPLER	1/4	3/8	SAE	800804000	F. FIRG 14 3/8 SAE
NIPPLE	1/4	3/8	SAE	800804001	M. FIRG 14 3/8 SAE
COUPLER	3/8	1/2	SAE	800804002	F. FIRG 38 1/2 SAE
NIPPLE	3/8	1/2	SAE	800804003	M. FIRG 38 1/2 SAE
COUPLER	3/8	5/8	SAE	800804004	F. FIRG 12 5/8 SAE
NIPPLE	3/8	5/8	SAE	800804005	M. FIRG 12 5/8 SAE
COUPLER	1/2	5/8	SAE	800804006	F. FIRG 12A 5/8 SAE
NIPPLE	1/2	5/8	SAE	800804007	M. FIRG 12A 5/8 SAE
COUPLER	1/2	3/4	SAE	800804008	F. FIRG 34 SAE
NIPPLE	1/2	3/4	SAE	800804009	M. FIRG 34 SAE
COUPLER	5/8	3/4	SAE	800804010	F. FIRG 34B SAE
NIPPLE	5/8	3/4	SAE	800804011	M. FIRG 34B SAE
COUPLER	3/4	3/4	SAE	800804020	F. FIRG 34A SAE
NIPPLE	3/4	3/4	SAE	800804021	M. FIRG 34A SAE
COUPLER	3/4	1	SAE	800804012	F. FIRG 100 SAE
NIPPLE	3/4	1	SAE	800804013	M. FIRG 100 SAE
COUPLER	1	1 1/4	SAE	800804014	F. FIRG 114 SAE
NIPPLE	1	1 1/4	SAE	800804015	M. FIRG 114 SAE
COUPLER	1 1/2	1 1/2	SAE	800804016	F. FIRG 112 SAE
NIPPLE	1 1/2	1 1/2	SAE	800804017	M. FIRG 112 SAE
COUPLER	2	2	SAE	800804018	F. FIRG 200 SAE
NIPPLE	2	2	SAE	800804019	M. FIRG 200 SAE



COUPLER



NIPPLE

# ISO 16028 Interchange Couplings Connect Under Pressure



## Connect Under Pressure

### Series: APM

**Interchange:** ISO 16028

Male coupling APM series is the Stucchi solution to the problem of the connection in the presence of high internal residual pressure. Patented double internal security valve system in the male part allows the APM series to solve the problem of manual connections in the presence of high residual pressure. The APM series nipples are in accordance with ISO 16028.

- Zinc plated hardened steel
- Seals: Nitrile/Teflon standard
- NPT-SAE standard ports, others per request
- Connect with ISO 16028 coupler
- Connect up to 30 MPa/4350 psi residual pressure

### Overview

Stucchi APM series male couplings will connect by hand with residual pressure up to 30 MPa/4350 psi locked in the hydraulic circuit. It will connect with residual pressure without releasing any fluid into the environment. The mating circuit will need to be without residual pressure.

### Applications

Mobile equipment & attachment tools where exposure to the sun or temperature change causes pressure to develop due to thermal expansion of trapped fluid. Any application where static pressure can get locked into the system.

### Advantages

- Connects under high pressure by hand
- No air inclusion during connection
- Bi-directional Flow
- Elimination of fluid loss during connection or disconnection
- Easily cleaned before connection
- Interchangeable with ISO 16028

### Operation

To connect, wipe the mating surfaces clean, align the coupling and nipple, push together. To disconnect, pull back the sleeve on the female and the coupler's release.



DESCRIPTION	MAX. OPERATING PRESSURE				BURST PRESSURE				MAX. RESIDUAL PRESSURE DURING CONNECTION		SPILLAGE*
	COUPLED		MALE		COUPLED		MALE		MPa	psi	
	MPa	psi	MPa	psi	MPa	psi	MPa	psi			
APM9	35	5075	35	5075	100	14500	120	17400	30	4350	0.016
APM13	33	4785	33	4785	100	14500	120	17400	30	4350	0.010
APM15	33	4785	33	4785	100	14500	120	17400	30	4350	0.120
APM17	33	4785	33	4785	100	14500	120	17400	25	3625	0.180
APM21	30	4350	30	4350	80	11600	100	14500	25	3625	0.180
APM30	27	3915	27	3915	80	11600	100	14500	20	2900	0.400

\* SPILLAGE IS AN INDICATIVE VALUE OF THE FLUID LOSS PER COUPLE-UNCOUPLE CYCLE TESTED WITH FEMALE COUPLINGS "A" SERIES

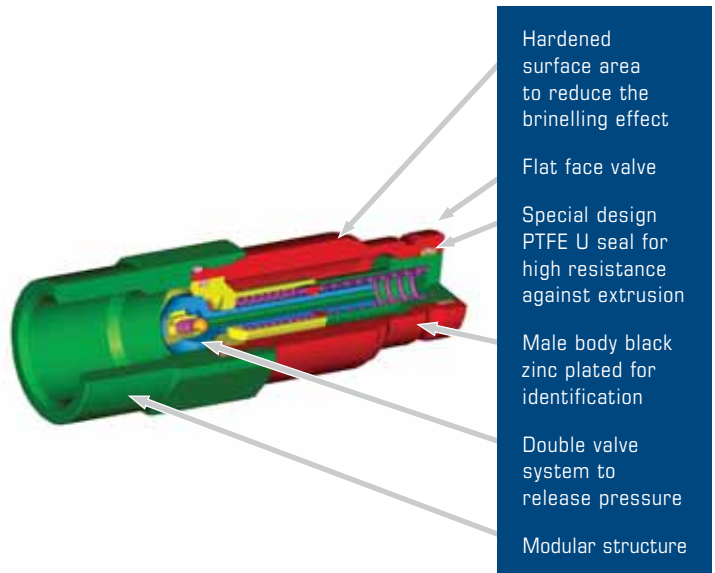
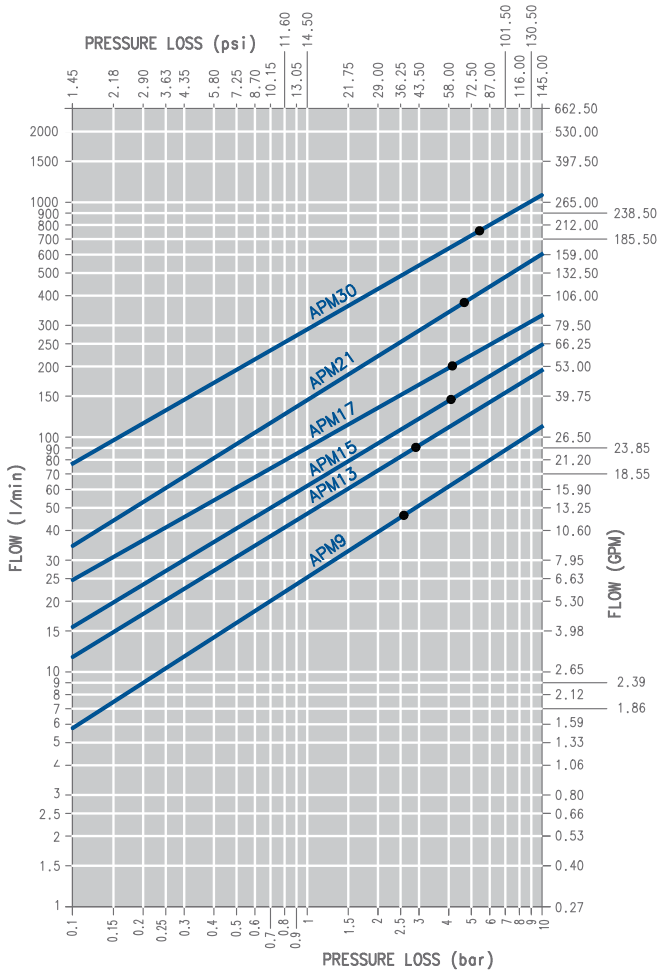

## Flat Face: APM Series Size Diagram

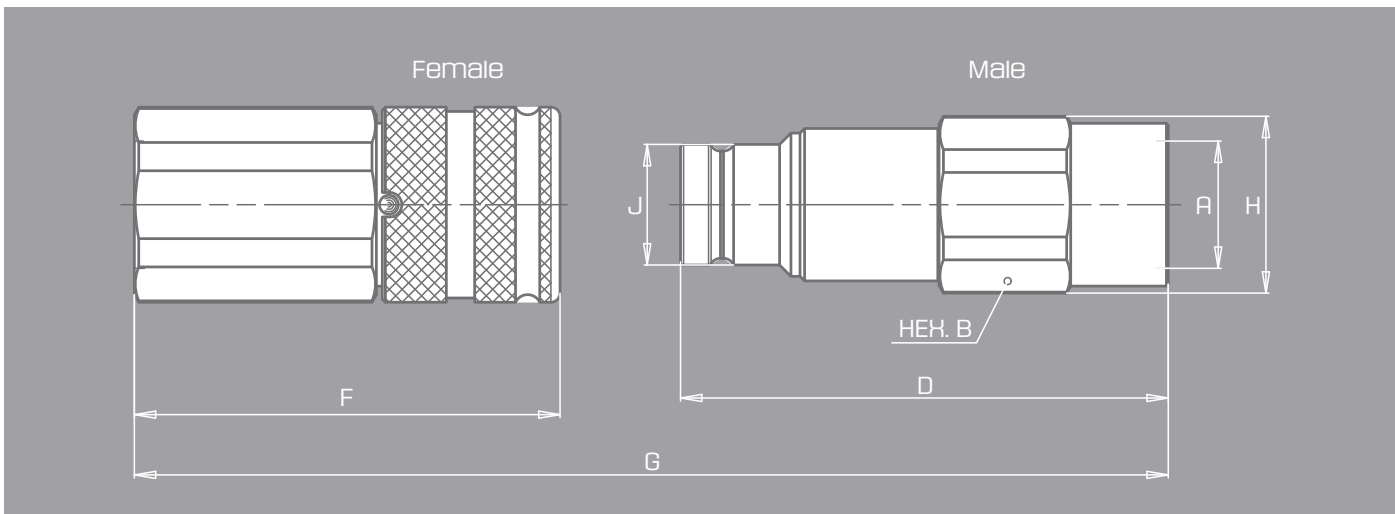

DESCRIPTION	BODY SIZE	A	UNIT	B	D	G	H	J	UNIT	WEIGHT
										MALE
APM9 3/8	3/8	3/8	mm	27.0	80.0	(F+D)-16	29.0	19.7	Kg	0.197
			inch	1.06	3.15	(F+D)-0,630	1.14	0.78		lb
APM9 1/2	3/8	1/2	mm	27.0	82.5	(F+D)-16	29.0	19.7	Kg	0.195
			inch	1.06	3.25	(F+D)-0,630	1.14	0.78		lb
APM13 1/2	1/2	1/2	mm	36.0	91.0	(F+D)-17,3	38.5	24.5	Kg	0.408
			inch	1.42	3.58	(F+D)-0,681	1.52	0.96		lb
APM13 3/4	1/2	3/4	mm	36.0	93.5	(F+D)-17,3	38.5	24.5	Kg	0.404
			inch	1.42	3.68	(F+D)-0,681	1.52	0.96		lb
APM15 3/4	5/8	3/4	mm	36.0	95.0	(F+D)-17,6	38.5	27.0	Kg	0.426
			inch	1.42	3.74	(F+D)-0,693	1.52	1.06		lb
APM17 1	3/4	1	mm	46.0	108.5	(F+D)-22	49.8	30.0	Kg	0.750
			inch	1.81	4.27	(F+D)-0,866	1.96	1.18		lb
APM21 1-1/4	1	1 1/4	mm	55.0	123.5	(F+D)-23	59.8	36.0	Kg	1.160
			inch	2.17	4.86	(F+D)-0,906	2.35	1.42		lb
APM30 1-1/2	1 1/2	1 1/2	mm	70.0	146.9	(F+D)-28,6	75.8	57.0	Kg	2.580
			inch	2.76	5.78	(F+D)-1,126	2.98	2.24		lb





**APM NPT, SAE and BSP Thread**\_Nipple Connect Under Pressure | ISO 16028

PART	BODY SIZE	PORT SIZE	THREAD TYPE	ORDER CODE	PART DESCRIPTION
<b>APM NPT THREAD</b>					
NIPPLE	3/8	3/8	NPT	805201001	M. APM 9 3/8 NPT
NIPPLE	3/8	1/2	NPT	805201003	M. APM 9 1/2 NPT
NIPPLE	1/2	1/2	NPT	805201005	M. APM 13 1/2 NPT
NIPPLE	1/2	3/4	NPT	805201007	M. APM 13 3/4 NPT
NIPPLE	5/8	3/4	NPT	805201009	M. APM 15 3/4 NPT
NIPPLE	3/4	3/4	NPT	805201019	M. APM 17 3/4 NPT
NIPPLE	3/4	1	NPT	805201011	M. APM 17 1 NPT
NIPPLE	1	1 1/4	NPT	805201017	M. APM 21 1 1/4 NPT
NIPPLE	1 1/2	1 1/2	NPT	805201015	M. APM 30 1 1/2 NPT
<b>APM SAE THREAD</b>					
NIPPLE	3/8	1/2	SAE	805204001	M. APM 9 1/2 SAE
NIPPLE	1/2	5/8	SAE	805204003	M. APM 13 5/8 SAE
NIPPLE	1/2	1/2	SAE	805204025	M. APM 13 1/2 SAE
NIPPLE	1/2	3/4	SAE	805204005	M. APM 13 3/4 SAE
NIPPLE	5/8	3/4	SAE	805204007	M. APM 15 3/4 SAE
NIPPLE	3/4	3/4	SAE	805204027	M. APM 17 3/4 SAE
NIPPLE	3/4	1	SAE	805204009	M. APM 17 1 SAE
NIPPLE	1	1 1/4	SAE	805204017	M. APM 21 1 1/4 SAE
NIPPLE	1 1/2	1 1/2	SAE	805204015	M. APM 30 1 1/2 SAE
<b>APM BULKHEAD THREAD</b>					
NIPPLE	1/2	5/8	ORFS BH	805213001	M. APM 13 5/8 ORFS BH
NIPPLE	1/2	5/8	JIC BH	805206001	M. APM 13 5/8 JIC BH
NIPPLE	1/2	1/2	JIC BH	805206003	M. APM 13 1/2 JIC BH
<b>APM BSP THREAD</b>					
NIPPLE	3/8	3/8	BSP	805200001	M. APM 9 3/8 BSP
NIPPLE	3/8	1/2	BSP	805200003	M. APM 9 1/2 BSP
NIPPLE	1/2	1/2	BSP	805200005	M. APM 13 1/2 BSP
NIPPLE	1/2	3/4	BSP	805200007	M. APM 13 3/4 BSP
NIPPLE	5/8	3/4	BSP	805200009	M. APM 15 3/4 BSP
NIPPLE	3/4	1	BSP	805200011	M. APM 17 1 BSP



# ISO 16028 Interchange Couplings Connect Under Pressure Female



## Connect Under Pressure

### Series: A-HD

**Interchange:** ISO 16028

Female coupling A-HD series is the Stucchi solution to the problem of the connection in the presence of high internal residual pressure. The Stucchi internal valving allows the A-HD series to solve the problem of manual connections in the presence of high residual pressure. The A-HD series female couplers are in accordance with ISO 16028.

Connect Under Residual Pressure Female Coupler:

- Visual ID: black ring on coupler face
- Zinc plated hardened steel
- Seals: Nitrile/Teflon standard
- NPT-SAE standard ports, others per request
- Connect with ISO 16028 nipple
- Connect up to 1595 psi residual pressure

### Overview

Stucchi A-HD (formerly ASP) series female couplings will connect by hand with residual pressure of 1595 psi locked in the hydraulic circuit. It will connect with residual pressure without releasing any fluid into the environment. The mating circuit will need to be without residual pressure.

### Applications

Mobile equipment and attachment tools where exposure to the sun, or temperature change causes pressure to develop due to thermal expansion of trapped fluid. Any application where static pressure can get locked into the system.

### Advantages

- Visual ID: black ring on face of coupler
- Connects under pressure by hand: 1595 psi
- No air inclusion during connection
- Bi-directional flow
- Elimination of fluid loss during connection or disconnection
- Easily cleaned before connection
- Interchangeable with ISO 16028

### Operation

To connect, wipe the mating surfaces clean, align the coupling and nipple, push together. To disconnect, pull back the sleeve on the female and the coupler's release.



STUCCHI SERIES	NOMINAL SIZE	ISO SIZE	MAX OPERATING PRESSURE COUPLED	MAX OPERATING PRESSURE COUPLED
	inches	mm	MPa	psi
A13HD	1/2	12.5	33	4714

**A-HD NPT, SAE and JIC Thread**\_Female Connect Under Pressure | ISO 16028

PART	BODY SIZE	PORT SIZE	THREAD TYPE	ORDER CODE	PART DESCRIPTION
<b>A-HD NPT THREAD</b>					
COUPLER	1/2	1/2	NPT	806801000	F. A13HD 1/2 NPT
COUPLER	1/2	3/4	NPT	806801002	F. A13HD 3/4 NPT
<b>A-HD SAE THREAD</b>					
COUPLER	1/2	3/4	SAE	806804000	F. A13HD 3/4 SAE
COUPLER	1/2	5/8	SAE	806804006	F. A13HD 5/8 SAE
COUPLER	1/2	1/2	SAE	808304016	F. A13HD 1/2 SAE
<b>A-HD JIC THREAD</b>					
COUPLER	1/2	5/8	JIC BH	806806000	F. A13HD 5/8 JIC BH



# ISO 16028 Interchange Flat Face Push Pull



## Series: Push Pull Interchange: ISO 16028

The Push Pull coupler is built on the "A" Premier platform, thus allowing breakaway capabilities when the coupler is unintentionally left coupled. It is mounted in a clamp fixture that is designed to be fixed-mounted to the structure and when pulled apart in line with the coupler, the PPC Series coupler will breakaway. It is recommended to use the APM series nipple in conjunction with this series for mobile applications.

## Flat Face: Push Pull

BODY SIZE	PORT SIZE	THREAD TYPE	ORDER CODE	PART DESCRIPTION
3/8	1/2	SAE	PPC0608FO	PUSH PULL FF 3/8 X 1/2 SAE
1/2	1/2	NPT	PPC0808FP	PUSH PULL FF 1/2 X 1/2 NPT
1/2	3/4	SAE	PPC0812FO	PUSH PULL FF 1/2 X 3/4 SAE
1/2	3/4	NPT	PPC0812FP	PUSH PULL FF 1/2 X 3/4 NPT
5/8	3/4	SAE	PPC1012FO	PUSH PULL FF 5/8 X 3/4 SAE
5/8	3/4	NPT	PPC1012FP	PUSH PULL FF 5/8 X 3/4 NPT
3/4	3/4	NPT	PPC1212FP	PUSH PULL FF 3/4 X 3/4 NPT
3/4	1	NPT	PPC1216FP	PUSH PULL FF 3/4 X 1 NPT

PPC SERIES CONSISTS OF COUPLER AND CLAMP ASSEMBLY COMPONENTS

### Applications

- Refuse compactor and power units
- Trailer dump connections
- Snow plow application
- Agricultural implements





## Flat Face: 316 Stainless Steel

### Series: FL Series 316 Stainless Steel

**Interchange:** ISO 16028

The FL variation of the FIRG series is the Stucchi solution for high corrosion applications. The resistance to corrosion and excellent fatigue life make this product ideal for applications in the chemical, pharmaceutical, food and offshore industries. The interchangeability of FL series couplings is in accordance with ISO 16028.

#### Overview

The FL couplings are manufactured in stainless steel AISI 316; standard seals are Viton/Fluorocarbon with the option of other seal materials upon request for use with various fluids and operating temperatures. The features of flat face couplings in stainless steel to eliminate leakage during connection/disconnection reduce contamination in the circuit, and offer optimal resistance to corrosion, making the FL series ideal for applications such as: offshore, marine, industrial equipment, chemical, pharmaceutical and food processing.

#### Features & Options

- No air inclusion during connection
- Flat face can easily be cleaned limiting contamination into system
- Non-spill design eliminates leaks
- Minimal pressure drop design





# ISO 16028 Interchange Couplings 316 Stainless Steel

DESCRIPTION	SIZE	ISO SIZE	MAX OPERATING PRESSURE						BURST PRESSURE						SPILLAGE*
			COUPLED		MALE		FEMALE		COUPLED		MALE		FEMALE		
			MPa	psi	MPa	psi	MPa	psi	MPa	psi	MPa	psi	MPa	psi	
FL4	1/8	-	35	5075	35	5075	33	4785	140	20300	140	20300	120	17400	0.005
FL7	1/4	6.3	35	5075	35	5075	12	1740	140	20300	120	17400	48	6960	0.006
FL9	3/8	10.0	35	5075	35	5075	15	2175	140	20300	120	17400	60	8700	0.012
FL13	1/2	12.5	35	5075	35	5075	15	2175	120	17400	110	15950	60	8700	0.020
FL15	5/8	16.0	35	5075	30	4350	12	1740	120	17400	100	14500	48	6960	0.026
FL17	3/4	19.0	33	4785	28	4060	12	1740	100	14500	80	11600	48	6960	0.032
FL21	1	25.0	28	4060	28	4060	12	1740	90	13050	80	11600	48	6960	0.035
FL27	1 1/2	-	23	3335	23	3335	8	1160	80	11600	70	10150	32	4640	0.050
FL45	2	-	15	2175	15	2175	7	1015	60	8700	60	8700	28	4060	0.100

\* SPILLAGE IS AN INDICATIVE VALUE OF THE FLUID LOSS PER COUPLE-UNCUPLE CYCLE

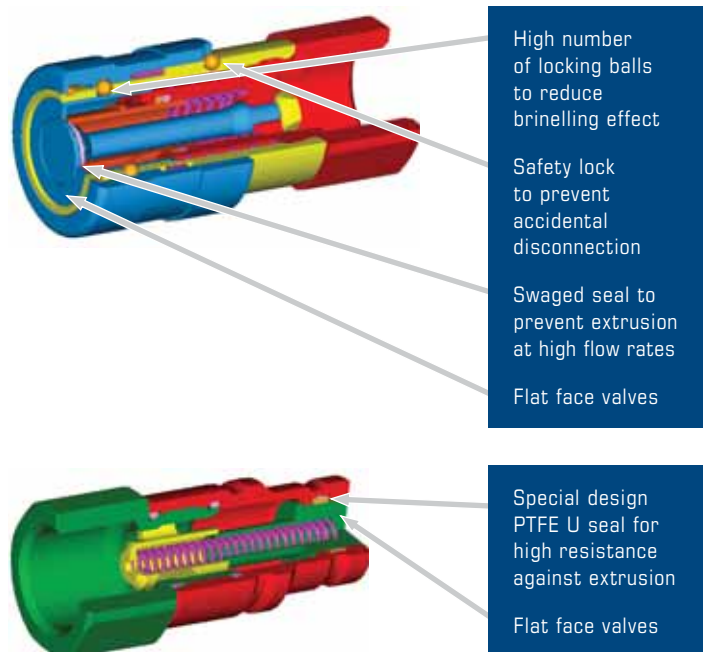
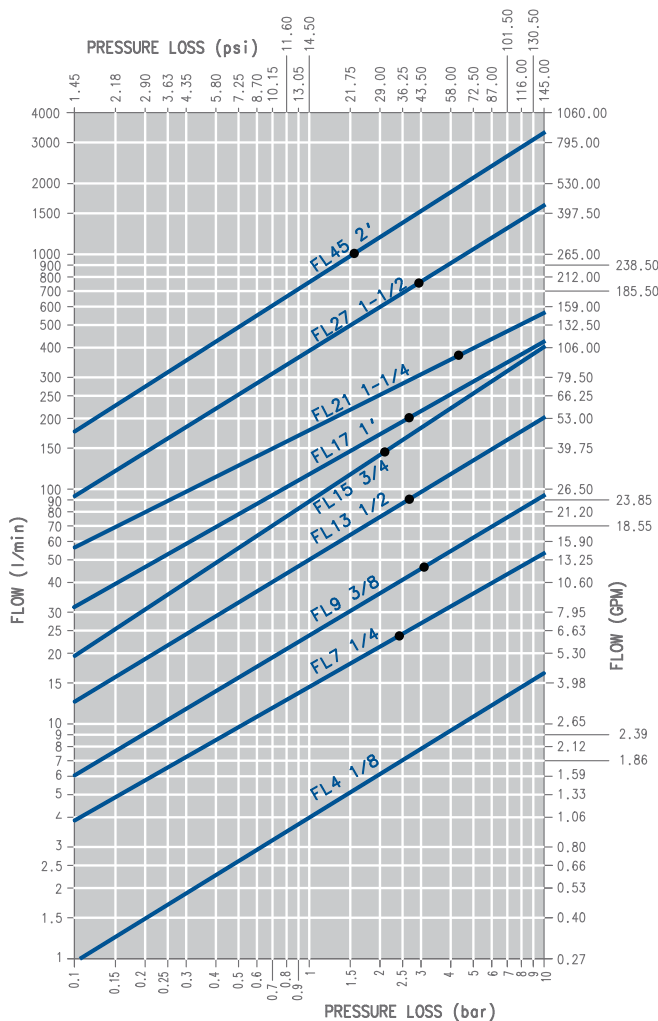



# Flat Face: 316 Stainless Steel Series Size Diagram

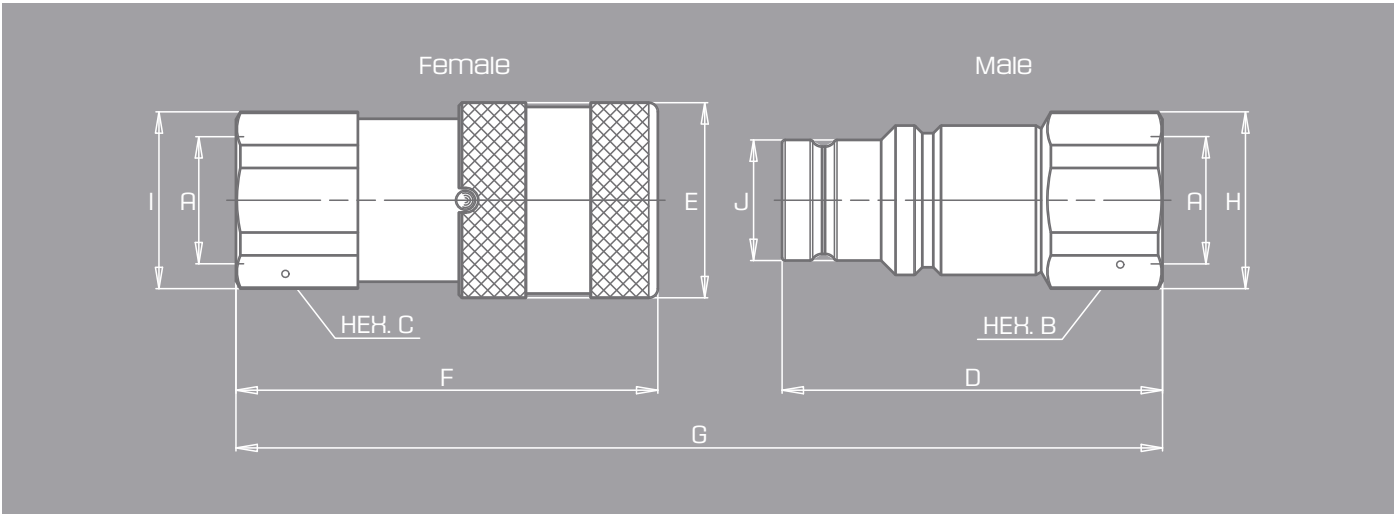

DESCRIPTION	BODY SIZE	A	UNIT	B	C	D	E	F	G	H	I	J	UNIT	WEIGHT	
														MALE	FEMALE
FL4 1/8	1/8	1/8	mm	17.0	19.0	36.3	20.0	40.0	68.4	18.5	20.5	11.6	Kg	0.037	0.074
			inch	0.67	0.75	1.43	0.79	1.57	2.69	0.73	0.81	0.46	lb	0.08	0.16
FL7 1/4	1/4	1/4	mm	22.0	22.0	49.4	28.0	48.3	86.7	23.8	23.8	16.1	Kg	0.098	0.142
			inch	0.87	0.87	1.94	1.10	1.90	3.41	0.94	0.94	0.63	lb	0.22	0.31
FL9 3/8	3/8	3/8	mm	24.0	27.0	59.9	32.0	64.2	108.6	26.0	29.0	19.7	Kg	0.124	0.245
			inch	0.94	1.06	2.36	1.26	2.53	4.28	1.02	1.14	0.78	lb	0.27	0.54
FL9 1/2	3/8	1/2	mm	27.0	27.0	62.4	32.0	69.2	116.1	29.0	29.0	19.7	Kg	0.120	0.242
			inch	1.06	1.06	2.46	1.26	2.72	4.57	1.14	1.14	0.78	lb	0.26	0.53
FL13 1/2	1/2	1/2	mm	32.0	32.0	70.5	38.0	73.8	127.0	33.8	33.8	24.5	Kg	0.259	0.378
			inch	1.26	1.26	2.78	1.50	2.91	5.00	1.33	1.33	0.96	lb	0.57	0.83
FL13 3/4	1/2	3/4	mm	36.0	36.0	70.5	38.0	80.8	134.0	38.5	38.5	24.5	Kg	0.255	0.375
			inch	1.42	1.42	2.78	1.50	3.18	5.28	1.52	1.52	0.96	lb	0.56	0.83
FL15 3/4	5/8	3/4	mm	36.0	36.0	70.5	42.0	80.9	133.8	38.5	38.5	27.0	Kg	0.282	0.492
			inch	1.42	1.42	2.78	1.65	3.19	5.27	1.52	1.52	1.06	lb	0.62	1.08
FL17 1	3/4	1	mm	46.0	46.0	82.2	48.0	92.9	153.3	49.5	49.5	30.0	Kg	0.432	0.795
			inch	1.81	1.81	3.24	1.89	3.66	6.04	1.95	1.95	1.18	lb	0.95	1.75
FL21 1 1/4	1	1 1/4	mm	55.0	55.0	90.0	55.0	106.2	173.0	59.8	59.8	36.0	Kg	0.672	1.226
			inch	2.17	2.17	3.54	2.17	4.18	6.81	2.35	2.35	1.42	lb	1.48	2.70
FL27 1 1/2	1 1/2	1 1/2	mm	70.0	65.0	111.0	80.0	132.4	214.8	76.0	72.0	57.0	Kg	1.890	2.908
			inch	2.76	2.56	4.37	3.15	5.21	8.46	2.99	2.83	2.24	lb	4.17	6.41
FL45 2	2	2	mm	75.0	80.0	123.8	100.0	156.6	241.5	83.5	88.5	73.0	Kg	2.290	5.230
			inch	2.95	3.15	4.87	3.94	6.17	9.51	3.29	3.48	2.87	lb	5.05	11.53

# ISO 16028 Interchange Couplings 316 Stainless Steel



COUPLER



NIPPLE

## FL 316 NPT, SAE Thread\_Stainless Steel | ISO 16028

PART	BODY SIZE	PORT SIZE	THREAD TYPE	ORDER CODE	PART DESCRIPTION
<b>FL NPT THREAD</b>					
COUPLER	1/8	1/8	NPT	802401118	F. FL4 1/8 NPT
NIPPLE	1/8	1/8	NPT	802401119	M. FL4 1/8 NPT
COUPLER	1/4	1/4	NPT	802401100	F. FL7 1/4 NPT
NIPPLE	1/4	1/4	NPT	802401101	M. FL7 1/4 NPT
COUPLER	3/8	3/8	NPT	802401102	F. FL9 3/8 NPT
NIPPLE	3/8	3/8	NPT	802401103	M. FL9 3/8 NPT
COUPLER	3/8	1/2	NPT	802401104	F. FL9 1/2 NPT
NIPPLE	3/8	1/2	NPT	802401105	M. FL9 1/2 NPT
COUPLER	1/2	1/2	NPT	802401106	F. FL13 1/2 NPT
NIPPLE	1/2	1/2	NPT	802401107	M. FL13 1/2 NPT
COUPLER	1/2	3/4	NPT	802401108	F. FL13 3/4 NPT
NIPPLE	1/2	3/4	NPT	802401109	M. FL13 3/4 NPT
COUPLER	5/8	3/4	NPT	802401110	F. FL15 3/4 NPT
NIPPLE	5/8	3/4	NPT	802401111	M. FL15 3/4 NPT
COUPLER	3/4	1	NPT	802401112	F. FL17 1 NPT
NIPPLE	3/4	1	NPT	802401113	M. FL17 1 NPT
COUPLER	1	1 1/4	NPT	802401114	F. FL21 1 1/4 NPT
NIPPLE	1	1 1/4	NPT	802401115	M. FL21 1 1/4 NPT
COUPLER	1 1/2	1 1/2	NPT	802401116	F. FL27 1 1/2 NPT
NIPPLE	1 1/2	1 1/2	NPT	802401117	M. FL27 1 1/2 NPT
COUPLER	2	2	NPT	802401120	F. FL45 2 NPT
NIPPLE	2	2	NPT	802401121	M. FL45 2 NPT
<b>FL SAE THREAD</b>					
COUPLER	1/8	3/16	SAE	802404100	F. FL4 3/16 SAE
NIPPLE	1/8	3/16	SAE	802404101	M. FL4 3/16 SAE
COUPLER	1/4	3/8	SAE	802404102	F. FL7 3/8 SAE
NIPPLE	1/4	3/8	SAE	802404103	M. FL7 3/8 SAE
COUPLER	3/8	1/2	SAE	802404104	F. FL9 1/2 SAE
NIPPLE	3/8	1/2	SAE	802404105	M. FL9 1/2 SAE
COUPLER	3/8	5/8	SAE	802404106	F. FL9 5/8 SAE
NIPPLE	3/8	5/8	SAE	802404107	M. FL9 5/8 SAE
COUPLER	1/2	5/8	SAE	802404108	F. FL13 5/8 SAE
NIPPLE	1/2	5/8	SAE	802404109	M. FL13 5/8 SAE
COUPLER	1/2	1/2	SAE	802404110	F. FL13 1/2 SAE
NIPPLE	1/2	1/2	SAE	802404111	M. FL13 1/2 SAE
COUPLER	1/2	3/4	SAE	802404112	F. FL13 3/4 SAE
NIPPLE	1/2	3/4	SAE	802404113	M. FL13 3/4 SAE
COUPLER	5/8	3/4	SAE	802404114	F. FL15 3/4 SAE
NIPPLE	5/8	3/4	SAE	802404115	M. FL15 3/4 SAE
COUPLER	3/4	1	SAE	802404116	F. FL17 1 SAE
NIPPLE	3/4	1	SAE	802404117	M. FL17 1 SAE
COUPLER	1	1 1/4	SAE	802404118	F. FL21 1 1/4 SAE
NIPPLE	1	1 1/4	SAE	802404119	M. FL21 1 1/4 SAE
COUPLER	1 1/2	1 1/2	SAE	802404120	F. FL27 1 1/2 SAE
NIPPLE	1 1/2	1 1/2	SAE	802404121	M. FL27 1 1/2 SAE
COUPLER	2	2	SAE	802404122	F. FL45 200 SAE
NIPPLE	2	2	SAE	802404123	M. FL45 200 SAE



## Flat Face: QPQ Plating

**Series:** FIRG Q

**Interchange:** ISO 16028

Q variation of the FIRG series is the integration of the QPQ plating technology combined with a coupler constructed of stainless internal parts and carbon steel external parts of the flat face quick couplings. In relatively corrosive, alkaline environments they are an excellent alternative to the more expensive stainless steel quick couplings and demonstrate a much higher operational pressure performance. The interchangeability of FIRG Q series couplings is in accordance with ISO 16028.

- Material: high resistance carbon steel treated with QPQ
- Valve parts in stainless steel
- Springs in AISI 302 SS
- Locking balls in AISI 420
- Seals: Nitrile, EPDM, Viton, etc.

### Overview

The FIRG Q flat face couplings series is the solution for mildly corrosive environments and/or for relatively corrosive fluid transfer (i.e. sweet water, water and glycol etc). The internal valve material is stainless steel AISI303 and can be supplied with a variety of seals for fluid compatibility and operating temperature requirements. The combined features of FIRG Q series are ideal for several applications, mainly in the industrial field.

### Applications

FIRG Q series are suitable for low or medium corrosive fluids. steel mills, tire manufacturing, state or municipal right-of-way spraying.

### Features & Options

- Couplings: internal stainless steel parts, external carbon with QPQ plating
- Seals: Nitrile with Teflon anti-extrusion ring. Viton, Kalrez, EPDM upon request
- Ports: NPT, SAE



# ISO 16028 Interchange Couplings Flat Face with QPQ Plating

## Data for NBR, Viton, EPDM Seals

DESCRIPTION	SIZE	MAX. OPERATING PRESSURE COUPLED		BURST PRESSURE						SPILLAGE*
		MPa	psi	COUPLED		MALE		FEMALE		
				MPa	psi	MPa	psi	MPa	psi	MPa
FIRG14Q	1/4	30	4350	120	17400	120	17400	48	6960	0.006
FIRG38Q-12Q	3/8	30	4350	120	17400	120	17400	60	8700	0.012
FIRG12A-34Q	1/2	25	3625	100	14500	100	14500	48	6960	0.020
FIRG34BQ	5/8	25	3625	100	14500	100	14500	48	6960	0.026
FIRG100Q	3/4	25	3625	100	14500	90	13050	40	5800	0.032
FIRG114Q	1	25	3625	100	14500	90	13050	40	5800	0.035
FIRG112Q	1 1/2	20	2900	60	8700	60	8700	32	4640	0.050
FIRG200Q	2	20	2900	60	8700	60	8700	32	4640	0.100

\* SPILLAGE IS AN INDICATIVE VALUE OF THE FLUID LOSS PER COUPLE-UNCUPLE CYCLE

## Data for FIRG Q w/Kalrez Seals High Temp Applications

DESCRIPTION	SIZE	MAX. OPERATING PRESSURE COUPLED		BURST PRESSURE						SPILLAGE*
		MPa	psi	COUPLED		MALE		FEMALE		
				MPa	psi	MPa	psi	MPa	psi	MPa
FIRG12A-34QK	1/2	5	725	100	14500	100	14500	48	6960	0.020
FIRG34BQK	5/8	5	725	100	14500	100	14500	40	5800	0.026
FIRG100QK	3/4	5	725	100	14500	90	13050	60	8700	0.032
FIRG114QK	1	5	725	100	14500	90	13050	60	8700	0.035
FIRG112QK	1 1/2	5	725	40	5800	40	5800	32	4640	0.050
FIRG200QK	2	5	725	40	5800	40	5800	32	4640	0.100

\* SPILLAGE IS AN INDICATIVE VALUE OF THE FLUID LOSS PER COUPLE-UNCUPLE CYCLE

KALREZ SEALS: FROM -25°C TO 300°C (FROM -13 °F TO 572 °F).

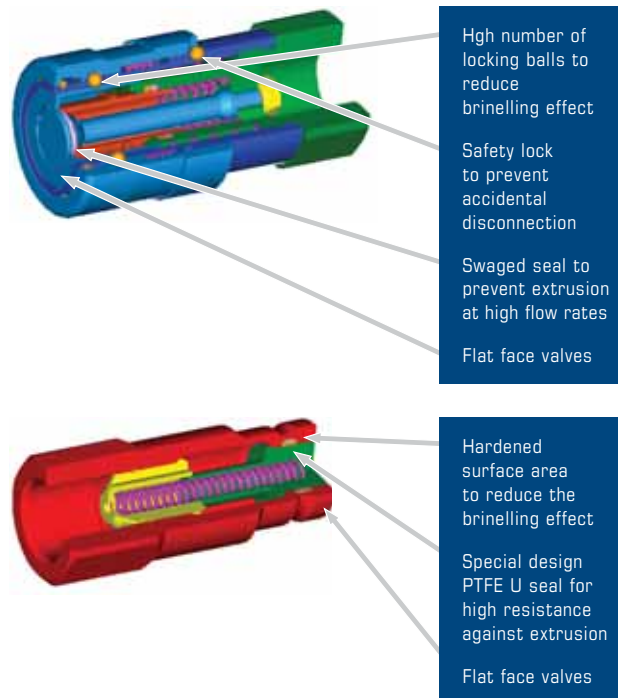
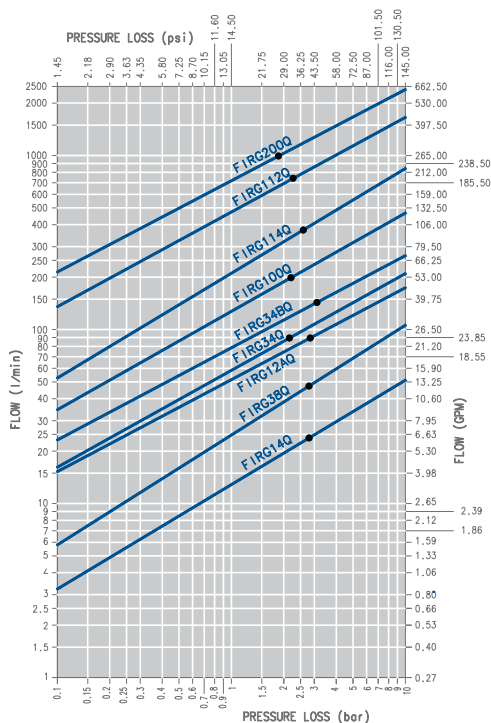





## Flat Face: QPQ Plating Series Size Diagram

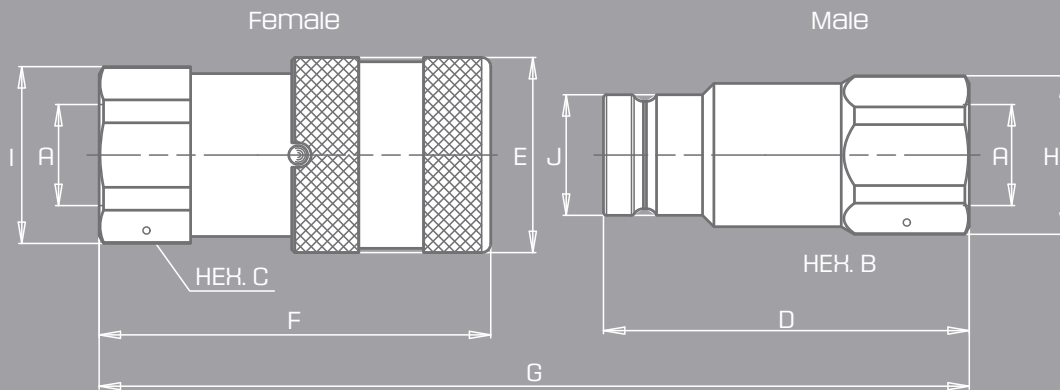

DESCRIPTION	BODY SIZE	A	UNIT	B	C	D	E	F	G	H	I	J	UNIT	WEIGHT	
														MALE	FEMALE
FIRG14Q	1/4	1/4	mm	22.0	22.0	47.9	28.0	48.1	85.2	23.8	24.0	16.1	Kg	0.085	0.135
			inch	0.87	0.87	1.89	1.10	1.89	3.35	0.94	0.94	0.63	lb	0.19	0.30
FIRG38Q	3/8	3/8	mm	24.0	27.0	60.0	32.0	64.2	108.7	26.0	29.0	19.7	Kg	0.120	0.240
			inch	0.94	1.06	2.36	1.26	2.53	4.28	1.02	1.14	0.78	lb	0.26	0.53
FIRG12Q	3/8	1/2	mm	27.0	27.0	62.5	32.0	69.2	116.2	29.0	29.0	19.7	Kg	0.130	0.236
			inch	1.06	1.06	2.46	1.26	2.72	4.57	1.14	1.14	0.78	lb	0.29	0.52
FIRG12AQ	1/2	1/2	mm	32.0	32.0	68.0	38.0	73.8	124.5	33.8	33.8	24.5	Kg	0.239	0.384
			inch	1.26	1.26	2.68	1.50	2.91	4.90	1.33	1.33	0.96	lb	0.53	0.85
FIRG34Q	1/2	3/4	mm	36.0	36.0	70.5	38.0	80.8	134.0	38.5	38.5	24.5	Kg	0.227	0.430
			inch	1.42	1.42	2.78	1.50	3.18	5.28	1.52	1.52	0.96	lb	0.50	0.95
FIRG34BQ	5/8	3/4	mm	36.0	36.0	70.5	42.0	78.5	131.4	38.5	38.5	27.0	Kg	0.268	0.473
			inch	1.42	1.42	2.78	1.65	3.09	5.17	1.52	1.52	1.06	lb	0.59	1.04
FIRG100Q	3/4	1	mm	45.0	45.0	82.3	48.0	93.2	153.5	47.8	47.8	30.0	Kg	0.406	0.765
			inch	1.77	1.77	3.24	1.89	3.67	6.04	1.88	1.88	1.18	lb	0.90	1.69
FIRG114Q	1	1 1/4	mm	55.0	55.0	89.8	55.0	106.0	172.8	59.8	59.8	36.0	Kg	0.645	1.240
			inch	2.17	2.17	3.54	2.17	4.17	6.80	2.35	2.35	1.42	lb	1.42	2.73
FIRG112Q	1 1/2	1 1/2	mm	70.0	65.0	111.0	80.0	132.4	214.8	76.0	72.0	57.0	Kg	1.865	2.823
			inch	2.76	2.56	4.37	3.15	5.21	8.46	2.99	2.83	2.24	lb	4.11	6.22
FIRG200Q	2	2	mm	75.0	80.0	123.8	100.0	156.6	241.5	83.5	88.5	73.0	Kg	2.259	5.100
			inch	2.95	3.15	4.87	3.94	6.17	9.51	3.29	3.48	2.87	lb	4.98	11.24

# ISO 16028 Interchange Couplings Flat Face with QPQ Plating

## FIRG Q NPT Thread Flat Face with QPQ Plating | ISO 16028



COUPLER



NIPPLE

PART	BODY SIZE	PORT SIZE	THREAD TYPE	ORDER CODE	PART DESCRIPTION
FIRG Q NPT THREAD					
COUPLER	1/4	1/4	NPT	800901000	F. FIRG 14 QN NPT
NIPPLE	1/4	1/4	NPT	800901001	M. FIRG 14 QN NPT
COUPLER	3/8	3/8	NPT	800901002	F. FIRG 38 QN NPT
NIPPLE	3/8	3/8	NPT	800901003	M. FIRG 38 QN NPT
COUPLER	3/8	1/2	NPT	800901004	F. FIRG 12 QN NPT
NIPPLE	3/8	1/2	NPT	800901005	M. FIRG 12 QN NPT
COUPLER	1/2	1/2	NPT	800901006	F. FIRG 12A QN NPT
NIPPLE	1/2	1/2	NPT	800901007	M. FIRG 12A QN NPT
COUPLER	1/2	3/4	NPT	800901008	F. FIRG 34 QN NPT
NIPPLE	1/2	3/4	NPT	800901009	M. FIRG 34 QN NPT
COUPLER	5/8	3/4	NPT	800901010	F. FIRG 34B QN NPT
NIPPLE	5/8	3/4	NPT	800901011	M. FIRG 34B QN NPT
COUPLER	3/4	1	NPT	800901012	F. FIRG 100 QN NPT
NIPPLE	3/4	1	NPT	800901013	M. FIRG 100 QN NPT
COUPLER	1	1 1/4	NPT	800901014	F. FIRG 114 QN NPT
NIPPLE	1	1 1/4	NPT	800901015	M. FIRG 114 QN NPT
COUPLER	1 1/2	1 1/2	NPT	800901016	F. FIRG 112 QN NPT
NIPPLE	1 1/2	1 1/2	NPT	800901017	M. FIRG 112 QN NPT
COUPLER	2	2	NPT	800901018	F. FIRG 200 QN NPT
NIPPLE	2	2	NPT	800901019	M. FIRG 200 QN NPT



## Flat Face: Special Z Plating

**Series: "A"**

**Interchange: ISO 16028**

"A" series couplings are in accordance with ISO 16028. The Z version is an integration of plating technology that exceeds the ISO salt spray test. Standard zinc plating is guaranteed for 72 hours before red spotting. The Z version plating is designed to exceed 400 hours before the appearance of red spotting in the same ISO salt spray test.

- Seals: Nitrile & Teflon anti-extrusion
- Nipple: hardened steel reduces brinnelling
- 12 to 20 balls to increase the male bearing points & decrease the brinnelling effect
- Modular structure for multiple port option
- Lock system stops unwanted disconnect
- Exceeds Impulse test of ISOA-7241 test

### Overview

"A" series or Premier Z series offers higher pressure ratings, superior flow ratings, lower pressure drop compared to competitors' products. Specialized plating for high corrosion resistance designed to exceed 400 hours in the ISO salt spray test before the appearance of red spots.

### Applications

Flat face couplers are specifically designed for applications needing no-leak performance. The mating faces are easily cleaned before connecting, making it the ideal solution for limiting contamination in a hydraulic circuit. The Z version design allows for applications involving medium to high corrosion environments.



# ISO 16028 Interchange Couplings Flat Face with Special Z Plating

## Series A NPT Thread Flat Face with Iron Zinc Plating | ISO 16028

PART	BODY SIZE	PORT SIZE	THREAD TYPE	ORDER CODE	PART DESCRIPTION
<b>SERIES A NPT THREAD</b>					
COUPLER	3/8	3/8	NPT	807601006	F. A9ZF 3/8 NPT
NIPPLE	3/8	3/8	NPT	807601007	M. A9ZF 3/8 NPT
COUPLER	1/2	1/2	NPT	807601008	F. A13ZF 1/2 NPT
NIPPLE	1/2	1/2	NPT	807601009	M. A13ZF 1/2 NPT
COUPLER	1/2	3/4	NPT	807601010	F. A13ZF 3/4 NPT
NIPPLE	1/2	3/4	NPT	807601011	M. A13ZF 3/4 NPT
COUPLER	5/8	3/4	NPT	807601012	F. A15ZF 3/4 NPT
NIPPLE	5/8	3/4	NPT	807601013	M. A15ZF 3/4 NPT



COUPLER



NIPPLE

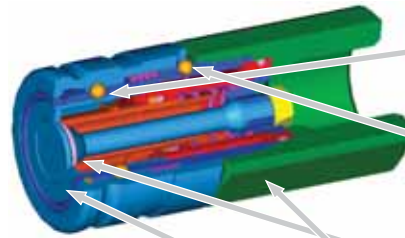
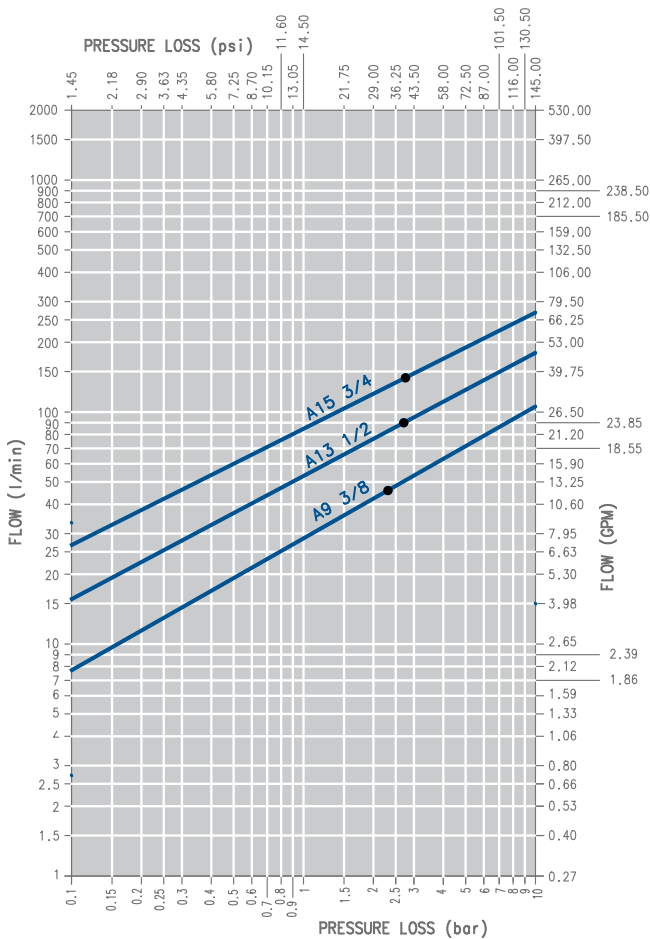

High number of locking balls to reduce brinelling effect

Safety lock to prevent accidental disconnection

Swaged seal to prevent extrusion at high flow rates

Flat face valves

High corrosion plating

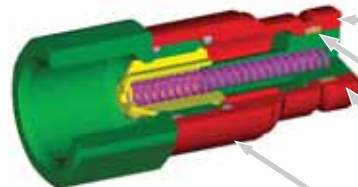

Hardened surface area to reduce the brinelling effect

Special design PTFE U seal for high resistance against extrusion

Flat face valves

High corrosion plating



## Flat Face: Special Z Plating Series Size Diagram

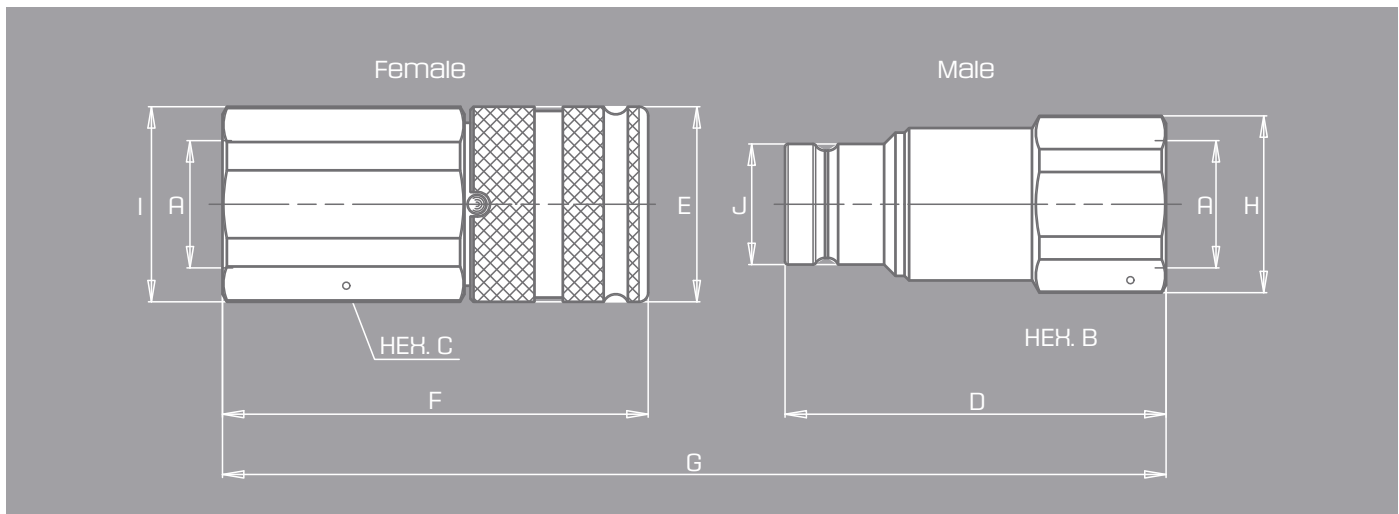

DESCRIPTION	BODY SIZE	A	UNIT	B	C	D	E	F	G	H	I	J	UNIT	WEIGHT	
														MALE	FEMALE
A9	3/8	3/8	mm	27.0	30.0	60.0	32.0	64.8	108.8	29.0	32.0	19.7	Kg	0.150	0.273
			inch	1.06	1.18	2.36	1.26	2.55	4.28	1.14	1.26	0.78	lb	0.33	0.60
A9	3/8	1/2	mm	27.0	30.0	62.5	32.0	69.8	116.3	29.0	32.0	19.7	Kg	0.138	0.278
			inch	1.06	1.18	2.46	1.26	2.75	4.58	1.14	1.26	0.78	lb	0.30	0.61
A13	1/2	1/2	mm	36.0	36.0	68.0	38.0	76.8	127.5	40.0	40.0	24.5	Kg	0.295	0.452
			inch	1.42	1.42	2.68	1.50	3.02	5.02	1.57	1.57	0.96	lb	0.65	1.00
A13	1/2	3/4	mm	36.0	36.0	70.5	38.0	83.8	137.0	40.0	40.0	24.5	Kg	0.273	0.469
			inch	1.42	1.42	2.78	1.50	3.30	5.39	1.57	1.57	0.96	lb	0.60	1.03
A15	5/8	3/4	mm	36.0	41.0	73.0	42.0	84.0	139.4	38.5	44.8	27.0	Kg	0.292	0.631
			inch	1.42	1.61	2.87	1.65	3.31	5.49	1.52	1.76	1.06	lb	0.64	1.39



# Flat Face Coupling 10,000 Working Pressure



## 10,000 Working Pressure

### Series: A-HP

**Interchange:** None Proprietary Coupling

General data: HP is the Stucchi solution to high pressure leak-free applications with a 10,000 psi working pressure.

Features Include:

- Auto lock sleeve to eliminate accidental disconnection
- Does not interchange with lower pressure couplings to avoid misuse
- Color coded identification option available upon request (see inset photo)



### Overview

The Stucchi HP series offers a patented safety system to prevent accidental disconnection. This patented sleeve system automatically rotates the sleeve when connected, engaging the safety lock mechanism. To disconnect: the coupler sleeve must be turned and aligned between the release notch and locking pin. A simple yet highly effective safety system.

### Applications

- Emergency cutting tools
- Hydraulic wrenches, tools

### Advantages

- Locking sleeve eliminates accidental disconnection
- Low pressure drop
- No air inclusion during connection
- Flat face design limits leakage
- Easy to clean, eliminate contamination of hydraulic circuit
- Bi-directional flow
- Seals: Nitrile o-ring with anti-extrusion rings in specially shaped Teflon (PTFE)



DESCRIPTION	SIZE	MAX. OPERATING PRESSURE COUPLED		BURST PRESSURE						SPILLAGE*
				COUPLED		MALE		FEMALE		
		MPa	psi	MPa	psi	MPa	psi	MPa	psi	
A4HP	1/8	72	10440	160	23200	160	23200	160	23200	0.040
A5HP	1/4	72	10440	200	29000	200	29000	150	21750	0.020
A9HP	3/8	72	10440	180	26100	200	29000	125	18125	0.020

\* SPILLAGE IS AN INDICATIVE VALUE OF THE FLUID LOSS PER COUPLE-UNCUPLE CYCLE

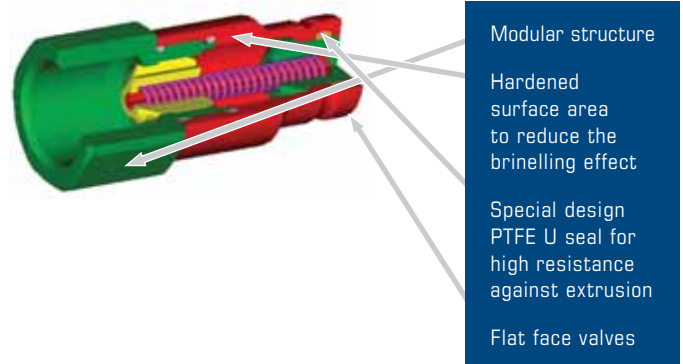
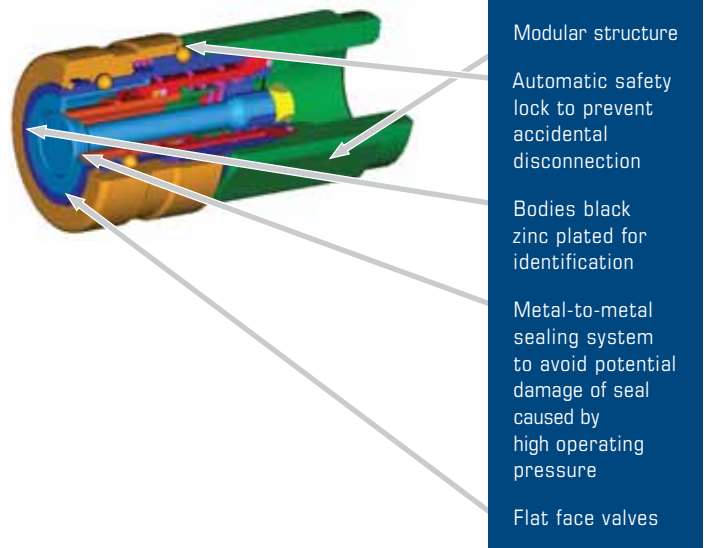
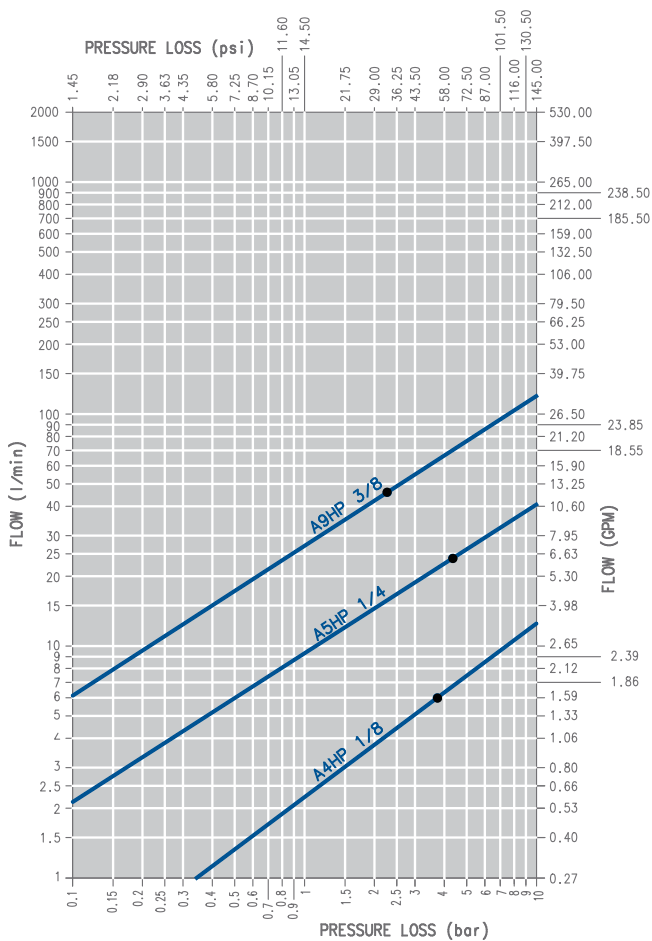

# Flat Face Coupling 10,000 Working Pressure

## Flat Face: 10,000 Working Pressure Size Diagram

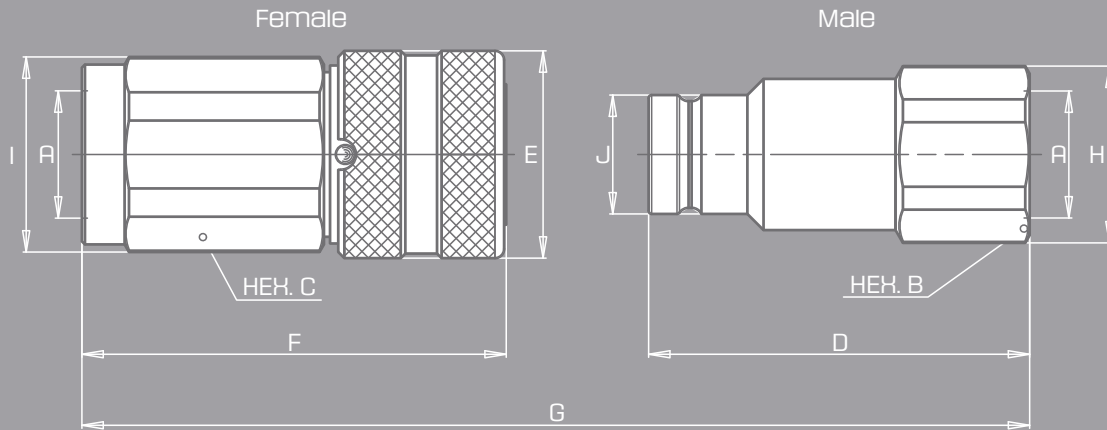

DESCRIPTION	BODY SIZE	A	UNIT	B	C	D	E	F	G	H	I	J	UNIT	WEIGHT	
														MALE	FEMALE
A4HP	1/8	1/8	mm	17.0	17.0	36.2	22.0	44.0	72.3	18.5	21.8	12.0	Kg	0.041	0.090
			inch	0.67	0.67	1.43	0.87	1.73	2.85	0.73	0.86	0.47	lb	0.09	0.20
A5HP	1/4	1/4	mm	22.0	22.0	47.9	29.0	58.0	94.9	23.8	29.0	16.5	Kg	0.090	0.205
			inch	0.87	0.87	1.89	1.14	2.28	3.74	0.94	1.14	0.65	lb	0.20	0.45
A5HP	1/4	3/8	mm	24.0	24.0	54.9	29.0	60.0	103.9	26.0	29.0	16.5	Kg	0.107	0.209
			inch	0.94	0.94	2.16	1.14	2.36	4.09	1.02	1.14	0.65	lb	0.24	0.46
A9HP	3/8	3/8	mm	27.0	30.0	60.0	34.0	64.6	108.8	29.0	32.0	19.5	Kg	0.153	0.322
			inch	1.06	1.18	2.36	1.34	2.54	4.28	1.14	1.26	0.77	lb	0.34	0.71
A9HP	3/8	1/2	mm	27.0	30.0	62.5	34.0	69.6	116.3	29.0	32.0	19.5	Kg	0.144	0.308
			inch	1.06	1.18	2.46	1.34	2.74	4.58	1.14	1.26	0.77	lb	0.32	0.68



COUPLER



NIPPLE

### A-HP Female NPT Thread\_ ISO 16028

PART	BODY SIZE	PORT SIZE	THREAD TYPE	ORDER CODE	PART DESCRIPTION
COUPLER	1/8	1/8	FEMALE NPT	801601014	F. A4 HP 1/8 NPT
NIPPLE	1/8	1/8	FEMALE NPT	801601015	M. A4 HP 1/8 NPT
COUPLER	1/4	1/4	FEMALE NPT	801601004	F. A5 HP 1/4 NPT
NIPPLE	1/4	1/4	FEMALE NPT	801601005	M. A5 HP 1/4 NPT
COUPLER	1/4	3/8	FEMALE NPT	801601008	F. A5 HP 3/8 NPT
NIPPLE	1/4	3/8	FEMALE NPT	801601009	M. A5 HP 3/8 NPT
COUPLER	3/8	3/8	FEMALE NPT	801601010	F. A9 HP 3/8 NPT
NIPPLE	3/8	3/8	FEMALE NPT	801601011	M. A9 HP 3/8 NPT
COUPLER	3/8	1/2	FEMALE NPT	801601012	F. A9 HP 1/2 NPT
NIPPLE	3/8	1/2	FEMALE NPT	801601013	M. A9 HP 1/2 NPT

# Connect Under Pressure Threaded Flat Face Coupling



## Flat Face: Threaded Coupling

**Series:** VEP

**Interchange:** None

- High working pressures: 40-60 MPa/5800-8700 psi range based on size
- Thread coupling system eliminates brinelling, premature leakage
- Connect/disconnect under residual pressure up to 25 MPa/3625 psi
- Valve limits fluid movement during connection avoiding damage to other elements of circuit
- Low connection force required

**Fire Tested and Lloyd's Certified\* in compliance with API 16D Test and EUB Directive 36.**

\* Lloyd's document available upon request

### Overview

Stucchi VEP series is the ultimate solution and most popular for hydraulic circuit applications subject to high pressure impulses, and circuits which experience high residual or trapped pressure in a line. The VEP thread-to-connect design eliminates premature wear or brinelling associated with locking ball designs subjected to high impulse pressures. The patented internal valve allows connection and disconnection with high residual pressures. Flat face design avoids loss of hydraulic fluid during connection/disconnection. Flat face design is easy to clean, limiting contamination into the circuit.

### Applications & Features

- Excavators w/auxiliary line for attachments: thumbs, grapples, hammers, and compactors/hopaks
- Oil Field, well head drives, porta-power
- Cranes, drilling machines, all large equipment needing junction points in circuit
- All construction equipment applications with higher pressure requirements or issues of connecting/disconnecting tool attachments under residual pressure
- Eliminates brinelling, reduces leakage
- Save time changing tools

# Connect Under Pressure Threaded Flat Face Coupling

DESCRIPTION	SIZE	MAX. OPERATING PRESSURE COUPLED		BURST PRESSURE						MAX. RESIDUAL PRESSURE DURING CONNECTION		SPILLAGE*
				COUPLED		MALE		FEMALE				
		MPa	psi	MPa	psi	MPa	psi	MPa	psi	MPa	psi	
VEP7	1/4	60	8700	150	21750	150	21750	126	18270	30	4350	0.012
VEP9P	3/8	55	7975	140	20300	140	20300	100	14500	25	3625	0.040
VEP13P	1/2	55	7975	140	20300	140	20300	100	14500	25	3625	0.025
VEP15P	3/4	55	7975	140	20300	140	20300	100	14500	25	3625	0.033
VEP17P	1	50	7250	125	18125	125	18125	100	14500	25	3625	0.018
VEP21P	1 1/4	47	6815	120	17400	120	17400	80	11600	25	3625	0.060
VEP30P	1 1/2	40	5800	110	15950	110	15950	80	11600	25	3625	0.200
VEP45P	2	35	5075	110	15950	110	15950	80	11600	25	3625	0.350

\* SPILLAGE IS AN INDICATIVE VALUE OF THE FLUID LOSS PER COUPLE-UNCUPLE CYCLE

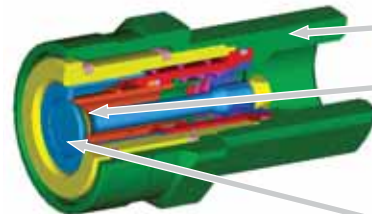
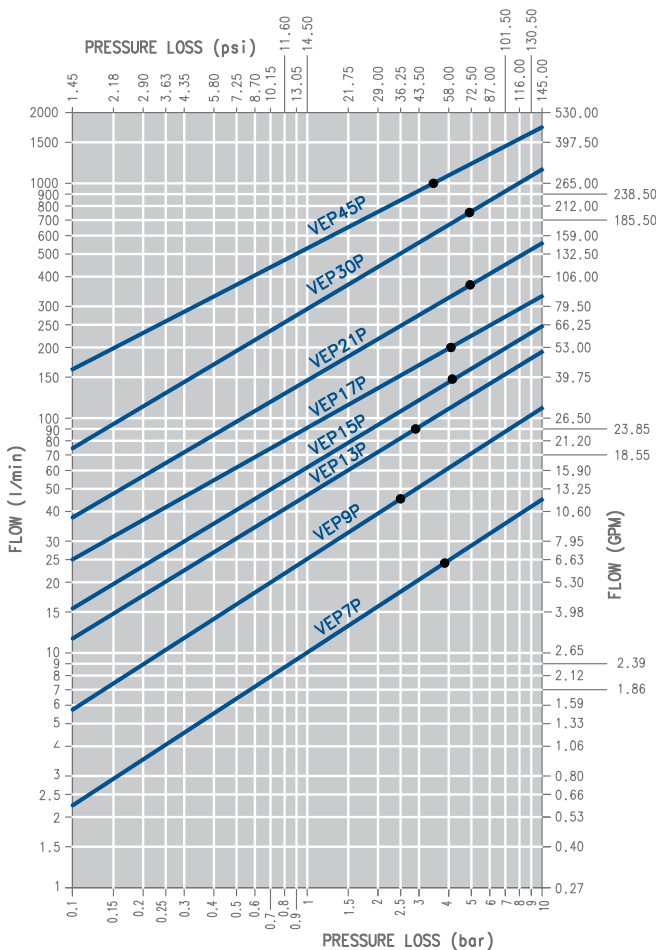

- Modular structure
- Special seal to prevent extrusion at high flow rates and during connection with residual pressure
- Flat face valves

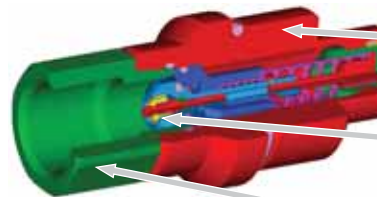

- Screw connection system eliminates premature wear
- Double valve system to release pressure
- Modular structure
- Flat face valves





## Flat Face: Connect Under Pressure Size Diagram

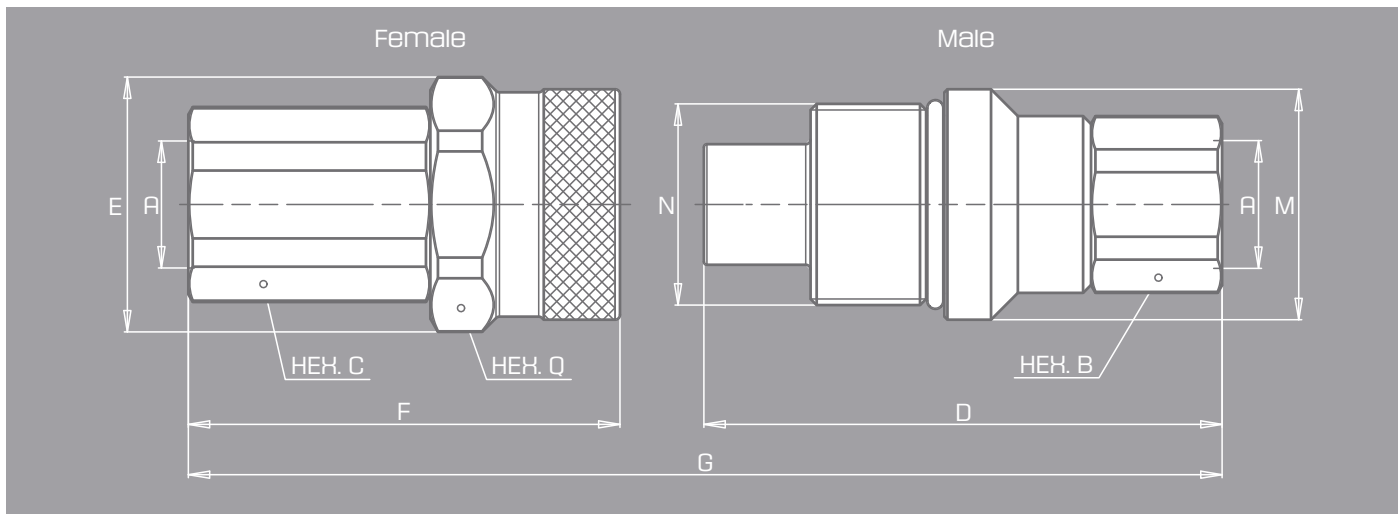

DESCRIPTION	BODY SIZE	A	UNIT	B	C	D	E	F	G	M	N	Q	UNIT	WEIGHT	
														MALE	FEMALE
VEP7	1/4	1/4	mm	22.0	27.0	71.0	38.8	54.1	113.3	34.8	M30X2	36.0	Kg	0.235	0.25
			inch	0.87	1.06	2.80	1.53	2.13	4.46	1.37		1.42	lb	0.52	0.55
VEP9P	3/8	3/8	mm	27.0	30.0	82.5	41.8	65.8	131.3	37.8	M33X2	38.0	Kg	0.325	0.335
			inch	1.06	1.18	3.25	1.65	2.59	5.17	1.49		1.50	lb	0.72	0.74
VEP9P	3/8	1/2	mm	27.0	30.0	85.0	41.8	70.8	138.8	37.8	M33X2	38.0	Kg	0.320	0.345
			inch	1.06	1.18	3.35	1.65	2.79	5.46	1.49		1.50	lb	0.71	0.76
VEP13P	1/2	1/2	mm	36.0	36.0	95.0	49.8	77.8	154.6	45.8	M40X3	46.0	Kg	0.605	0.635
			inch	1.42	1.42	3.74	1.96	3.06	6.09	1.80		1.81	lb	1.33	1.40
VEP13P	1/2	3/4	mm	36.0	36.0	97.4	49.8	84.8	164.0	45.8	M40X3	46.0	Kg	0.59	0.60
			inch	1.42	1.42	3.83	1.96	3.34	6.46	1.80		1.81	lb	1.30	1.32
VEP15P	3/4	3/4	mm	36.0	41.0	99.0	53.8	84.9	165.4	49.8	M45X3	50.0	Kg	0.69	0.765
			inch	1.42	1.61	3.90	2.12	3.34	6.51	1.96		1.97	lb	1.52	1.69
VEP17P	1	3/4	mm	46.0	46.0	113.6	58.8	96.7	187.5	54.8	M50X3	55.0	Kg	1.065	1.168
			inch	1.81	1.81	4.47	2.31	3.81	7.38	2.16		2.17	lb	2.35	2.57
VEP17P	1	1	mm	46.0	46.0	113.6	58.8	99.7	190.5	54.8	M50X3	55.0	Kg	1.025	1.115
			inch	1.81	1.81	4.47	2.31	3.93	7.50	2.16		2.17	lb	2.26	2.46
VEP21P	1 1/4	1	mm	55.0	55.0	123.4	69.8	105.8	205.2	64.5	M58X3	65.0	Kg	1.540	1.780
			inch	2.17	2.17	4.86	2.75	4.17	8.08	2.54		2.56	lb	3.40	3.92
VEP21P	1 1/4	1 1/4	mm	55.0	55.0	123.4	69.8	106.8	206.2	64.5	M58X3	65.0	Kg	1.465	1.700
			inch	2.17	2.17	4.86	2.75	4.20	8.12	2.54		2.56	lb	3.23	3.75
VEP30P	1 1/2	1 1/4	mm	65.0	65.0	150.0	92.0	133.5	253.9	89.8	M80X4	85.0	Kg	3.245	3.910
			inch	2.56	2.56	5.91	3.62	5.26	10.00	3.54		3.35	lb	7.15	8.62
VEP30P	1 1/2	1 1/2	mm	65.0	65.0	150.0	92.0	133.5	253.9	89.8	M80X4	85.0	Kg	3.18	3.84
			inch	2.56	2.56	5.91	3.62	5.26	10.00	3.54		3.35	lb	7.01	8.47
VEP45P	2	2	mm	90.0	90.0	218.4	200.0	224.8	383.5	145.0	M130X6	0.00	Kg	11.67	14.76
			inch	3.54	3.54	8.60	7.87	8.85	15.10	5.71		0.00	lb	25.73	32.54

# Connect Under Pressure Threaded Flat Face Coupling



COUPLER



NIPPLE

## VEP-NPT, Flange and SAE Thread\_Flat Face Thread Coupling with High Residual Pressure

PART	BODY SIZE	PORT SIZE	THREAD TYPE	ORDER CODE	PART DESCRIPTION
<b>VEP NPT THREAD</b>					
COUPLER	1/4	1/4	NPT	806501008	F. VEP7 1/4 NPT
NIPPLE	1/4	1/4	NPT	806501009	M. VEP7 1/4 NPT
COUPLER	3/8	3/8	NPT	806501002	F. VEP9 3/8 NPT
NIPPLE	3/8	3/8	NPT	806501003	M. VEP9 3/8 NPT
COUPLER	3/8	1/2	NPT	806501014	F. VEP9 1/2 NPT
NIPPLE	3/8	1/2	NPT	806501015	M. VEP9 1/2 NPT
COUPLER	1/2	1/2	NPT	806501000	F. VEP13 1/2 NPT
NIPPLE	1/2	1/2	NPT	806501001	M. VEP13 1/2 NPT
COUPLER	1/2	3/4	NPT	806501016	F. VEP13 3/4 NPT
NIPPLE	1/2	3/4	NPT	806501017	M. VEP13 3/4 NPT
COUPLER	3/4	3/4	NPT	806501004	F. VEP15 3/4 NPT
NIPPLE	3/4	3/4	NPT	806501005	M. VEP15 3/4 NPT
COUPLER	1	1	NPT	806501006	F. VEP17 1 NPT
NIPPLE	1	1	NPT	806501007	M. VEP17 1 NPT
COUPLER	1 1/4	1 1/4	NPT	806501010	F. VEP21 114 NPT
NIPPLE	1 1/4	1 1/4	NPT	806501011	M. VEP21 114 NPT
COUPLER	1 1/2	1 1/2	NPT	806501012	F. VEP30 112 NPT
NIPPLE	1 1/2	1 1/2	NPT	806501013	M. VEP30 112 NPT
COUPLER	2	2	NPT	807201018	F. VEP45 2 NPT
NIPPLE	2	2	NPT	807201019	M. VEP45 2 NPT
<b>VEP SAE THREAD</b>					
COUPLER	3/8	1/2	SAE	806504000	F. VEP 9 1/2 SAE
NIPPLE	3/8	1/2	SAE	806504001	M. VEP 9 1/2 SAE
COUPLER	1/2	3/4	SAE	806504004	F. VEP 13 3/4 SAE
NIPPLE	1/2	3/4	SAE	806504005	M. VEP 13 3/4 SAE
COUPLER	3/4	3/4	SAE	806504006	F. VEP 15 3/4 SAE
NIPPLE	3/4	3/4	SAE	806504007	M. VEP 15 3/4 SAE
COUPLER	1	1	SAE	806504002	F. VEP 17 1 SAE
NIPPLE	1	1	SAE	806504003	M. VEP 17 1 SAE
COUPLER	1 1/4	1 1/4	SAE	806504010	F. VEP21 114 SAE
NIPPLE	1 1/4	1 1/4	SAE	806504011	M. VEP21 114 SAE
COUPLER	1 1/2	1 1/2	SAE	806504012	F. VEP30 112 SAE
NIPPLE	1 1/2	1 1/2	SAE	806504013	M. VEP30 112 SAE
COUPLER	2	2	SAE	807204018	F. VEP45 2 SAE
NIPPLE	2	2	SAE	807204019	M. VEP45 2 SAE
<b>VEP FLANGE THREAD</b>					
COUPLER	2	2	FLANGE	807224020	F. VEP45 2 CODE 62 FP
NIPPLE	2	2	FLANGE	807224021	M. VEP45 2 CODE 62 FP



**VEP ORFS and BSP Thread**\_Flat Face Thread Coupling with High Residual Pressure

PART	BODY SIZE	PORT SIZE	THREAD TYPE	ORDER CODE	PART DESCRIPTION
<b>VEP ORFS THREAD</b>					
COUPLER	3/8	3/8	ORFS	807213002	F. VEP 9P 3/8 ORFS
NIPPLE	3/8	3/8	ORFS	807213003	M. VEP 9P 3/8 ORFS
COUPLER	1/2	1/2	ORFS	807213004	F. VEP 13P 1/2 ORFS
NIPPLE	1/2	1/2	ORFS	807213005	M. VEP 13P 1/2 ORFS
COUPLER	3/4	3/4	ORFS	807213006	F. VEP 15P 3/4 ORFS
NIPPLE	3/4	3/4	ORFS	807213007	M. VEP 15P 3/4 ORFS
COUPLER	1	1	ORFS	807213008	F. VEP 17P 1 ORFS
NIPPLE	1	1	ORFS	807213009	M. VEP 17P 1 ORFS
<b>VEP ORFS BH THREAD</b>					
COUPLER	3/8	3/8	ORFS BULKHEAD	807213016	F. VEP 9P 3/8 ORFS BH
NIPPLE	3/8	3/8	ORFS BULKHEAD	807213017	M. VEP 9P 3/8 ORFS BH
COUPLER	1/2	1/2	ORFS BULKHEAD	807213018	F. VEP 13P 1/2 ORFS BH
NIPPLE	1/2	1/2	ORFS BULKHEAD	807213019	M. VEP 13P 1/2 ORFS BH
COUPLER	3/4	3/4	ORFS BULKHEAD	807213020	F. VEP 15P 3/4 ORFS BH
NIPPLE	3/4	3/4	ORFS BULKHEAD	807213021	M. VEP 15P 3/4 ORFS BH
COUPLER	1	1	ORFS BULKHEAD	807213022	F. VEP 17P 1 ORFS BH
NIPPLE	1	1	ORFS BULKHEAD	807213023	M. VEP 17P 1 ORFS BH
<b>VEP BSP THREAD</b>					
COULER	3/8	3/8	BSP	807200002	F. VEP 9P 3/8 BSP
NIPPLE	3/8	3/8	BSP	807200003	M. VEP 9P 3/8 BSP
COULER	1/2	1/2	BSP	807200006	F. VEP 13P 1/2 BSP
NIPPLE	1/2	1/2	BSP	807200007	M. VEP 13P 1/2 BSP
COULER	3/4	3/4	BSP	807200010	F. VEP 15 3/4 BSP
NIPPLE	3/4	3/4	BSP	807200011	M. VEP 15P 3/4 BSP
COULER	1	1	BSP	807200012	F. VEP 17P 1 BSP
NIPPLE	1	1	BSP	807200013	M. VEP 17P 1 BSP
COULER	1 1/4	1	BSP	807200020	F. VEP 21P 1 BSP
NIPPLE	1 1/4	1	BSP	807200021	M. VEP 21P 1 BSP
COULER	1 1/4	1 1/4	BSP	807200014	F. VEP 21P 1 1/4 BSP
NIPPLE	1 1/4	1 1/4	BSP	807200015	M. VEP 21P 1 1/4 BSP
COULER	1 1/2	1 1/2	BSP	807200022	F. VEP 30P 1 1/2 BSP
NIPPLE	1 1/2	1 1/2	BSP	807200023	M. VEP 30P 1 1/2 BSP
COULER	2	2	BSP	807200018	F. VEP 45P 2 BSP
NIPPLE	2	2	BSP	807200019	M. VEP 45P 2 BSP



COUPLER



NIPPLE

# Connect Under Pressure Threaded Flat Face Coupling



## Flat Face: Threaded Coupling

**Series: VEP HD**

**Interchange: VEP**

- High working pressures: 40-55 MPa/5800-7250 psi range based on size
- Threaded coupling system eliminates brinelling, premature leakage
- Connect/disconnect under residual pressure up to 25 MPa/3625 psi
- Valve limits fluid movement during connection avoiding damage to other elements of circuit
- Low connection force required

**Fire Tested and Lloyd's Certified\* in compliance with API 16D Test and EUB Directive 36.**

\* Lloyd's document available upon request

### Overview

Stucchi VEP HD Series is the ultimate solution and most popular to hydraulic circuit applications subject to high pressure impulses, and circuits which experience high residual or trapped pressure in a line. The VEP HD thread-to-connect design eliminates premature wear or brinelling associated with locking ball designs subjected to high impulse pressures. New HD version has upgraded material, yellow o-ring visual ID, and larger mating areas. The patented internal valve allows connection and disconnection with high residual pressures. Flat face design avoids loss of hydraulic fluid during connection/disconnection. Flat face design is easy to clean, limiting contamination into the circuit.

### Application & Features

- Higher grade of steel for longer life, yellow o-ring visual ID, and larger mating areas
- Excavators w/auxiliary line for attachments: thumbs, grapples, hammers, and compactors/hopaks
- High impulse mobile circuits
- All construction equipment applications with higher pressure requirements or issues of connecting/disconnecting tool attachments under residual pressure
- Connect/disconnect up to 25 MPa/3625 psi residual pressure
- Save time changing tools



DESCRIPTION	PORT TYPE	SIZE	MAX. OPERATING PRESSURE COUPLED		BURST PRESSURE						MAX. RESIDUAL PRESSURE DURING CONNECTION		SPILLAGE*
					COUPLED		MALE		FEMALE				
			MPa	psi	MPa	psi	MPa	psi	MPa	psi	MPa	psi	MPa
<b>VEP HD FLANGE PORT</b>													
VEP17HD	FLANGE	1	42	6091	165	24000	165	24000	100	14500	25	3625	0.018
VEP21HD	FLANGE	1 1/4	42	6091	165	24000	165	24000	80	11600	25	3625	0.060
VEP30HD	FLANGE	1 1/2	42	6091	165	24000	165	24000	80	11600	25	3625	0.200
<b>VEP HD</b>													
VEP15HD		3/4	55	7975	140	20300	140	20300	100	14500	25	3625	0.033
VEP17HD		1	50	7250	125	18125	125	18125	100	14500	25	3625	0.018
VEP21HD		1 1/4	47	6815	120	17400	120	17400	80	11600	25	3625	0.060
VEP30HD		1 1/2	40	5800	110	15950	110	15950	80	11600	25	3625	0.200

\* SPILLAGE IS AN INDICATIVE VALUE OF THE FLUID LOSS PER COUPLE-UNCUPLE CYCLE

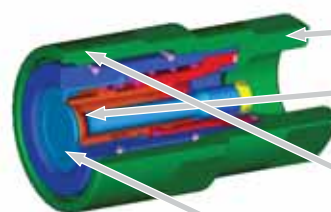
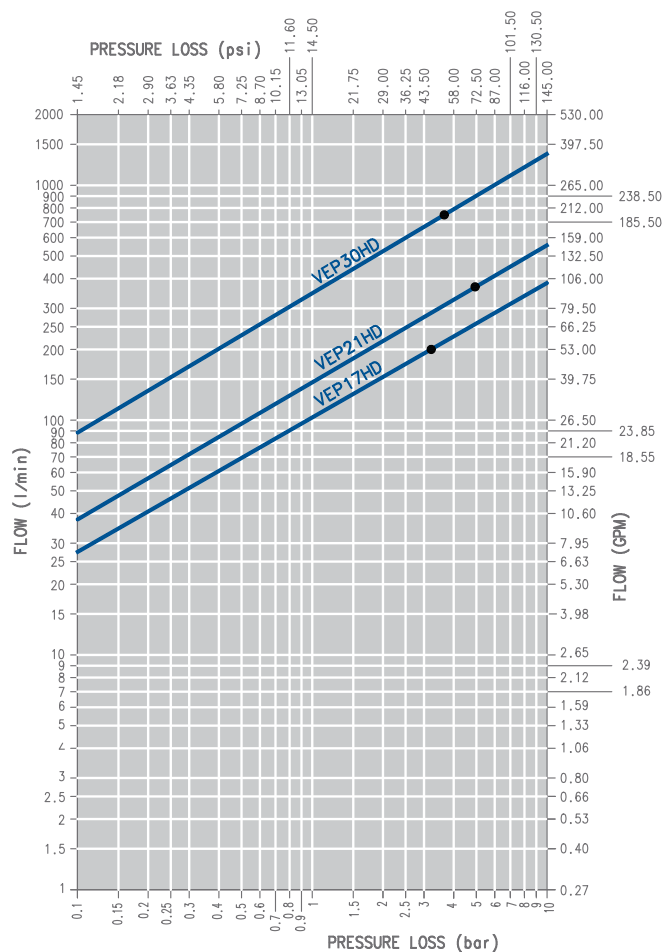

- Modular structure
- Special seal to prevent extrusion at high flow rates and during connection with residual pressure
- Strong structure of connection sleeve
- Flat face valves

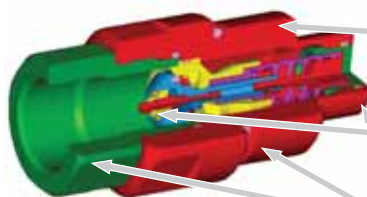

- Screw connection system eliminates premature wear
- Double valve system to release pressure
- Modular structure
- Strong structure of male body
- Flat face valves

# Connect Under Pressure Threaded Flat Face Coupling

## VEP HD: Connect Under Pressure

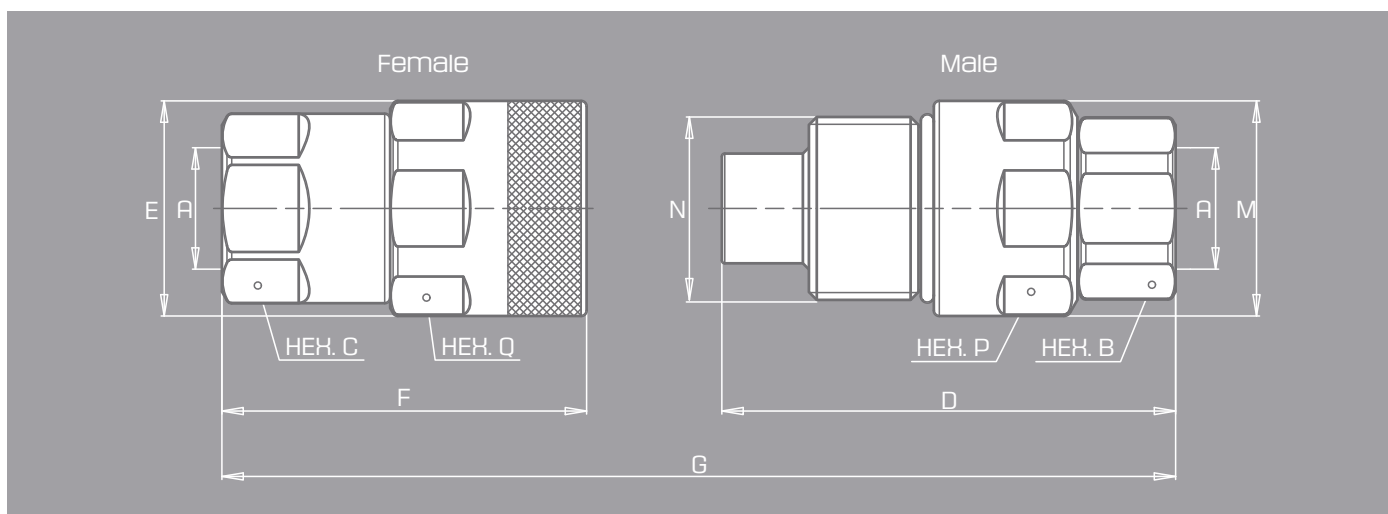

DESCRIPTION	BODY SIZE	A	UNIT	B	C	D	E	F	G	M	N	P	Q	UNIT	WEIGHT	
															MALE	FEMALE
VEP17HD	1	3/4	mm	46	46	124	58.8	99.7	200.9	58.8	M50x3	55	55	Kg	1.350	1.330
			inch	1.81	1.81	4.88	2.31	3.93	7.91	2.31		2.17	2.17	lb	2.98	2.93
VEP17HD	1	1	mm	46	46	12	58.8	99.7	200.9	58.8	M50x3	55	55	Kg	1.300	1.280
			inch	1.81	1.81	4.88	2.31	3.93	7.91	2.31		2.17	2.17	lb	2.87	2.82
VEP21HD	1 1/4	1	mm	55	55	133.4	69.8	106.8	216.2	69.8	M58x3	65	65	Kg	1.890	2.120
			inch	2.17	2.17	5.25	2.75	4.20	8.51	2.75		2.56	2.56	lb	4.17	4.67
VEP21HD	1 1/4	1 1/4	mm	55	55	133.4	69.8	106.8	216.2	69.8	M58x3	65	65	Kg	1.790	2.020
			inch	2.17	2.17	5.25	2.75	4.20	8.51	2.75		2.56	2.56	lb	3.95	4.45
VEP30HD	1 1/2	1 1/4	mm	65	65	150	95	133.5	253.9	94.4	M80x4	75	85	Kg	3.400	4.460
			inch	2.56	2.56	5.91	3.74	5.26	10.0	3.72		2.95	3.35	lb	7.50	9.83
VEP30HD	1 1/2	1 1/2	mm	65	65	150	95	133.5	253.9	94.4	M80x4	75	85	Kg	3.300	4.360
			inch	2.56	2.56	5.91	3.74	5.26	10.0	3.72		2.95	3.35	lb	7.28	9.61





# VEP HD Flange Pad: Connect Under Pressure

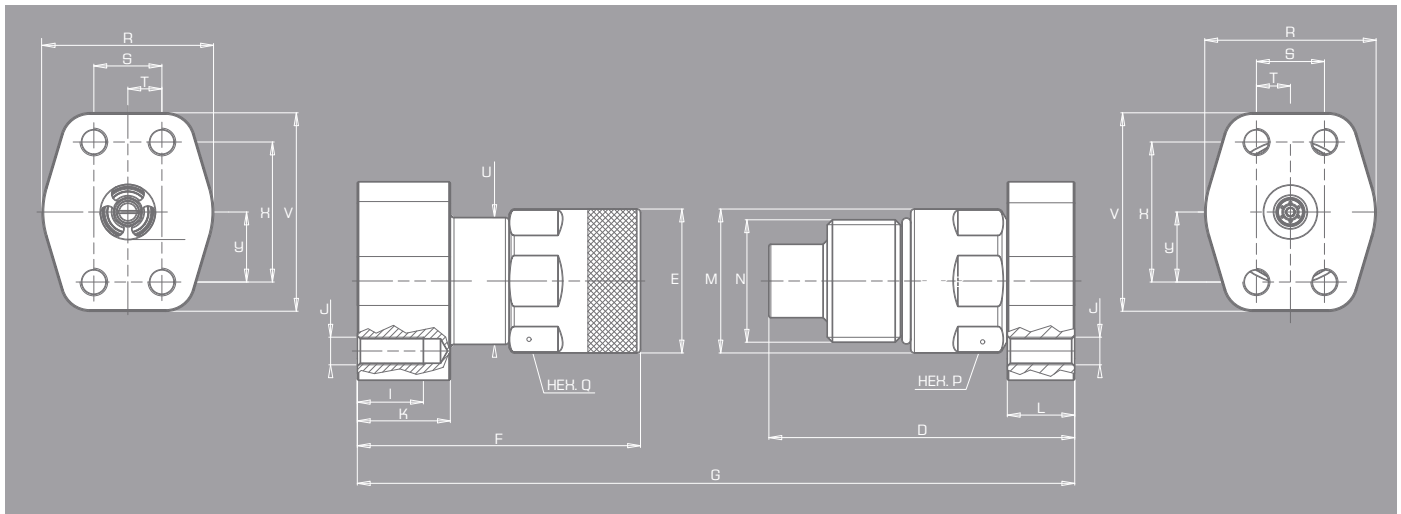

DESCRIPTION	UNIT	D	E	F	G	I	J	K	L	M	N	P
VEP17HD 1 FPU CODE 62	mm	125	58.8	115.7	217.9	27	UNC 7/16 - 14	38	27.55	58.8	M50X3	55
	inch	4.92	2.31	4.56	8.58	1.06		1.5	1.08	2.31		2.16
VEP21HD 1 FPM CODE 62	mm	135.2	69.8	116.8	228	27	M12	38	38	69.8	M58X3	65
	inch	5.32	2.75	4.6	8.98	1.06		1.5	1.5	2.75		2.56
VEP21HD 1 1/4 FPU CODE 62	mm	123.2	69.8	115.8	215	25	UNC 1/2 - 13	37	26	69.8	M58X3	65
	inch	4.85	2.75	4.57	8.46	0.98		1.46	1.02	2.75		2.56
VEP30HD 1 1/4 FPU CODE 62	mm	147.6	95	148.5	266.5	27	UNC 1/2 - 13 2B	37.9	35	94.4	80X4 TPF	75
	inch	5.81	3.74	5.85	10.49	1.06		1.49	1.38	3.72		2.95
VEP30HD 1 1/4 FPM CODE 62	mm	147.6	95	148.5	266.5	25	M14	37.9	35	94.4	80X4 TPF	75
	inch	5.81	3.74	5.85	10.49	0.98		1.49	1.38	3.72		2.95
VEP30HD 1 1/2 FPU CODE 62	mm	149.6	95	156.6	276.6	35	UNC 5/8 - 11	46	37	94.4	80X4 TPF	75
	inch	5.89	3.74	6.16	10.89	1.38		1.81	1.46	3.72		2.95

DESCRIPTION	UNIT	Q	R	S	T	U	V	W	X	Y	Z	UNIT	WEIGHT	
													MALE	FEMALE
VEPL7HD 1 FPU CODE62	mm	55	70	27.8	13.9	51.8	81.05	22.5	57.2	28.6	22	Kg	1.96	2.34
	inch	2.16	2.76	1.09	0.55	2.04	3.19	0.89	2.25	1.13	0.87	lb	4.31	5.15
VEP2LHD 1 FPM CODE 62	mm	65	70	27.8	13.9	68	81.05	22.5	57.2	28.6	22.5	Kg	2.23	2.82
	inch	2.56	2.76	1.09	0.55	2.68	3.19	0.89	2.25	1.13	0.89	lb	4.91	6.2
VEP2LHD 1 1/4 FPU CODE 62	mm	65	78	31.8	15.9	68	95.25	25.6	66.6	33.3	25.6	Kg	2.45	3.29
	inch	2.56	3.07	1.25	0.63	2.68	3.75	1.01	2.62	1.3L	1.01	lb	5.39	7.24
VEP30HD 1 1/4 FPU CODE 62	mm	85	78	31.8	15.9	89	95.25	32	66.6	33.3	32	Kg	4.01	5.68
	inch	3.35	3.07	1.25	0.63	3.5	3.75	1.26	2.62	1.31	1.26	lb	8.82	12.5
VEP30HD 1 1/4 FPM CODE 62	mm	85	78	31.8	15.9	89	95.25	32	66.6	33.3	32	Kg	4.01	5.68
	inch	3.35	3.07	1.25	0.63	3.5	3.75	1.26	2.62	1.31	1.26	lb	8.82	12.5
VEP30HD 1 1/2 FPU CODE 62	mm	85	95	36.5	18.25	89	112.8	35	79.3	39.65	32	Kg	4.81	6.91
	inch	3.35	3.74	1.44	0.72	3.5	4.44	1.38	3.12	1.56	1.26	lb	10.58	15.2

# Connect Under Pressure Threaded Flat Face Coupling

## VEP HD Flange Head: Connect Under Pressure

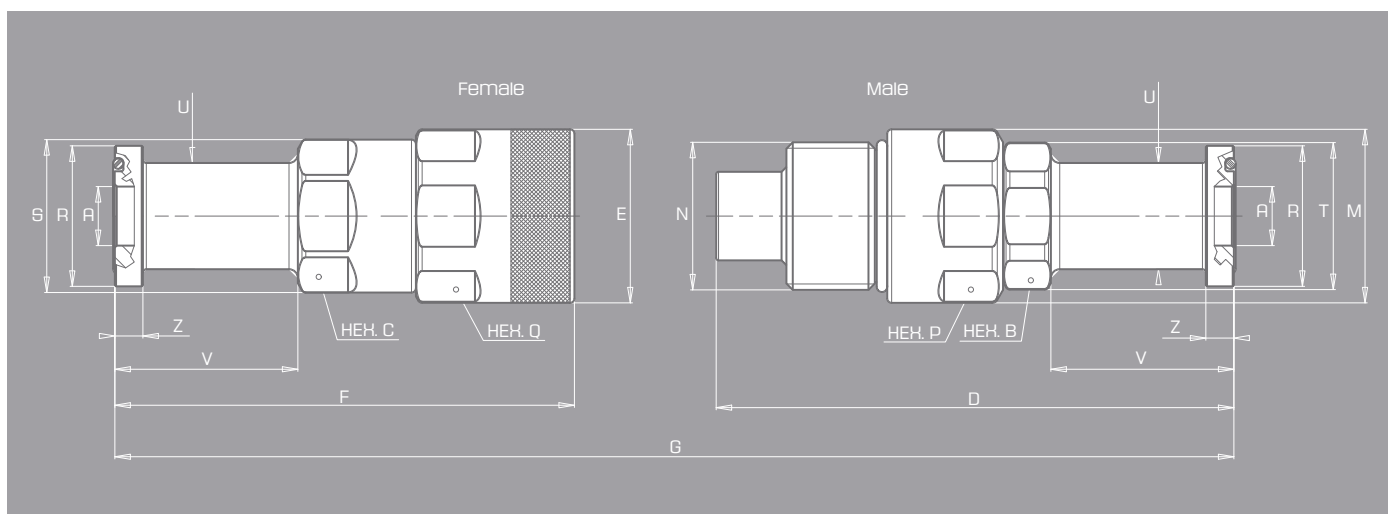

DESCRIPTION	A	UNIT	B	C	D	E	F	G	M	N	P
VEP17HD 1 FH CODE 62	20	mm	46	46	175.4	58.8	155.7	308.3	58.8	M50X3	55
	0.79	inch	1.81	1.81	6.9	2.31	6.13	12.14	2.31		2.16
VEP21HD 1 1/4 FH CODE 62	25.6	mm	55	55	184.2	69.8	170.8	331	69.8	M58X3	65
	1.01	inch	2.16	2.16	7.25	2.75	6.72	13.03	2.75		2.56
VEP30HD 1 1/4 FH CODE 62	28	mm	65	65	201.6	95	199.5	371.5	94.4	80X4 TPF	75
	1.1	inch	2.56	2.56	7.94	3.74	7.85	14.63	3.72		2.95
VEP30HD 1 1/2 FH CODE 62	32	mm	65	65	211.6	95	209.5	391.5	94.4	80X4 TPF	75
	1.26	inch	2.56	2.56	8.33	3.74	8.25	15.41	3.72		2.95

DESCRIPTION	UNIT	Q	R	S	T	U	V	Z	UNIT	WEIGHT	
										MALE	FEMALE
VEP17HD 1 FH CODE 62	mm	55	47.6	51.8	49.8	36	62	9.5	Kg	1.65	1.68
	inch	2.16	1.87	2.04	1.96	1.42	2.44	0.37	lb	3.63	3.7
VEP21HD 1 1/4 FH CODE 62	mm	65	53.9	68	59.8	41.9	69	10.3	Kg	2.16	2.6
	inch	2.56	2.12	2.68	2.35	1.65	2.72	0.41	lb	4.75	5.72
VEP30HD 1 1/4 FH CODE 62	mm	85	53.9	89	69.8	44	69	10.3	Kg	3.61	5.01
	inch	3.35	2.12	3.5	2.75	1.73	2.72	0.41	lb	7.94	11.02
VEP30HD 1 1/2 FH CODE 62	mm	85	63.5	89	69.8	49	79	12.6	Kg	3.85	5.23
	inch	3.35	2.5	3.5	2.75	1.93	3.11	0.5	lb	8.47	11.51



### VEP-HD NPT and SAE Thread\_Flat Face Thread Coupling with High Residual Pressure

PART	BODY SIZE	PORT SIZE	THREAD TYPE	ORDER CODE	PART DESCRIPTION
<b>VEP-HD NPT THREAD</b>					
COUPLER	3/4	3/4	NPT	808101010	F. VEP 15HD 3/4 NPT
NIPPLE	3/4	3/4	NPT	808101011	M. VEP 15HD 3/4 NPT
COUPLER	1	1	NPT	808101012	F. VEP17HD 1 NPT
NIPPLE	1	1	NPT	808101013	M. VEP17HD 1 NPT
COUPLER	1 1/4	1 1/4	NPT	808101014	F. VEP21HD 114 NPT
NIPPLE	1 1/4	1 1/4	NPT	808101015	M. VEP21HD 114 NPT
COUPLER	1 1/2	1 1/2	NPT	808101016	F. VEP30HD 112 NPT
NIPPLE	1 1/2	1 1/2	NPT	808101017	M. VEP30HD 112 NPT
<b>VEP-HD SAE THREAD</b>					
COUPLER	3/4	3/4	SAE	808104010	F. VEP 15HD 3/4 SAE
NIPPLE	3/4	3/4	SAE	808104011	M. VEP 15HD 3/4 SAE
COUPLER	1	1	SAE	808104012	F. VEP17HD 1 SAE
NIPPLE	1	1	SAE	808104013	M. VEP17HD 1 SAE
COUPLER	1 1/4	1 1/4	SAE	808104014	F. VEP21HD 114 SAE
NIPPLE	1 1/4	1 1/4	SAE	808104015	M. VEP21HD 114 SAE
COUPLER	1 1/2	1 1/2	SAE	808104016	F. VEP30HD 112 SAE
NIPPLE	1 1/2	1 1/2	SAE	808104017	M. VEP30HD 112 SAE



COUPLER



NIPPLE

### VEP-HD Flange Ports\_Flat Face Thread Coupling with High Residual Pressure

PART	BODY SIZE	PORT SIZE	THREAD TYPE	ORDER CODE	PART DESCRIPTION
<b>VEP-HD FLANGE PORTS</b>					
COUPLER	1	1	FLANGE HEAD	808124012	F. VEP17 HD 1FH CODE 62
NIPPLE	1	1	FLANGE HEAD	808124013	M. VEP17 HD 1FH CODE 62
COUPLER	1	1	FLANGE PAD	808124020	F. VEP17 HD 1 FPU CODE 62
NIPPLE	1	1	FLANGE PAD	808124021	M. VEP17 HD 1 FPU CODE 62
COUPLER	1 1/4	1 1/4	FLANGE HEAD	808124014	F. VEP21 HD 1 1/4 FH CODE 62
NIPPLE	1 1/4	1 1/4	FLANGE HEAD	808124015	M. VEP21 HD 1 1/4 FH CODE 62
COUPLER	1 1/4	1 1/4	FLANGE PAD	808124022	F. VEP21 HD 1 1/4 FPU CODE 62
NIPPLE	1 1/4	1 1/4	FLANGE PAD	808124023	M. VEP21 HD 1 1/4 FPU CODE 62
COUPLER	1 1/2	1 1/2	FLANGE HEAD	808124016	F. VEP30HD 1 1/2 FH CODE 62
NIPPLE	1 1/2	1 1/2	FLANGE HEAD	808124017	M. VEP30HD 1 1/2 FH CODE 62
COUPLER	1 1/2	1 1/2	FLANGE PAD	808124024	F. VEP30HD 1 1/2 F PU CODE 62
NIPPLE	1 1/2	1 1/2	FLANGE PAD	808124025	M. VEP30HD 1 1/2 FPU CODE 62
COUPLER	1 1/2	1 1/4	FLANGE HEAD	808124038	F. VEP30HD 1 1/4 FH CODE 62
NIPPLE	1 1/2	1 1/4	FLANGE HEAD	808124039	M. VEP30HD 1 1/4 FH CODE 62
COUPLER	1 1/2	1 1/2	FLANGE PAD	808124034	F. VEP 30HD 1 1/2 FPM CODE 62 M12
NIPPLE	1 1/2	1 1/2	FLANGE PAD	808124035	M. VEP 30HD 1 1/2 FPM CODE 62 M12
COUPLER	1 1/2	1 1/2	FLANGE PAD	808124040	F. VEP 30HD 1 1/2 FPM CODE 62 M14
NIPPLE	1 1/2	1 1/2	FLANGE PAD	808124041	M. VEP 30HD 1 1/2 FPM CODE 62 M14



FLANGE HEAD



FLANGE PAD

2 BOLT THREAD OPTIONS FOR FLANGE PAD PORTS: UNF AND METRIC.  
FOR SIZE 1 1/4 PAD METRIC OPTIONS ARE M12 & M14.

# Connect Under Pressure Threaded Flat Face Coupling



## Flat Face: Threaded Coupling

**Series:** VP

**Interchange:** None

- Connect/disconnect with residual pressure up to 25 MPa/3625 psi
- Thread coupling system eliminates brinelling, premature leakage
- High working pressures: up to 40-60 MPa/5800-8700 psi
- Valve limits fluid movement during connection avoiding damage to other elements of circuit
- Low connection force required
- Safety auto-lock feature upon connecting

**Fire Tested and Lloyd's Certified\* in compliance with API 16D Test and EUB Directive 36.**

\*Lloyd's document available upon request

### Overview

Stucchi VP series is the ultimate solution and most popular for hydraulic circuit applications subject to high pressure impulses, and circuits which experience high residual or trapped pressure in a line. The VP thread-to-connect design eliminates premature wear or brinelling associated with locking ball designs subjected to high impulse pressures. The patented internal valve allows connection and disconnection with high residual pressures. Flat face design avoids loss of hydraulic fluid during connection/disconnection. Flat face design is easy to clean, limiting contamination into the circuit.

### Applications & Features

- Excavators w/auxiliary line for attachments: thumbs, grapples, hammers
- Oil Field, well head drives, porta-power
- Cranes, drilling machines, all large equipment needing junction points in circuit
- All construction equipment applications with higher pressure requirements or issues of connecting/disconnecting tool attachments under residual pressure
- Connect/disconnect up to 25MPa/3625 psi residual pressure
- Save time changing tools



DESCRIPTION	SIZE	MAX. OPERATING PRESSURE COUPLED		BURST PRESSURE						MAX. RESIDUAL PRESSURE DURING CONNECTION		SPILLAGE*
				COUPLED		MALE		FEMALE				
		MPa	psi	MPa	psi	MPa	psi	MPa	psi	MPa	psi	
VP7	1/4	60	8700	150	21750	150	21750	126	18270	30	4350	0.012
VP9P	3/8	55	7975	140	20300	140	20300	100	14500	25	3625	0.040
VP13P	1/2	55	7975	140	20300	140	20300	100	14500	25	3625	0.025
VP15P	3/4	55	7975	140	20300	140	20300	100	14500	25	3625	0.033
VP17P	1	50	7250	125	18125	125	18125	100	14500	25	3625	0.018
VP21P	1 1/4	47	6815	120	17400	120	17400	80	11600	25	3625	0.060
VP30P	1 1/2	40	5800	110	15950	110	15950	80	11600	25	3625	0.200

\* SPILLAGE IS AN INDICATIVE VALUE OF THE FLUID LOSS PER COUPLE-UNCUPLE CYCLE

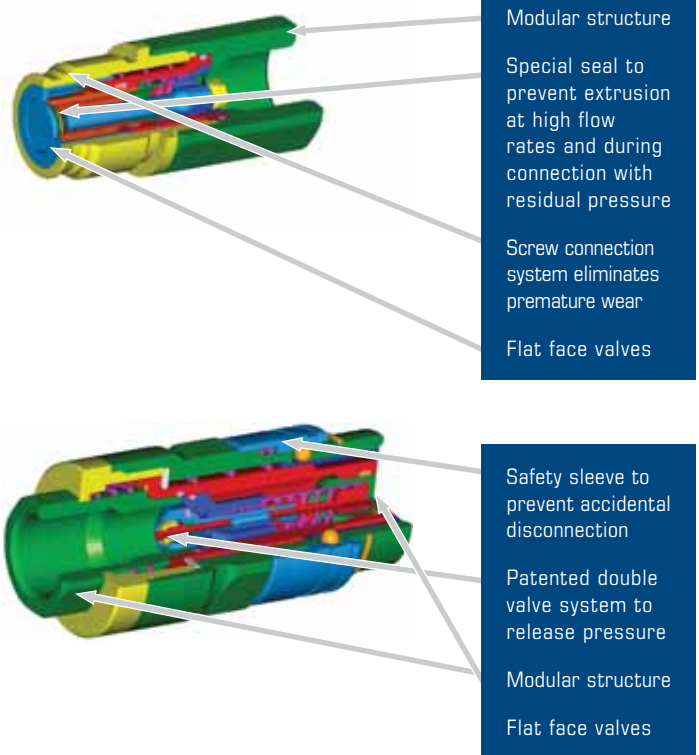
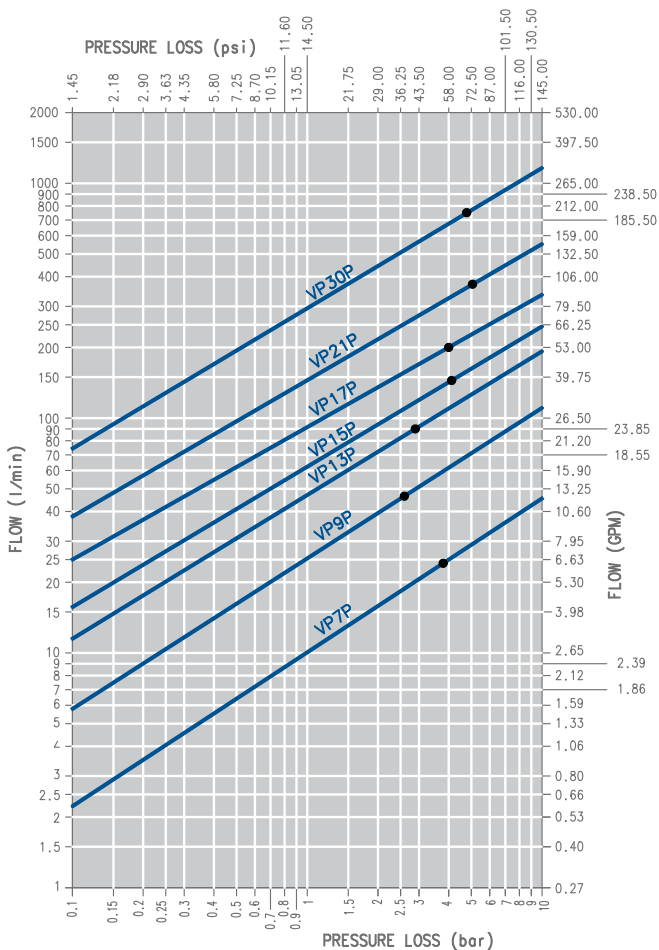

# Connect Under Pressure Threaded Flat Face Coupling

## Flat Face: Threaded Connect Under Pressure

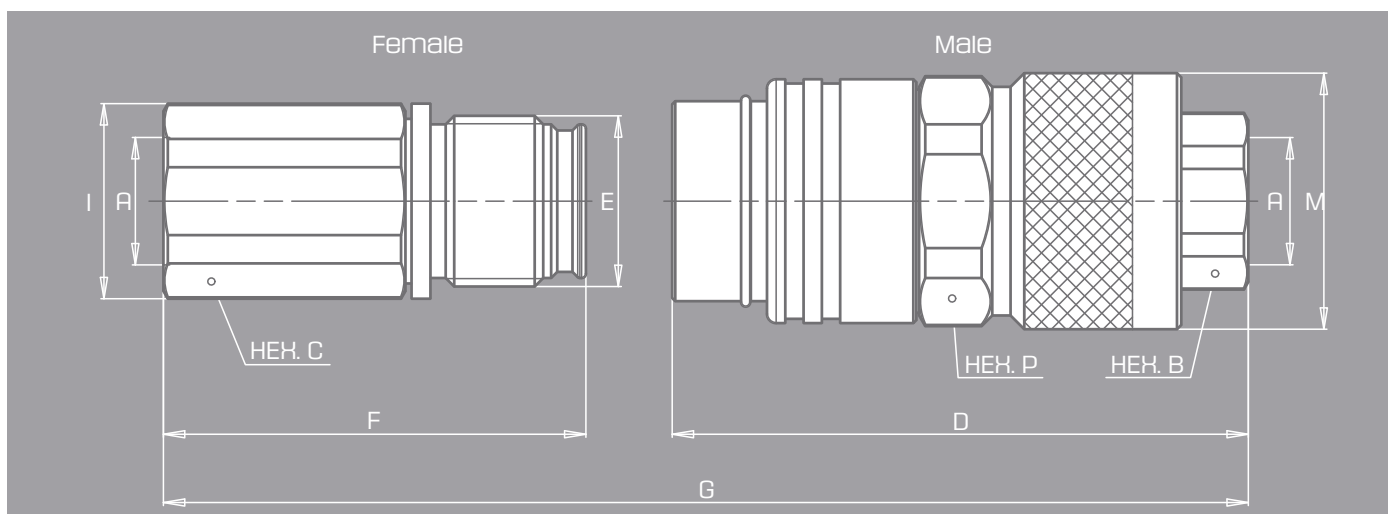

DESCRIPTION	BODY SIZE	A	UNIT	B	C	D	E	F	G	I	M	P	UNIT	WEIGHT	
														MALE	FEMALE
VP7	1/4	1/4	mm	22.0	27.0	85.3	M24X2	52.8	126.6	29.0	35.0	32.0	Kg	0.395	0.165
			inch	0.87	1.06	3.36		2.08	4.98	1.14	1.38	1.26		lb	0.87
VP9P	3/8	3/8	mm	27.0	30.0	94.5	M28X2	64.3	142.3	32.0	42.0	38.0	Kg	0.595	0.240
			inch	1.06	1.18	3.72		2.53	5.60	1.26	1.65	1.50		lb	1.31
VP9P	3/8	1/2	mm	27.0	30.0	94.5	M28X2	69.3	147.3	32.0	42.0	38.0	Kg	0.575	0.245
			inch	1.06	1.18	3.72		2.73	5.80	1.26	1.65	1.50		lb	1.27
VP13P	1/2	1/2	mm	36.0	36.0	110.0	M36X3	76.2	167.9	40.0	49.0	45.0	Kg	0.980	0.425
			inch	1.42	1.42	4.33		3.00	6.61	1.57	1.93	1.77		lb	2.16
VP13P	1/2	3/4	mm	36.0	36.0	110.0	M36X3	83.2	174.9	40.0	49.0	45.0	Kg	0.945	0.440
			inch	1.42	1.42	4.33		3.28	6.89	1.57	1.93	1.77		lb	2.08
VP15P	3/4	3/4	mm	36.0	41.0	110.0	M39X3	83.4	174.9	44.8	52.0	48.0	Kg	1.065	0.595
			inch	1.42	1.61	4.33		3.28	6.89	1.76	2.05	1.89		lb	2.35
VP17P	1	3/4	mm	46.0	46.0	127.1	M45X3	95.0	199.5	49.8	60.0	55.0	Kg	1.635	0.955
			inch	1.81	1.81	5.00		3.74	7.85	1.96	2.36	2.17		lb	3.60
VP17P	1	1	mm	46.0	46.0	127.1	M45X3	98.0	202.5	49.8	60.0	55.0	Kg	1.600	0.915
			inch	1.81	1.81	5.00		3.86	7.97	1.96	2.36	2.17		lb	3.53
VP21P	1 1/4	1	mm	55.0	55.0	137.0	M55X3	104.0	213.8	59.8	76.0	70.0	Kg	2.610	1.495
			inch	2.17	2.17	5.39		4.09	8.42	2.35	2.99	2.76		lb	5.75
VP21P	1 1/4	1 1/4	mm	55.0	55.0	137.0	M55X3	108.3	218.1	59.8	76.0	70.0	Kg	2.530	1.430
			inch	2.17	2.17	5.39		4.26	8.59	2.35	2.99	2.76		lb	5.58
VP30P	1 1/2	1 1/4	mm	65.0	65.0	174.7	M72X4	132.2	271.3	85.0	94.0	85.0	Kg	5.220	3.030
			inch	2.56	2.56	6.88		5.20	10.68	3.35	3.70	3.35		lb	11.51
VP30P	1 1/2	1 1/2	mm	65.0	65.0	174.7	M72X4	132.2	271.3	85.0	94.0	85.0	Kg	5.100	2.930
			inch	2.56	2.56	6.88		5.20	10.68	3.35	3.70	3.35		lb	11.24





**VP NPT and SAE Thread**\_Flat Face Thread Coupling with High Residual Pressure | Auto Lock

PART	BODY SIZE	PORT SIZE	THREAD TYPE	ORDER CODE	PART DESCRIPTION
<b>VP NPT THREAD</b>					
COUPLER	1/4	1/4	NPT	801901004	F. VP 7P 1/4 NPT
NIPPLE	1/4	1/4	NPT	801901005	M. VP 7P 1/4 NPT
COUPLER	3/8	3/8	NPT	801901010	F. VP 9P 3/8 NPT
NIPPLE	3/8	3/8	NPT	801901011	M. VP 9P 3/8 NPT
COUPLER	3/8	1/2	NPT	801901000	F. VP 9P 1/2 NPT
NIPPLE	3/8	1/2	NPT	801901001	M. VP 9P 1/2 NPT
COUPLER	1/2	1/2	NPT	801901006	F. VP 13P 1/2 NPT
NIPPLE	1/2	1/2	NPT	801901007	M. VP 13P 1/2 NPT
COUPLER	1/2	3/4	NPT	801901008	F. VP 13P 3/4 NPT
NIPPLE	1/2	3/4	NPT	801901009	M. VP 13P 3/4 NPT
COUPLER	3/4	3/4	NPT	801901002	F. VP 15P 3/4 NPT
NIPPLE	3/4	3/4	NPT	801901003	M. VP 15P 3/4 NPT
COUPLER	1	1	NPT	801901012	F. VP 17P 1 NPT
NIPPLE	1	1	NPT	801901013	M. VP 17P 1 NPT
COUPLER	1 1/4	1 1/4	NPT	801901014	F. VP 21P 114 NPT
NIPPLE	1 1/4	1 1/4	NPT	801901015	M. VP 21P 114 NPT
COUPLER	1 1/2	1 1/2	NPT	801901016	F. VP 30P 112 NPT
NIPPLE	1 1/2	1 1/2	NPT	801901017	M. VP 30P 112 NPT
<b>VP SAE THREAD</b>					
COUPLER	3/8	3/8	SAE	807304020	F. VP 9P 3/8 SAE
NIPPLE	3/8	3/8	SAE	807304021	M. VP 9P 3/8 SAE
COUPLER	1/2	1/2	SAE	807304022	F. VP 13P 1/2 SAE
NIPPLE	1/2	1/2	SAE	807304023	M. VP 13P 1/2 SAE
COUPLER	1/2	3/4	SAE	807304008	F. VP 13P 3/4 SAE
NIPPLE	1/2	3/4	SAE	807304009	M. VP 13P 3/4 SAE
COUPLER	3/4	3/4	SAE	807304010	F. VP 15P 3/4 SAE
NIPPLE	3/4	3/4	SAE	807304011	M. VP 15P 3/4 SAE
COUPLER	1	1	SAE	807304012	F. VP 17P 1 SAE
NIPPLE	1	1	SAE	807304013	M. VP 17P 1 SAE
COUPLER	1 1/4	1 1/4	SAE	807304014	F. VP 21P 114 SAE
NIPPLE	1 1/4	1 1/4	SAE	807304015	M. VP 21P 114 SAE
COUPLER	1 1/2	1 1/2	SAE	807304016	F. VP 30P 112 SAE
NIPPLE	1 1/2	1 1/2	SAE	807304017	M. VP 30P 112 SAE



COUPLER



NIPPLE

# ISO A Interchange Coupling



## Poppet: Interchange Coupling

### Series: BIR

**Interchange:** ISO A

BIR quick couplings are interchangeable according to the ISO 7241-1 series "A". They are available from size 1/4 to 2 inches in size, to cover the various fields of hydraulic applications. The series BIR couplings are the most used, from industrial plants to agriculture.

- Positive-stop valving prevents flow checking
- Large diameter sleeves resist deformation
- Steel sleeves hardened for maximum life
- Suitable for open center or closed center hydraulic system

### Overview

ISO A style couplings are one of the most popular designs worldwide used in agricultural, mobile equipment, and some industrial applications. The ISO A style is a durable product using a poppet style valve for the sealing mechanism. The Stucchi breadth of product exceeds that of most competitors by offering sizes over 1 inch.

### Technical Characteristics:

- Coupling Body: zinc plated steel
- Nipple is zinc-plated hardened steel
- Seals: Nitrile
- Anti-extrusion rings are Teflon
- NPT standard threads
- On request BSP threads & various seals
- Anti-dust plastic caps
- Clip provided auto shut nylon caps for BIR12 female coupler part available





DESCRIPTION	SIZE	ISO SIZE	MAX. OPERATING PRESSURE COUPLED		BURST PRESSURE						SPILLAGE*
					COUPLED		MALE		FEMALE		
			MPa	psi	MPa	psi	MPa	psi	MPa	psi	
BIR14	1/4	6.3	35	5075	126	18270	126	18270	126	18270	0.70
BIR38	3/8	10.0	30	4350	100	14500	100	14500	100	14500	1.20
BIR12	1/2	12.5	25	3625	80	11600	80	11600	100	14500	2.10
BIR34	3/4	20.0	25	3625	100	14500	100	14500	100	14500	5.20
BIR100	1	25.0	23	3335	80	11600	80	11600	80	11600	9.00
BIR114	1 1/4	31.5	23	3335	80	11600	80	11600	80	11600	27.00
BIR112	1 1/2	40	18	2610	64	9280	64	9280	64	9280	49.00
BIR200	2	50	13	1885	40	5800	40	5800	40	5800	75.00

\* SPILLAGE IS AN INDICATIVE VALUE OF THE FLUID LOSS PER COUPLE-UNCOUPLE CYCLE

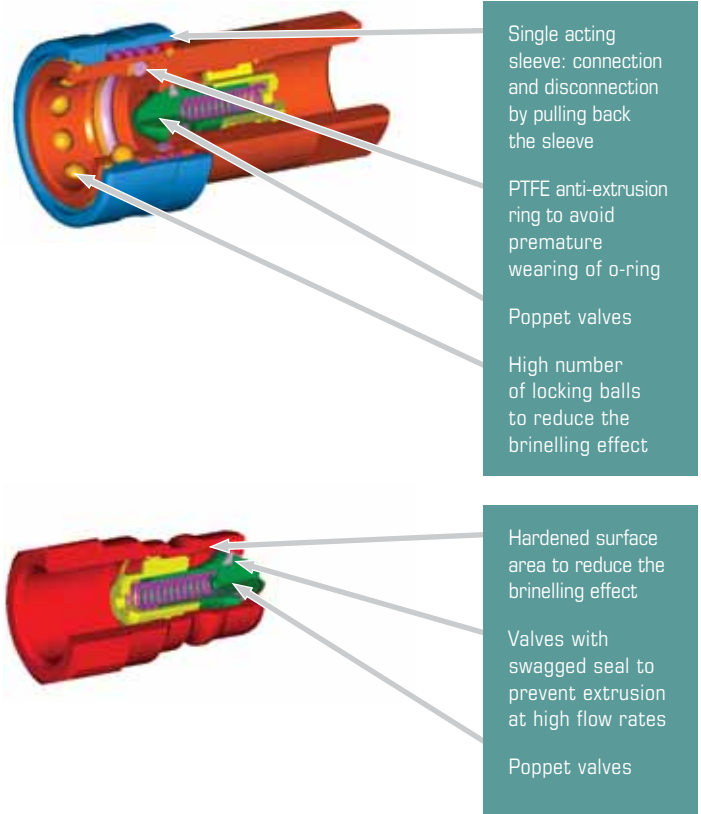
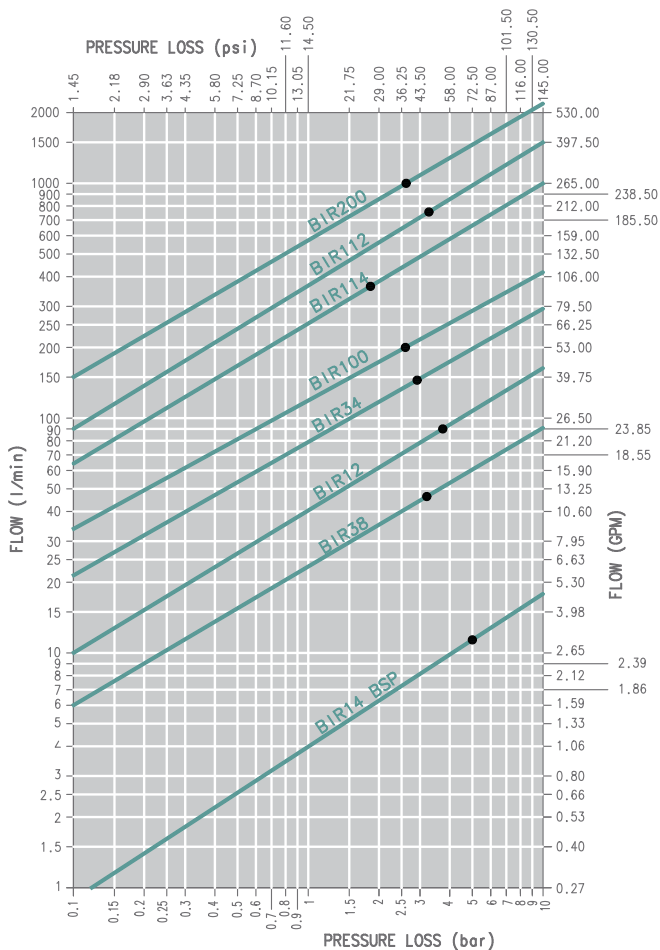

## Poppet: Interchange Coupling Size Diagram

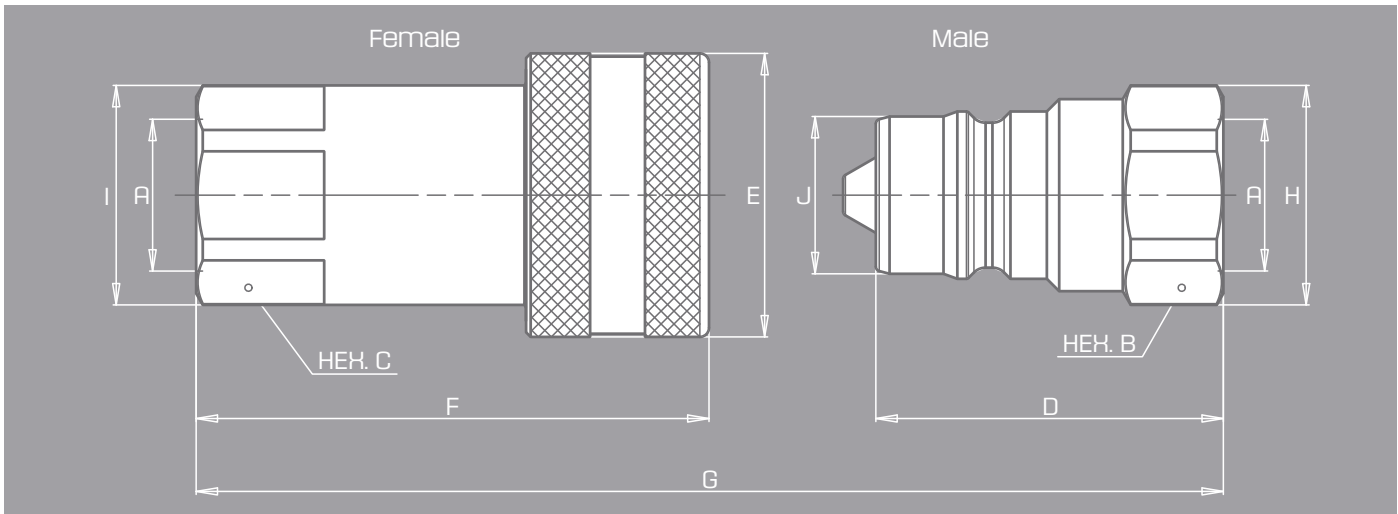

DESCRIPTION	BODY SIZE	A	UNIT	B	C	D	E	F	G	H	I	J	UNIT	WEIGHT	
														MALE	FEMALE
BIR14	1/4	1/4	mm	19.0	19.0	32.0	26.0	47.1	64.8	20.8	22.0	11.8	Kg	0.033	0.094
			inch	0.75	0.75	1.26	1.02	1.85	2.55	0.82	0.87	0.46	lb	0.07	0.21
BIR38	3/8	3/8	mm	22.0	22.0	38.0	31.0	56.1	76.8	24.0	24.0	17.3	Kg	0.053	0.145
			inch	0.87	0.87	1.50	1.22	2.21	3.02	0.94	0.94	0.68	lb	0.12	0.32
BIR12	1/2	1/2	mm	27.0	27.0	44.5	38.0	63.3	86.3	29.0	30.0	20.5	Kg	0.084	0.245
			inch	1.06	1.06	1.75	1.50	2.49	3.40	1.14	1.18	0.81	lb	0.19	0.54
BIR34	3/4	3/4	mm	36.0	38.0	55.0	48.0	82.2	111.1	38.5	44.0	29.1	Kg	0.210	0.502
			inch	1.42	1.50	2.17	1.89	3.24	4.37	1.52	1.73	1.15	lb	0.46	1.11
BIR100	1	1	mm	41.0	45.0	63.1	54.0	97.1	127.3	44.8	52.0	34.3	Kg	0.284	0.772
			inch	1.61	1.77	2.48	2.13	3.82	5.01	1.76	2.05	1.35	lb	0.63	1.70
BIR114	1 1/4	1 1/4	mm	55.0	50.0	75.0	65.0	117.2	151.2	60.0	55.5	45.0	Kg	0.615	1.244
			inch	2.17	1.97	2.95	2.56	4.61	5.95	2.36	2.19	1.77	lb	1.36	2.74
BIR112	1 1/2	1 1/2	mm	60.0	60.0	85.0	80.0	135.3	171.3	65.5	65.5	55.0	Kg	0.878	2.130
			inch	2.36	2.36	3.35	3.15	5.33	6.74	2.58	2.58	2.17	lb	1.94	4.70
BIR200	2	2	mm	75.0	75.0	100.0	100.0	160.2	201.2	82.5	83.7	65.0	Kg	1.440	4.130
			inch	2.95	2.95	3.94	3.94	6.31	7.92	3.25	3.30	2.56	lb	3.17	9.10



### BIR NPT Thread\_Poppet Style Interchange Coupling

PART	BODY SIZE	PORT SIZE	THREAD TYPE	ORDER CODE	PART DESCRIPTION
<b>BIR NPT THREAD</b>					
COUPLER	1/4	1/4	NPT	800501000	F. BIR 14 NPT
NIPPLE	1/4	1/4	NPT	800501001	M. BIR 14 NPT
COUPLER	3/8	3/8	NPT	800501002	F. BIR 38 NPT
NIPPLE	3/8	3/8	NPT	800501003	M. BIR 38 NPT
COUPLER	1/2	1/2	NPT	800501004	F. BIR 12 NPT
NIPPLE	1/2	1/2	NPT	800501005	M. BIR 12 NPT
COUPLER	3/4	3/4	NPT	800501006	F. BIR 34 NPT
NIPPLE	3/4	3/4	NPT	800501007	M. BIR 34 NPT
COUPLER	1	1	NPT	800501008	F. BIR 100 NPT
NIPPLE	1	1	NPT	800501009	M. BIR 100 NPT
COUPLER	1 1/4	1 1/4	NPT	800501010	F. BIR 114 NPT
NIPPLE	1 1/4	1 1/4	NPT	800501011	M. BIR 114 NPT
COUPLER	1 1/2	1 1/2	NPT	800501012	F. BIR 112 NPT
NIPPLE	1 1/2	1 1/2	NPT	800501013	M. BIR 112 NPT
COUPLER	2	2	NPT	800501014	F. BIR 200 NPT
NIPPLE	2	2	NPT	800501015	M. BIR 200 NPT
<b>BIR SAE THREAD</b>					
COUPLER	1/2	1/2	SAE	800504004	F. BIR 12 SAE
NIPPLE	1/2	1/2	SAE	800504005	M. BIR 12 SAE
COUPLER	3/4	3/4	SAE	800504006	F. BIR 34 SAE
NIPPLE	3/4	3/4	SAE	800504007	M. BIR 34 SAE
COUPLER	1	1	SAE	800504008	F. BIR 100 SAE
NIPPLE	1	1	SAE	800504009	M. BIR 100 SAE
<b>BIR NPT THREAD - 12 PC</b>					
COUPLER	1/2	1/2	NPT	805601000	F. BIR 12 PC NPT*
NIPPLE	1/2	1/2	NPT	805601001	M. BIR 12 PC NPT*
<b>BIR SAE THREAD - 12 PC</b>					
COUPLER	1/2	1/2	SAE	805604000	F. BIR 12 PC SAE*
NIPPLE	1/2	1/2	SAE	805604001	M. BIR 12 PC SAE*



COUPLER



NIPPLE



\* CONNECT UNDER RESIDUAL PRESSURE POPPET VALVE

# ISO A Interchange Couplings Push Pull Mount



## Poppet: Interchange Coupling

### Series: I-IP

**Interchange:** Faster CPV – CNV, Parker 4200

I-IP series is an extension of the ISO A style couplings and is one of the most popular designs worldwide used in agricultural, mobile equipment, and some industrial applications. The IP series is the ISO A interchange coupler with a push pull mounting feature. The I series is the nipple with a modular port design to allow for a range of port options. The Stucchi range is 1/4 thru 1 inch, with port options of NPT, SAE, BSP and DIN.

### Technical Characteristics

- Connection: pushing the male coupling
- Disconnection: pulling the male coupling
- Shut-off system: poppet valve
- Connectability: without pressure
- Panel mounting by the sleeve
- Suitable for flexible hose connections
- Breakaway feature (if panel mounted)

### Applications & Features

- Quick-release couplings mainly used in agriculture
- Push-Pull system makes connection and disconnection very easy
- Conformity to ISO 7241-1-A standards ensures worldwide interchangeability







DESCRIPTION	SIZE	ISO SIZE	MAX. OPERATING PRESSURE COUPLED		SPILLAGE *
			MPa	psi	ml
I-IP14	1/4	-	35	5076	0.70
I-IP38	3/8	10.0	31.5	4568	1.20
I-IP12	1/2	12.5	25	3571	2.10
I-IP34	3/4	20.0	25	3571	5.20
I-IP100	1	25.0	25	3571	9

\* SPILLAGE IS AN INDICATIVE VALUE OF THE FLUID LOSS PER COUPLE-UNCUPLE CYCLE

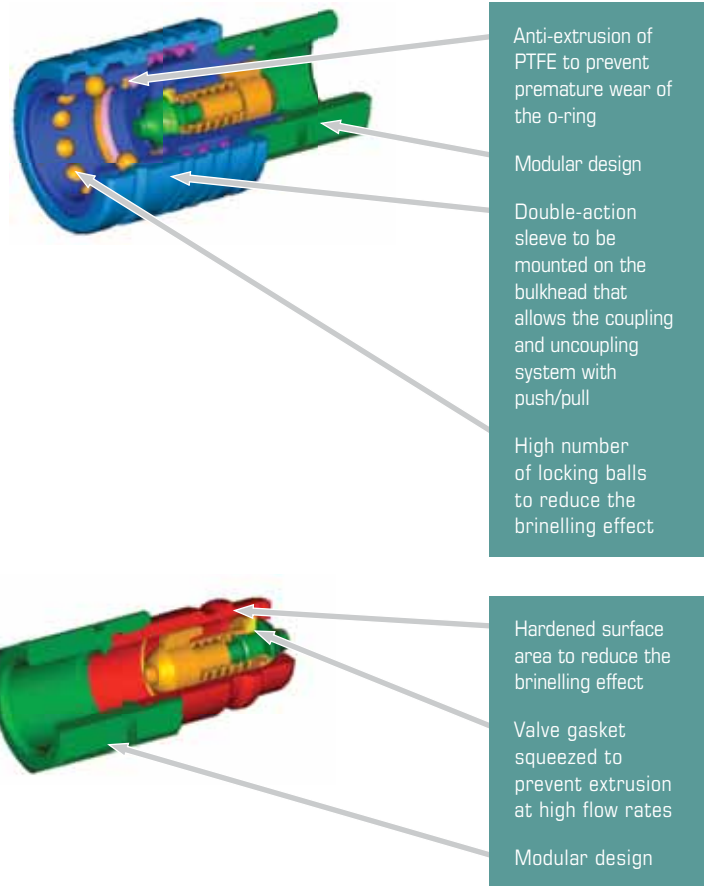
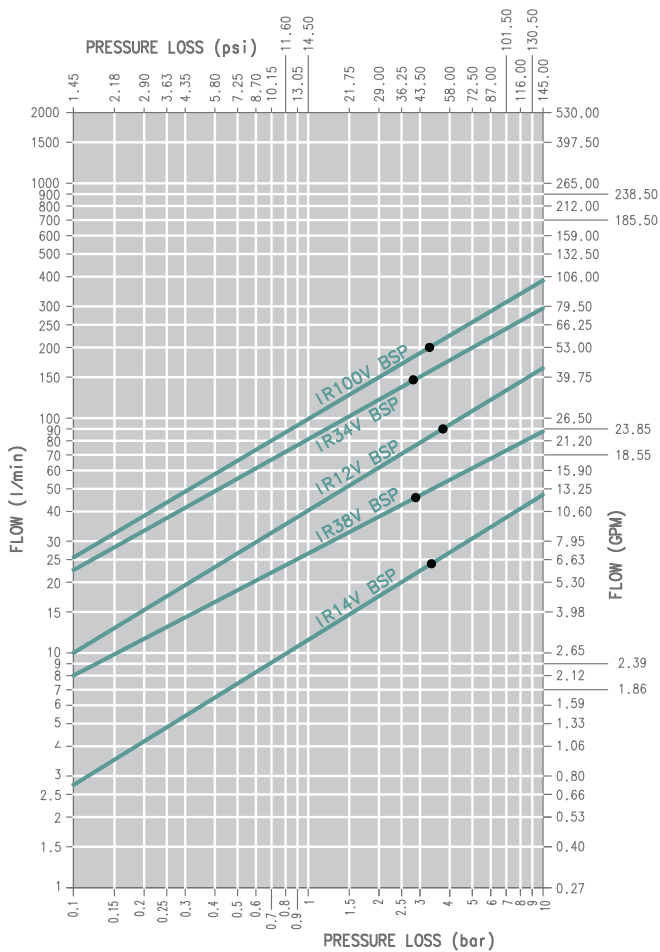

## Poppet: Interchange Coupling Size Diagram

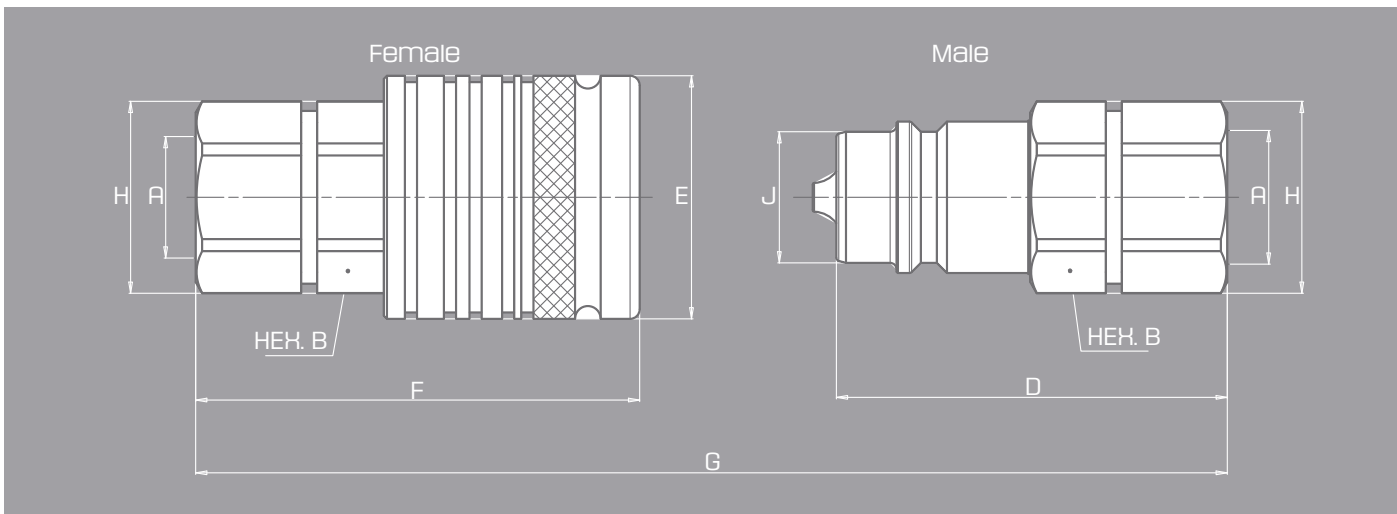

DESCRIPTION	BODY SIZE	A	DIMENSION	B	D	E	F	H	I
IP38/I38	3/8	3/8	mm	22	48.3	32	66.5	24	24
			inch	0.87	1.9	1.26	2.62	0.94	0.94
IP12/I12	1/2	1/2	mm	27	61.1	38	69.4	30	30
			inch	1.06	2.41	1.5	2.73	1.18	1.18
IP34/I34	3/4	3/4	mm	36	61	46	88	40	40
			inch	1.42	2.4	1.81	3.46	1.57	1.57
IP100/I100	1	1	mm	41	73	54	107	45	45
			inch	1.61	2.87	2.13	4.21	1.77	1.77



### I-IP BSP and NPT Thread\_Poppet Style Interchange Coupling

PART	BODY SIZE	PORT SIZE	THREAD TYPE	ORDER CODE	PART DESCRIPTION
<b>I-IP BSP AND NPT THREAD</b>					
COUPLER	3/8	1/4	BSP	809400008	INN. F. IP38 1/4 BSP
NIPPLE	3/8	1/4	BSP	809400009	INN. M. I38 1/4 BSP
COUPLER	3/8	3/8	BSP	809400010	INN. F. IP38 3/8 BSP
NIPPLE	3/8	3/8	BSP	809400011	INN. M. I38 3/8 BSP
COUPLER	3/8	3/8	MALE BSP	809400012	F. IP38 3/8BSP EST DIN3852
NIPPLE	3/8	3/8	MALE BSP	809400013	M. I38 3/8 BSP EST DIN3852
COUPLER	1/2	1/2	BSP	809400000	F. IP12 1/2 BSP
NIPPLE	1/2	1/2	BSP	809400001	M. I12GS 1/2 BSP
COUPLER	1/2	1/2	MALE BSP	809400002	F. IP12 1/2 BSP EST
NIPPLE	1/2	1/2	MALE BSP	809400003	M. I12GS 1/2 BSP EST
COUPLER	1/2	3/8	BSP	809400004	F. IP12 3/8 BSP
NIPPLE	1/2	3/8	BSP	809400005	M. I12GS 3/8 BSP
NIPPLE	1/2	3/8	MALE BSP	809400007	M. I12GS 3/8 BSP EST
COUPLER	1/2	1/2	NPT	809401000	F. IP12 1/2 NPT
NIPPLE	1/2	1/2	NPT	809401001	M. I12GS 1/2 NPT
COUPLER	3/4	3/4	BSP	809400014	F. I34 3/4 BSP
NIPPLE	3/4	3/4	BSP	809400015	M. I34 3/4 BSP
NIPPLE	3/4	3/4	NPT	809401003	M. I34 3/4 NPT
COUPLER	1	3/4	BSP	809400016	INN. F. IP100 3/4 BSP
NIPPLE	1	3/4	BSP	809400017	INN. M. I100 3/4 BSP
COUPLER	1	1	BSP	809400018	INN. F. IP100 1 BSP
NIPPLE	1	1	BSP	809400019	INN. M. I100 1 BSP



COUPLER



NIPPLE

# ISO B Interchange Coupling



## Technical Characteristics:

- NPT standard threads
- Anti-extrusion rings are in pure Teflon (PTFE)
- Springs in AISI 302 stainless steel
- On request BSP threads and various seals

## Poppet: Interchange Coupling

Series: IRB | IRBX | IRBO

**Interchange:** ISO B

The series IRB quick couplings, are interchangeable to ISO 7241-1 series B. The series IRB most important characteristics are compactness, and highest quality raw material used in manufacturing.

**Interchange:** Parker 60, Aeroquip FD45, Faster HNV

- IRB: carbon steel material with Nitrile seals
- IRBO: brass material with Viton seals
- IRBX: 316 stainless steel with Viton seals





DESCRIPTION	SIZE	ISO SIZE	MAX. OPERATING PRESSURE COUPLED		BURST PRESSURE						SPILLAGE*
					COUPLED		MALE		FEMALE		
			MPa	psi	MPa	psi	MPa	psi	MPa	psi	
<b>IRB STEEL</b>											
IRB18	1/8	5.0	35	5075	120	17400	120	17400	120	17400	0.18
IRB14	1/4	6.3	35	5075	100	14500	100	14500	100	14500	0.33
IRB38	3/8	10.0	30	4350	100	14500	100	14500	100	14500	2.20
IRB12	1/2	12.5	28	4060	100	14500	100	14500	100	14500	3.00
IRB34	3/4	20.0	23	4000	100	14500	100	14500	100	14500	9.40
IRB100	1	25.0	18	4000	80	11600	80	11600	80	11600	14.00
<b>IRBX 316 STAINLESS STEEL</b>											
IRBX18	1/8	5.0	25	3625	140	20300	140	20300	140	20300	0.18
IRBX14	1/4	6.3	25	3625	140	20300	140	20300	140	20300	0.33
IRBX38	3/8	10.0	20	2900	100	14500	100	14500	100	14500	2.20
IRBX12	1/2	12.5	20	2900	100	14500	100	14500	100	14500	3.00
IRBX34	3/4	20.0	16	2320	80	11600	80	11600	80	11600	9.40
IRBX100	1	25.0	12,5	1813	60	8700	60	8700	60	8700	14.00
<b>IRBO BRASS</b>											
IRBO18	1/8	5.0	20	2900	100	14500	100	14500	100	14500	0.18
IRBO14	1/4	6.3	20	2900	100	14500	100	14500	100	14500	0.33
IRBO38	3/8	10.0	16	2320	80	11600	70	10150	80	11600	2.20
IRBO12	1/2	12.5	16	2320	80	11600	70	10150	80	11600	3.00
IRBO34	3/4	20.0	12,5	1813	60	8700	45	6525	60	8700	9.40
IRBO100	1	25.0	10	1450	40	5800	40	5800	40	5800	14.00

\* SPILLAGE IS AN INDICATIVE VALUE OF THE FLUID LOSS PER COUPLE-UNCUPLE CYCLE

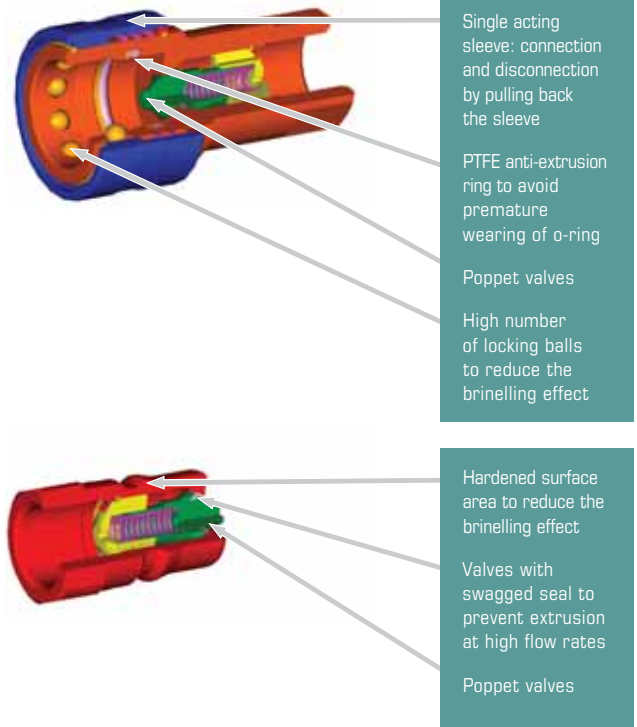
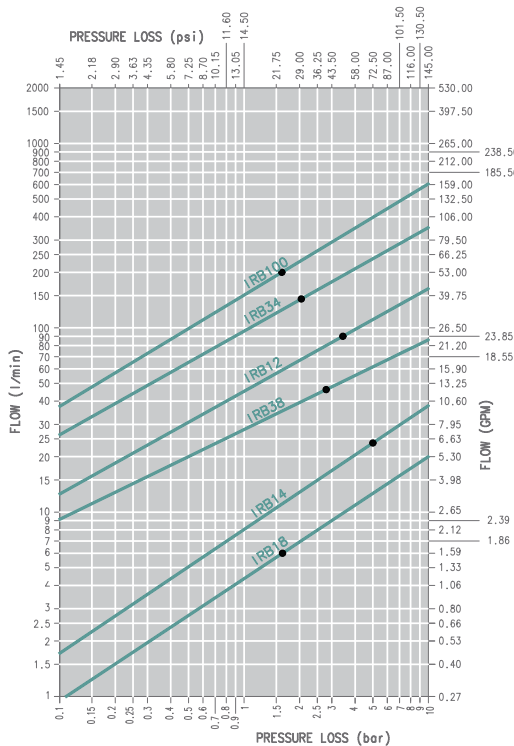

## Poppet: Interchange Coupling Size Diagram

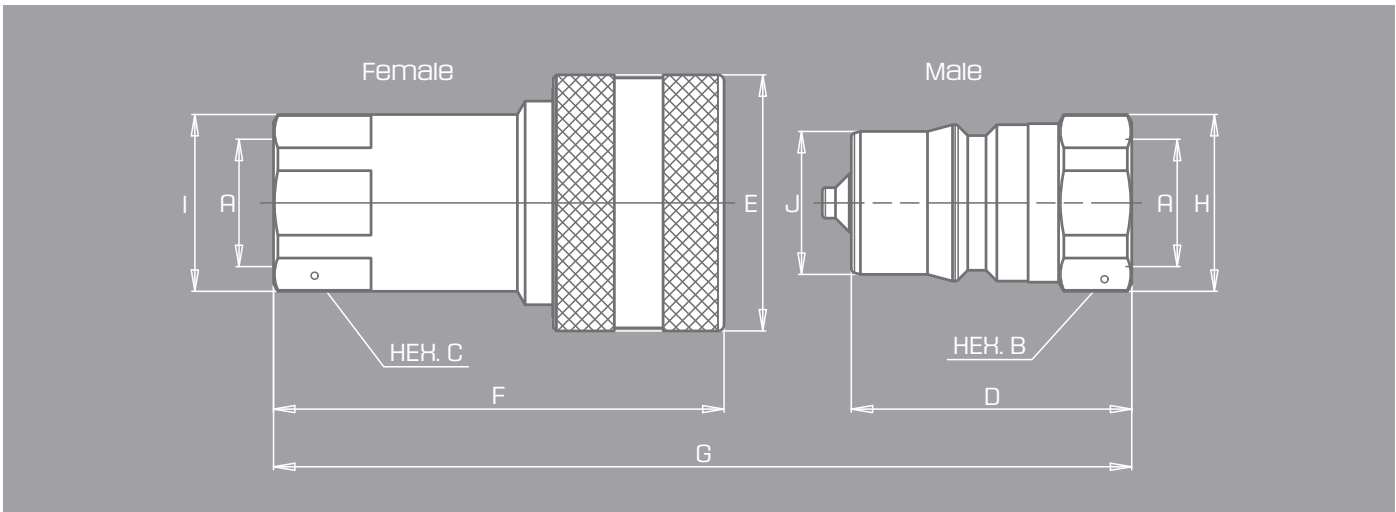

DESCRIPTION	BODY SIZE	A	UNIT	B	C	D	E	F	G	H	I	J	UNIT	WEIGHT	
														MALE	FEMALE
IRB18	1/8	1/8	mm	14.0	14.0	30.0	23.0	48.8	60.5	15.8	15.8	10.8	Kg	0.018	0.068
			inch	0.55	0.55	1.18	0.91	1.92	2.38	0.62	0.62	0.43	lb	0.04	0.15
IRB14	1/4	1/4	mm	19.0	19.0	35.0	27.0	57.0	70.7	20.8	21.2	14.2	Kg	0.035	0.120
			inch	0.75	0.75	1.38	1.06	2.24	2.78	0.82	0.83	0.56	lb	0.08	0.26
IRB38	3/8	3/8	mm	24.0	24.0	41.0	34.0	66.0	82.7	26.0	27.0	19.1	Kg	0.068	0.220
			inch	0.94	0.94	1.61	1.34	2.60	3.26	1.02	1.06	0.75	lb	0.15	0.49
IRB12	1/2	1/2	mm	27.0	27.0	46.0	42.0	73.9	92.6	29.0	29.0	23.5	Kg	0.102	0.323
			inch	1.06	1.06	1.81	1.65	2.91	3.65	1.14	1.14	0.93	lb	0.22	0.71
IRB34	3/4	3/4	mm	36.0	36.0	55.0	50.0	90.1	111.1	38.5	38.5	31.4	Kg	0.203	0.562
			inch	1.42	1.42	2.17	1.97	3.55	4.37	1.52	1.52	1.24	lb	0.45	1.24
IRB100	1	1	mm	41.0	41.0	66.0	60.0	106.2	133.2	44.8	44.8	37.7	Kg	0.328	0.863
			inch	1.61	1.61	2.60	2.36	4.18	5.24	1.76	1.76	1.48	lb	0.72	1.90





**IRB NPT and SAE Thread**\_Poppet Style Interchange Coupling | Steel

PART	BODY SIZE	PORT SIZE	THREAD TYPE	ORDER CODE	PART DESCRIPTION
<b>IRB NPT THREAD</b>					
COUPLER	1/8	1/8	NPT	800601000	F. IRB 18 NPT
NIPPLE	1/8	1/8	NPT	800601001	M. IRB 18 NPT
COUPLER	1/4	1/4	NPT	800601002	F. IRB 14 NPT
NIPPLE	1/4	1/4	NPT	800601003	M. IRB 14 NPT
COUPLER	3/8	3/8	NPT	800601004	F. IRB 38 NPT
NIPPLE	3/8	3/8	NPT	800601005	M. IRB 38 NPT
COUPLER	1/2	1/2	NPT	800601006	F. IRB 12 NPT
NIPPLE	1/2	1/2	NPT	800601007	M. IRB 12 NPT
COUPLER	3/4	3/4	NPT	800601008	F. IRB 34 NPT
NIPPLE	3/4	3/4	NPT	800601009	M. IRB 34 NPT
COUPLER	1	1	NPT	800601010	F. IRB 100 NPT
NIPPLE	1	1	NPT	800601011	M. IRB 100 NPT
<b>IRB SAE THREAD</b>					
COUPLER	1/4	3/8	SAE	800604202	F. IRBS 14E 3/8 SAE
NIPPLE	1/4	3/8	SAE	800604201	M. IRB 14E 3/8 SAE



COUPLER



NIPPLE

**IRBO NPT Thread**\_Poppet Style Interchange Coupling | Brass

PART	BODY SIZE	PORT SIZE	THREAD TYPE	ORDER CODE	PART DESCRIPTION
<b>IRBO NPT THREAD</b>					
COUPLER	1/8	1/8	NPT	804501100	F. IRBOV 18 NPT
NIPPLE	1/8	1/8	NPT	804501101	M. IRBOV 18 NPT
COUPLER	1/4	1/4	NPT	804501102	F. IRBOV 14 NPT
NIPPLE	1/4	1/4	NPT	804501103	M. IRBOV 14 NPT
COUPLER	3/8	3/8	NPT	804501104	F. IRBOV 38 NPT
NIPPLE	3/8	3/8	NPT	804501105	M. IRBOV 38 NPT
COUPLER	1/2	1/2	NPT	804501106	F. IRBOV 12 NPT
NIPPLE	1/2	1/2	NPT	804501107	M. IRBOV 12 NPT
COUPLER	3/4	3/4	NPT	804501108	F. IRBOV 34 NPT
NIPPLE	3/4	3/4	NPT	804501109	M. IRBOV 34 NPT
COUPLER	1	1	NPT	804501110	F. IRBOV 100 NPT
NIPPLE	1	1	NPT	804501111	M. IRBOV 100 NPT



COUPLER



NIPPLE

# ISO B Interchange Coupling



COUPLER



NIPPLE

## IRBX NPT Thread\_Poppet Style Interchange Coupling | Stainless Steel

PART	BODY SIZE	PORT SIZE	THREAD TYPE	ORDER CODE	PART DESCRIPTION
<b>IRBX NPT THREAD</b>					
COUPLER	1/8	1/8	NPT	804601100	F. IRBX 18 NPT
NIPPLE	1/8	1/8	NPT	804601101	M. IRBX 18 NPT
COUPLER	1/4	1/4	NPT	804601102	F. IRBX 14 NPT
NIPPLE	1/4	1/4	NPT	804601103	M. IRBX 14 NPT
COUPLER	3/8	3/8	NPT	804601104	F. IRBX 38 NPT
NIPPLE	3/8	3/8	NPT	804601105	M. IRBX 38 NPT
COUPLER	1/2	1/2	NPT	804601106	F. IRBX 12 NPT
NIPPLE	1/2	1/2	NPT	804601107	M. IRBX 12 NPT
COUPLER	3/4	3/4	NPT	804601108	F. IRBX 34 NPT
NIPPLE	3/4	3/4	NPT	804601109	M. IRBX 34 NPT
COUPLER	1	1	NPT	804601110	F. IRBX 100 NPT
NIPPLE	1	1	NPT	804601111	M. IRBX 100 NPT

AVAILABLE WITHOUT VALVE UPON REQUEST



## Poppet: Interchange Coupling

Series: IR | IRV | IRS

**Interchange:** Agriculture/ISO 5675

The series IR, IR/V hydraulic quick couplings equipped with ball or poppet sealing valve are mostly applied in agricultural equipment; interchangeable according to ISO 5675. Size 12.5 is in accordance with ISO 7241-1 series "A".

- IR: ball seal valve
- IRV: poppet seal valve
- IRS: push pull coupling
- IRS PC: push pull sleeve connectable under residual pressure

### Overview

Stucchi Agriculture Series are offered with a choice of either ball or poppet valve mechanisms for automatic shut-off during disconnection. The ball mechanism is the IR series, the poppet mechanism is the IRV series. The IR series are mainly for applications where interchangeability with existing equipment is necessary. For new applications poppet valves or flat face are recommended.

### Technical Characteristics & Options

- Coupling constructed in carbon steel with zinc plating
- Nipple made with hardened steel
- Standard seals are Nitrile
- NPT standard threads
- On request SAE, BSP threads
- Anti-dust plastic caps
- Clip provided Nylon caps for IR12 female part



# Agriculture Interchange Coupling

DESCRIPTION	SIZE	ISO SIZE	MAX. OPERATING PRESSURE COUPLED		BURST PRESSURE						SPILLAGE*
					COUPLED		MALE		FEMALE		
			MPa	psi	MPa	psi	MPa	psi	MPa	psi	
IR14	1/4	-	30	4350	100	14500	100	14500	100	14500	0.13
IR38	3/8	-	30	4350	100	14500	100	14500	90	13050	0.45
IR12	1/2	12.5	25	3625	80	11600	55	7975	55	7975	2.30
IR34	3/4	-	25	3625	100	14500	60	8700	90	13050	4.50
IR100	1	-	20	2900	80	11600	60	8700	80	11600	6.00

\* SPILLAGE IS AN INDICATIVE VALUE OF THE FLUID LOSS PER COUPLE-UNCUPLE CYCLE.

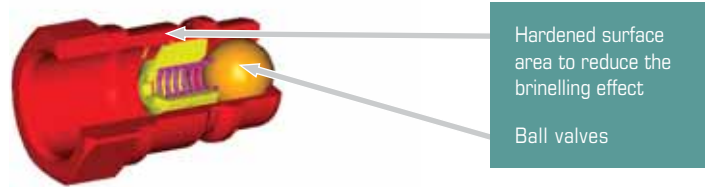
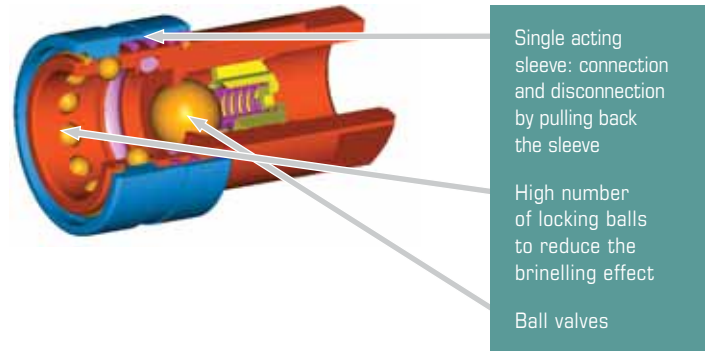
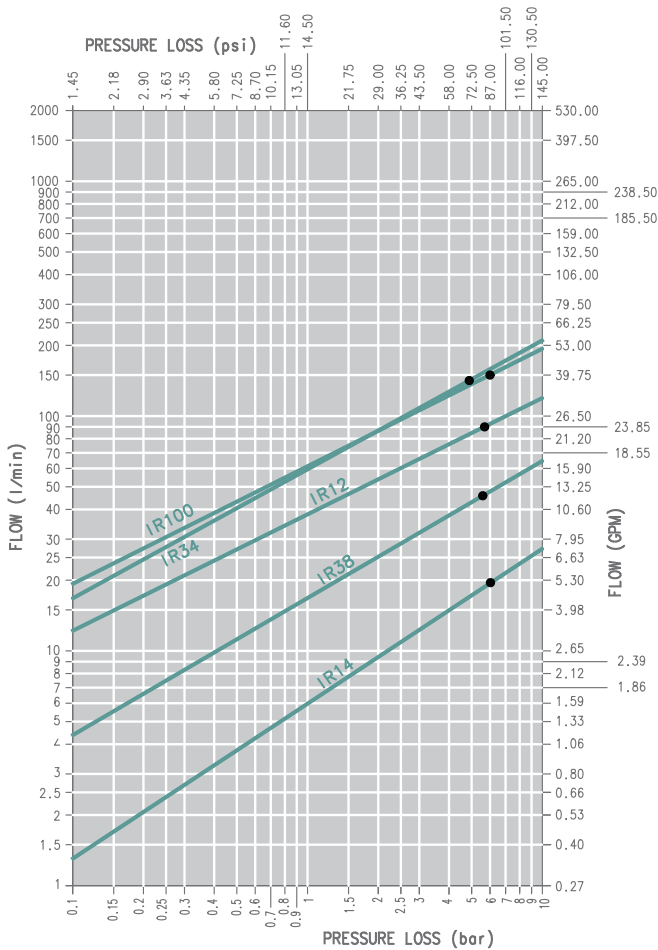



## Poppet: Interchange Coupling Size Diagram

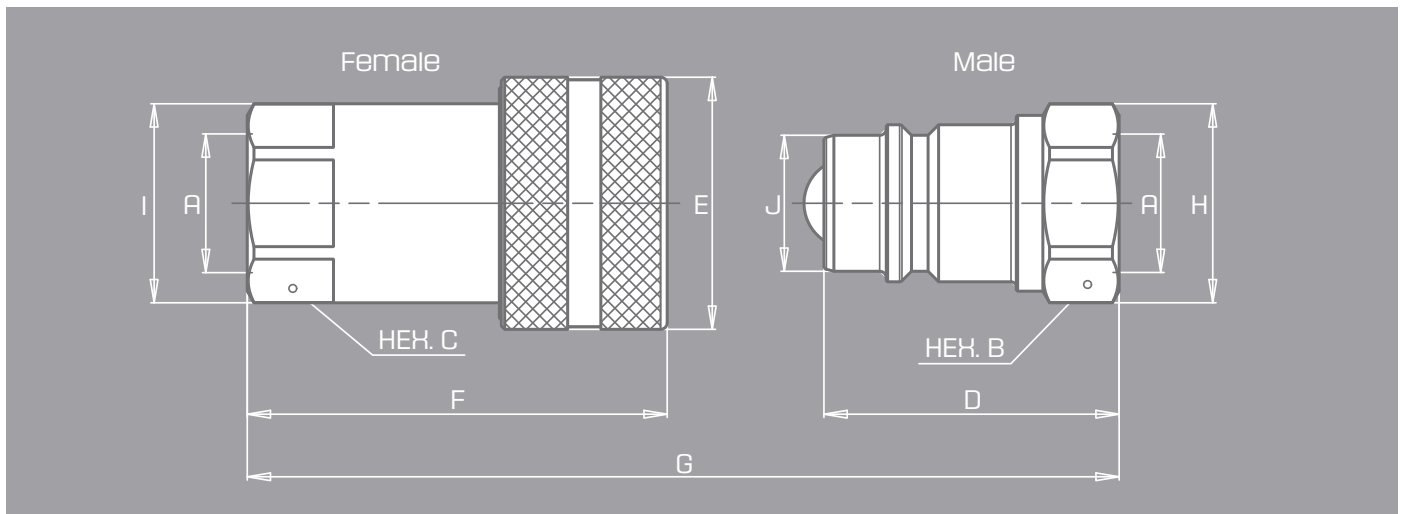

DESCRIPTION	BODY SIZE	A	UNIT	B	C	D	E	F	G	H	I	J	UNIT	WEIGHT	
														MALE	FEMALE
IR14	1/4	1/4	mm	19.0	19.0	32.5	27.0	48.9	64.4	22.0	21.0	14.2	Kg	0.040	0.125
			inch	0.75	0.75	1.28	1.06	1.93	2.54	0.87	0.83	0.56	lb	0.09	0.28
IR38	3/8	3/8	mm	24.0	24.0	38.0	34.0	58.3	76.3	27.7	26.5	19.0	Kg	0.080	0.222
			inch	0.94	0.94	1.50	1.34	2.30	3.00	1.09	1.04	0.75	lb	0.18	0.49
IR12	1/2	1/2	mm	27.0	27.0	44.5	38.0	63.3	86.3	30.0	30.0	20.5	Kg	0.090	0.277
			inch	1.06	1.06	1.75	1.50	2.49	3.40	1.18	1.18	0.81	lb	0.20	0.61
IR34	3/4	3/4	mm	36.0	38.0	59.0	48.0	90.3	118.3	38.5	43.0	26.9	Kg	0.211	0.699
			inch	1.42	1.50	2.32	1.89	3.56	4.66	1.52	1.69	1.06	lb	0.47	1.54
IR100	1	1	mm	41.0	45.0	66.1	54.0	99.6	132.8	44.8	52.0	31.4	Kg	0.301	0.894
			inch	1.61	1.77	2.60	2.13	3.92	5.23	1.76	2.05	1.24	lb	0.66	1.97

# Agriculture Interchange Coupling

DESCRIPTION	SIZE	ISO SIZE	MAX. OPERATING PRESSURE COUPLED		BURST PRESSURE						SPILLAGE*
					COUPLED		MALE		FEMALE		
			MPa	psi	MPa	psi	MPa	psi	MPa	psi	
IR14V	1/4	-	30	4350	100	14500	100	14500	100	14500	0.33
IR38V	3/8	-	30	4350	100	14500	100	14500	100	14500	1.30
BIR12	1/2	12.5	25	3625	80	11600	80	11600	100	14500	2.10
IR34V	3/4	-	25	3625	100	14500	90	13050	100	14500	4.20
IR100V	1	-	20	2900	80	11600	80	11600	80	11600	5.50

\* SPILLAGE IS AN INDICATIVE VALUE OF THE FLUID LOSS PER COUPLE-UNCUPLE CYCLE.

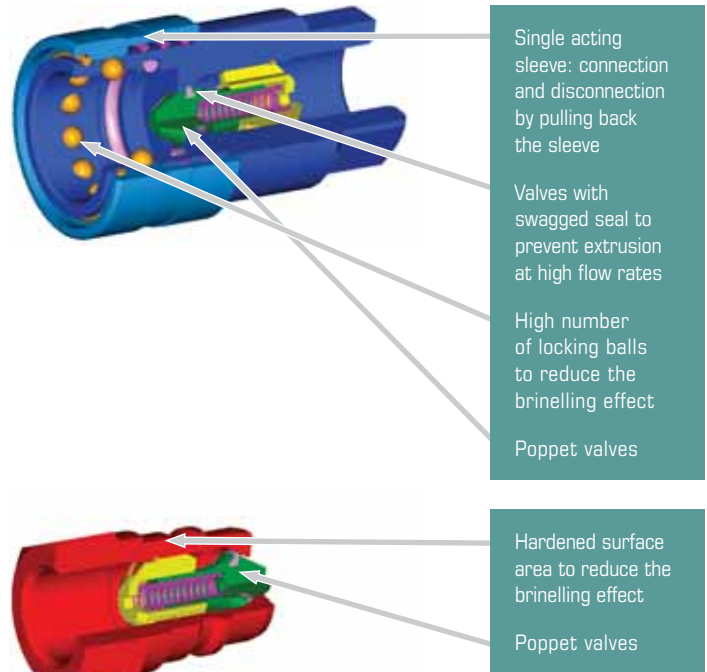
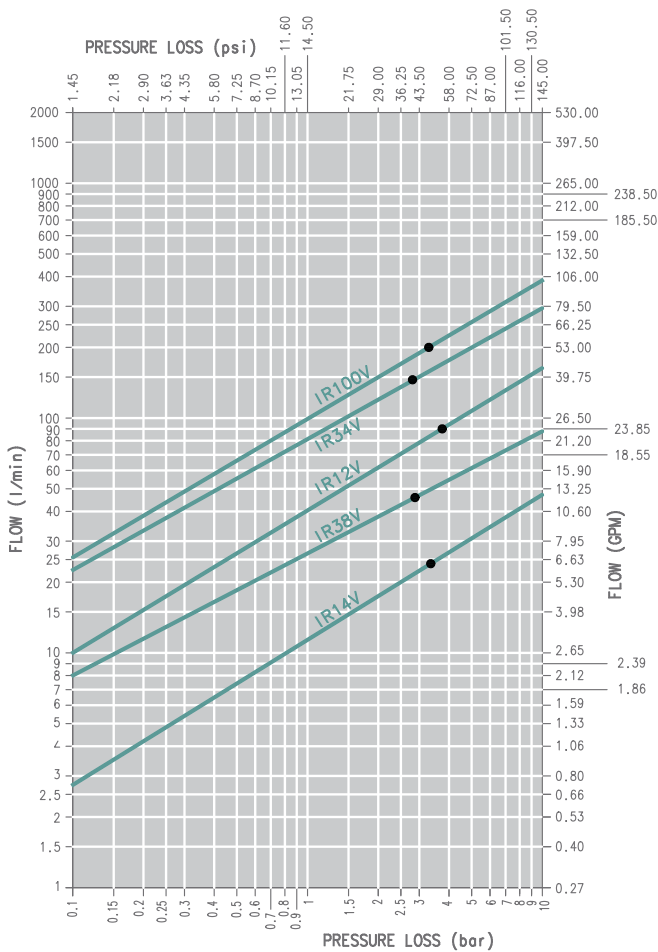





## Poppet: Interchange Coupling Size Diagram

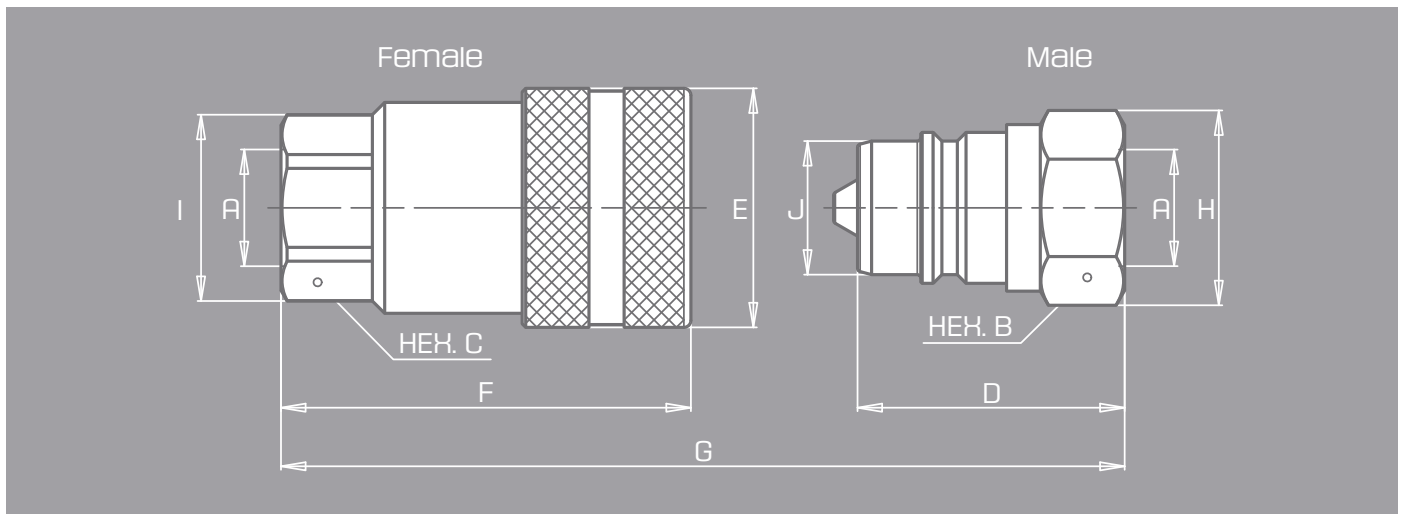

DESCRIPTION	BODY SIZE	A	UNIT	B	C	D	E	F	G	H	I	J	UNIT	WEIGHT	
														MALE	FEMALE
IR14V	1/4	1/4	mm	19.0	19.0	32.5	27.0	50.4	65.9	22.0	21.0	14.2	Kg	0.040	0.125
			inch	0.75	0.75	1.28	1.06	1.98	2.59	0.87	0.83	0.56	lb	0.09	0.28
IR38V	3/8	3/8	mm	24.0	24.0	38.0	34.0	58.3	76.3	27.7	26.5	19.0	Kg	0.080	0.222
			inch	0.94	0.94	1.50	1.34	2.30	3.00	1.09	1.04	0.75	lb	0.18	0.49
BIR12	1/2	1/2	mm	27.0	27.0	44.5	38.0	63.3	86.3	29.0	30.0	20.5	Kg	0.084	0.245
			inch	1.06	1.06	1.75	1.50	2.49	3.40	1.14	1.18	0.81	lb	0.19	0.54
IR34V	3/4	3/4	mm	36.0	38.0	59.0	48.0	90.3	118.3	38.5	43.0	26.9	Kg	0.187	0.663
			inch	1.42	1.50	2.32	1.89	3.56	4.66	1.52	1.69	1.06	lb	0.41	1.46
IR100V	1	1	mm	41.0	45.0	64.1	54.0	97.6	128.8	44.8	52.0	31.4	Kg	0.276	0.860
			inch	1.61	1.77	2.52	2.13	3.84	5.07	1.76	2.05	1.24	lb	0.61	1.90

# Agriculture Interchange Coupling



COUPLER



NIPPLE

## IRV NPT and SAE Thread\_Poppet Style Interchange Coupling

PART	BODY SIZE	PORT SIZE	THREAD TYPE	ORDER CODE	PART DESCRIPTION
<b>IRV NPT THREAD</b>					
COUPLER	1/4	1/4	NPT	800101000	F. IR 14V NPT
NIPPLE	1/4	1/4	NPT	800101001	M. IR 14V NPT
COUPLER	3/8	3/8	NPT	800101002	F. IR 38V NPT
NIPPLE	3/8	3/8	NPT	800101003	M. IR 38V NPT
COUPLER	1/2	1/2	NPT	800501004	F. BIR 12 NPT
NIPPLE	1/2	1/2	NPT	800501005	M.BIR 12 NPT
COUPLER	3/4	3/4	NPT	800101004	F. IR 34V NPT
NIPPLE	3/4	3/4	NPT	800101005	M. IR 34V NPT
COUPLER	1	1	NPT	800101006	F. IR 100V NPT
NIPPLE	1	1	NPT	800101007	M. IR 100V NPT
COUPLER	3/4	3/4	NPT	820001022	F. IR 34V FA NPT*
NIPPLE	3/4	3/4	NPT	820001023	M. IR 34V FA NPT*
<b>IRV SAE THREAD</b>					
COUPLER	1/4	3/8	SAE	800104000	F. IR 14V 38 SAE
NIPPLE	1/4	3/8	SAE	800104001	M. IR 14V 38 SAE

\* FASTER INTERCHANGE ONLY

## IRS V\_Poppet Valve | Agricultural Push/Pull Sleeve



COUPLER

PART	BODY SIZE	PORT SIZE	THREAD TYPE	ORDER CODE	PART DESCRIPTION
<b>IRS V NPT AND SAE THREAD</b>					
COUPLER	1/2	1/2	NPT	800401002	F. IRS 12VA NPT
COUPLER	1/2	1/2	SAE	804304004	F. I 12VA SAE

## IRS PC\_Poppet Valve | Agricultural Push/Pull Sleeve | Connect Under Pressure

PART	BODY SIZE	PORT SIZE	THREAD TYPE	ORDER CODE	PART DESCRIPTION
<b>IRS PC NPT AND SAE THREAD</b>					
COUPLER	1/2	1/2	NPT	800401004	F. IRS 12VA PC NPT
COUPLER	1/2	1/2	SAE	804304002	F. I 12VA PC SAE



### IR Ball Valve NPT Thread\_Poppet Style Interchange Coupling

PART	BODY SIZE	PORT SIZE	THREAD TYPE	ORDER CODE	PART DESCRIPTION
<b>IR BALL VALVE NPT THREAD</b>					
COUPLER	1/4	1/4	NPT	800001000	F. IR 14 NPT
NIPPLE	1/4	1/4	NPT	800001001	M. IR 14 NPT
COUPLER	3/8	3/8	NPT	800001002	F. IR 38 NPT
NIPPLE	3/8	3/8	NPT	800001003	M. IR 38 NPT
COUPLER	1/2	1/2	NPT	800001004	F. IR 12 NPT
NIPPLE	1/2	1/2	NPT	800001005	M. IR 12 NPT
COUPLER	3/4	3/4	NPT	800001006	F. IR 34 NPT
NIPPLE	3/4	3/4	NPT	800001007	M. IR 34 NPT
COUPLER	1	1	NPT	800001008	F. IR 100 NPT
NIPPLE	1	1	NPT	800001009	M. IR 100 NPT
COUPLER	3/4	3/4	NPT	820001020	F. IR 34 FA NPT*
NIPPLE	3/4	3/4	NPT	820001021	M. IR 34 FA NPT*

\* FASTER INTERCHANGE ONLY



COUPLER



NIPPLE

### IR TIC Ball Valve NPT Thread\_Agricultural Nipple with Seal Retainer

PART	BODY SIZE	PORT SIZE	THREAD TYPE	ORDER CODE	PART DESCRIPTION
<b>IR TIC BALL VALVE NPT THREAD</b>					
NIPPLE	1/2	1/2	NPT	800001011	M. IR 12 TIC NPT



NIPPLE

### IRS Ball Valve NPT Thread\_Agricultural Push/Pull Sleeve

PART	BODY SIZE	PORT SIZE	THREAD TYPE	ORDER CODE	PART DESCRIPTION
<b>IRS BALL VALVE NPT THREAD</b>					
COUPLER	1/2	1/2	NPT	800301002	F. IRS 12A NPT



COUPLER

# Wing Style Interchange Coupling



## Misc: Interchange Coupling

### Series: W

**Interchange:** Parker 6100

- Seals: Nitrile
- Threaded sleeve allows connection/disconnection under pressure
- Coupler: brass material
- Wing: cast steel
- Nipple: brass material

NOMINAL SIZE	RATED FLOW AT 50 PSI PRESSURE DROP	BURST PRESSURE	MAX WORKING PRESSURE	MAX WORKING PRESSURE
inch	gpm	psi	bar	psi
3/4	35	9000	207	3000
1	55	9000	207	3000
1 1/4	80	8250	190	2750
1 1/2	110	7500	172	2500

### W NPT Thread\_Wing Style Thread to Connect

PART	BODY SIZE	PORT SIZE	THREAD TYPE	ORDER CODE	PART DESCRIPTION
<b>W NPT THREAD</b>					
COUPLER	3/4	3/4	NPT	100610012	F. W6F6-B
NIPPLE	3/4	3/4	NPT	100610112	M. W6F6-B
COUPLER	1	1	NPT	100610016	F. W8F8-B
NIPPLE	1	1	NPT	100610116	M. W8F8-B
COUPLER	1 1/4	1 1/4	NPT	100610020	F. W10F10-B
NIPPLE	1 1/4	1 1/4	NPT	100610120	M. W10F10-B
COUPLER	1 1/2	1 1/2	NPT	100610024	F. W12F12-B
NIPPLE	1 1/2	1 1/2	NPT	100610124	M. W12F12-B

ORDER CODE	DESCRIPTION	CAP FOR COUPLER
200610012	F. CAP 6WDP-B	100610012
200610112	M. CAP W6DC-B	100610112
200610016	F. CAP 8WDP-B	100610016
200610116	M. CAP W8DP-B	100610116
200610020	F. CAP 10WDP-B	100610020
200610120	M. CAP W10DC-B	100610120
200610024	F. CAP 12WDP-B	100610024
200610124	M. CAP W12DC-B	100610124



# 10,000 psi Interchange Coupling



## Misc: Interchange Coupling

**Series:** IVHP

**Interchange:** Enerpac/Hydraulic Jack

- 10,000 psi working pressure
- Seals: Nitrile
- Material: hardened steel for higher burst pressure than competitors



# 10,000 psi Interchange Coupling

DESCRIPTION	NOMINAL SIZE	ISO SIZE	MAX. OPERATING PRESSURE COUPLED		BURST PRESSURE COUPLED	
	inch	mm	bar	psi	bar	psi
IVHP 1/4	1/4	6.3	700	10,000	2500	35,714
IVHP 3/8	3/8	10.0	700	10,000	2350	33,570

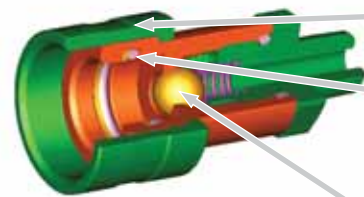
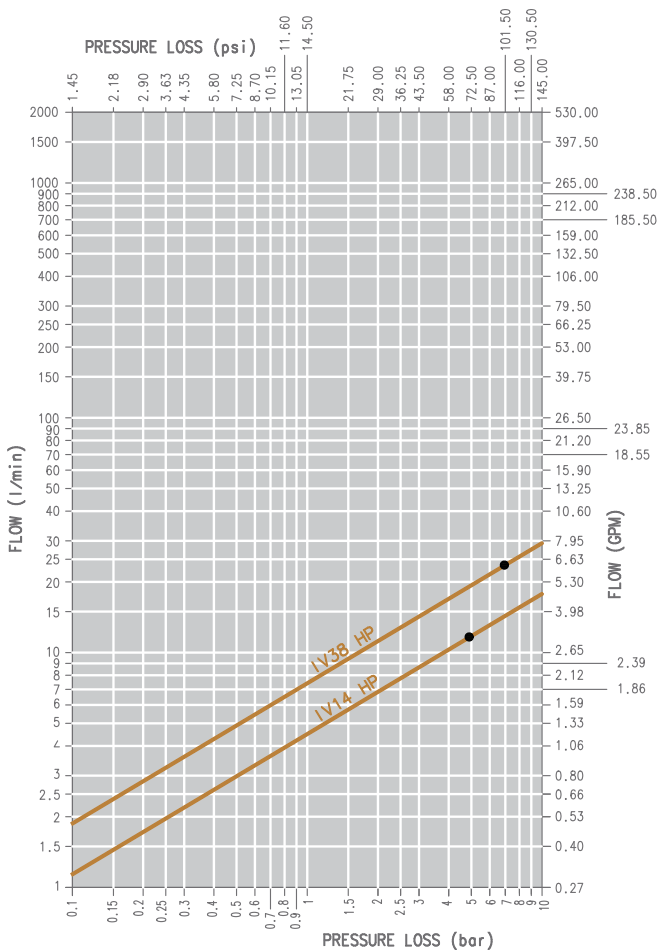

- Components in high resistance carbon steel
- Size 1/4: o-ring in Nitrile 90 shore
- Size 3/8: o-ring in Nitrile 90 shore with PTFE anti-extrusion
- Ball valves



- Screw mechanical connection
- Ball valves





## Misc: Interchange Coupling Size Diagram

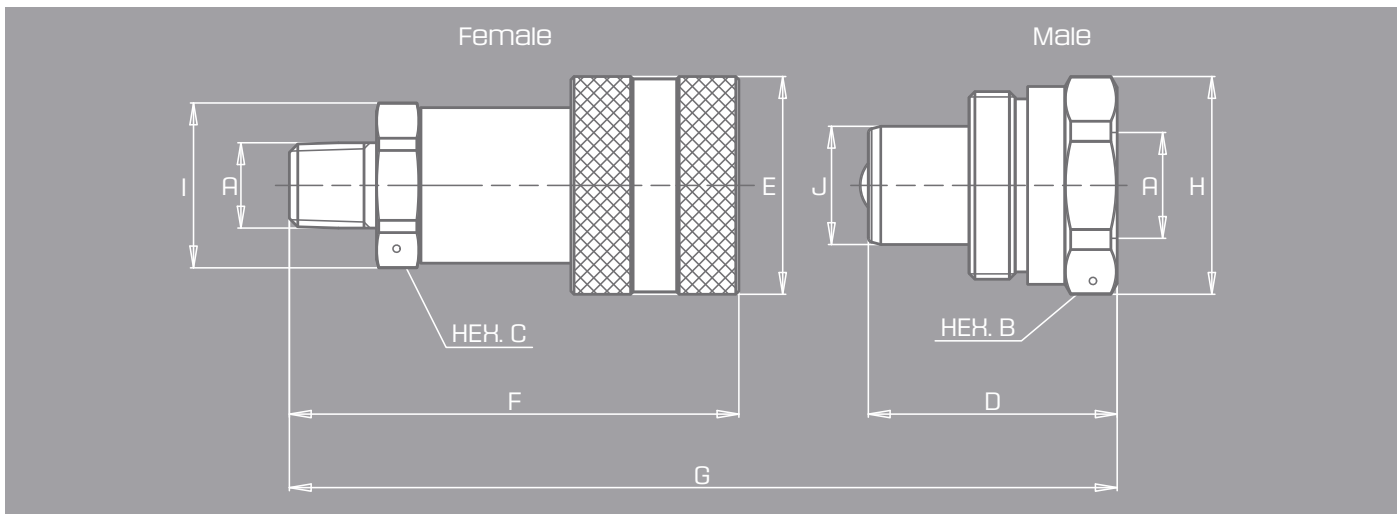

DESCRIPTION	BODY SIZE	UNIT	A	B	C	D	E	F	G	H	UNIT	WEIGHT
F-IV14HP	1/4	mm	28.0	20.5	98.0	24.0	-	-	-	-	Kg	0.045
		inch	1.10	0.81	3.86	0.94	-	-	-	-	lb	0.10
M-IV14HP	1/4	mm	-	-	-	-	28.0	28.5	98.0	24.0	Kg	0.040
		inch	-	-	-	-	1.10	1.12	3.86	0.94	lb	0.09
F-IV38HP	3/8	mm	35.0	23.5	110.0	24.0	-	-	-	-	Kg	0.070
		inch	1.38	0.93	4.33	0.94	-	-	-	-	lb	0.15
M-IV38HP	3/8	mm	-	-	-	-	35.0	36.6	110.0	24.0	Kg	0.095
		inch	-	-	-	-	1.38	1.44	4.33	0.94	lb	0.21

# Interchange Coupling



COUPLER

## IVHP 10,000 psi NPT Thread\_Thread to Connect High Pressure

PART	BODY SIZE	PORT SIZE	THREAD TYPE	ORDER CODE	PART DESCRIPTION
<b>IVHP NPT MALE AND FEMALE THREAD</b>					
COUPLER	1/4	1/4	NPT MALE	800201008	F. IVHP 1/4 NPT EXT
NIPPLE	1/4	1/4	NPT FEMALE	800201009	M. IVHP 1/4 NPT
COUPLER	3/8	3/8	NPT MALE	800201004	F. IVHP 3/8 NPT EXT
NIPPLE	3/8	3/8	NPT FEMALE	800201005	M. IVHP 3/8 NPT
NIPPLE	1/4	1/4	NPT MALE	800201010	M. IVHP 1/4 NPT
COUPLER	3/8	3/8	NPT FEMALE	800201014	F. IVHP 3/8 NPT

SIZE 3/8 AVAILABLE IN 316SS UPON REQUEST



NIPPLE

## IVHP\_Metal and Plastic Caps

ORDER CODE	DESCRIPTION
<b>IVHP METAL CAPS</b>	
815605002	CAP F. IV38HP
815605003	CAP M. IV38HP
815605004	CAP F. IV14HP
815605005	CAP M. IV14HP
<b>IVHP PLASTIC CAPS</b>	
815603010	CAP F. IV14HP BLACK PLASTIC
815603011	CAP M. IV14HP BLACK PLASTIC
815603012	CAP F. IV38HP BLACK PLASTIC
815603013	CAP M. IVHP38 BLACK PLASTIC



## Misc: Adapter Couplers

Series: F. FIRG12A M. BIR12  
M. FIRG12A F. BIR12

### Advantages of Adapters

- Provides compatibility between old and new equipment
- Avoids changing mismatched couplers
- Bi-directional flow



F. FIRG12A M. BIR12

STUCCHI SERIES	NOMINAL SIZE	ISO SIZE	MAX WORKING PRESSURE	MAX WORKING PRESSURE
VEP	inch	mm	bar	psi
F. FIRG12A M. BIR12	1/2	12.5	250	3750
M. FIRG12A F. BIR12	1/2	12.5	250	3750

### Adapter Couplers Flat Face/ISO A | 8036-Adapter

DESCRIPTION	ORDER CODE	PART INSCRIPTION
1/2 FEMALE FLAT FAC /1/2 MALE ISO A	803622000	F. FIRG12A M. BIR12
1/2 MALE FLAT FACE/1/2 FEMALE ISO A	803622001	M. FIRG12A F. BIR12



M. FIRG12A F. BIR12

# IRH Series European Poppet Interchange



## Misc: IRH Series

Series: IRH

**Interchange:** Tema "T"

Applications include chemical industries, industrial plants, material handling, and mobile machinery. Standard poppet and pressure eliminator poppet available.

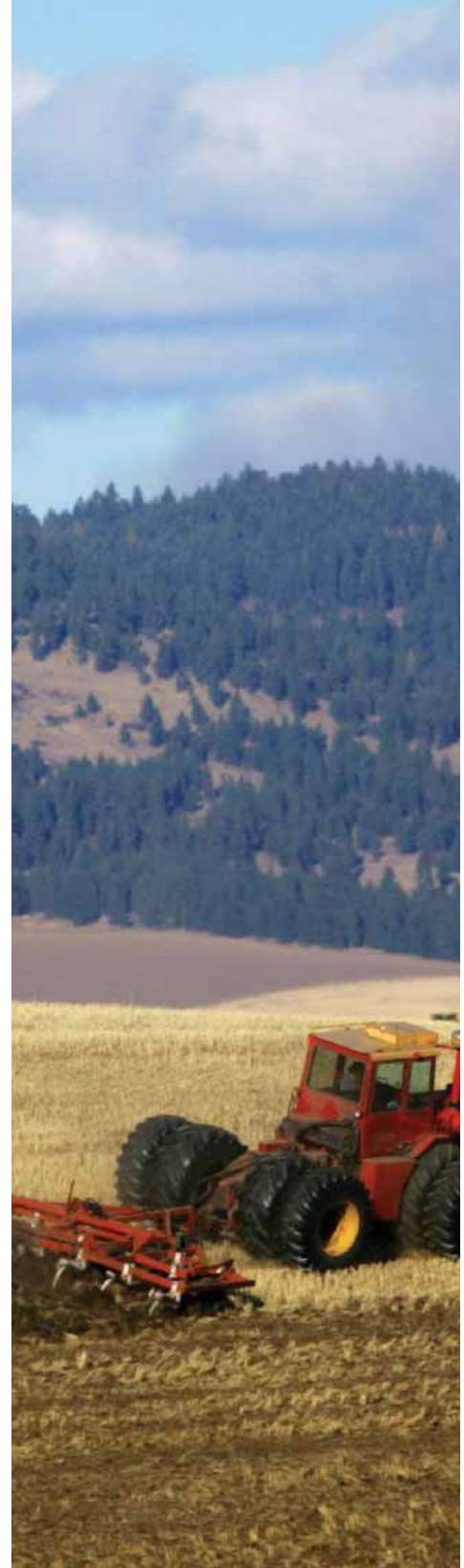



DESCRIPTION	NOMINAL SIZE	ISO SIZE	MAX. OPERATING PRESSURE COUPLED		BURST PRESSURE					
					COUPLED		MALE		FEMALE	
					MPa	psi	MPa	psi	MPa	psi
IRH14	1/4	6.3	60	8702	180	26106	120	17404	120	17404
IRH38	3/8	10.0	46.5	6744	130	18854	110	15954	110	15954
IRH12	1/2	12.5	40	5801	110	15954	100	14503	100	14503
IRH34	3/4	20.0	27	3916	100	14503	80	11603	80	11603
IRH100	1	25.0	27	3916	90	13053	80	11603	80	11603

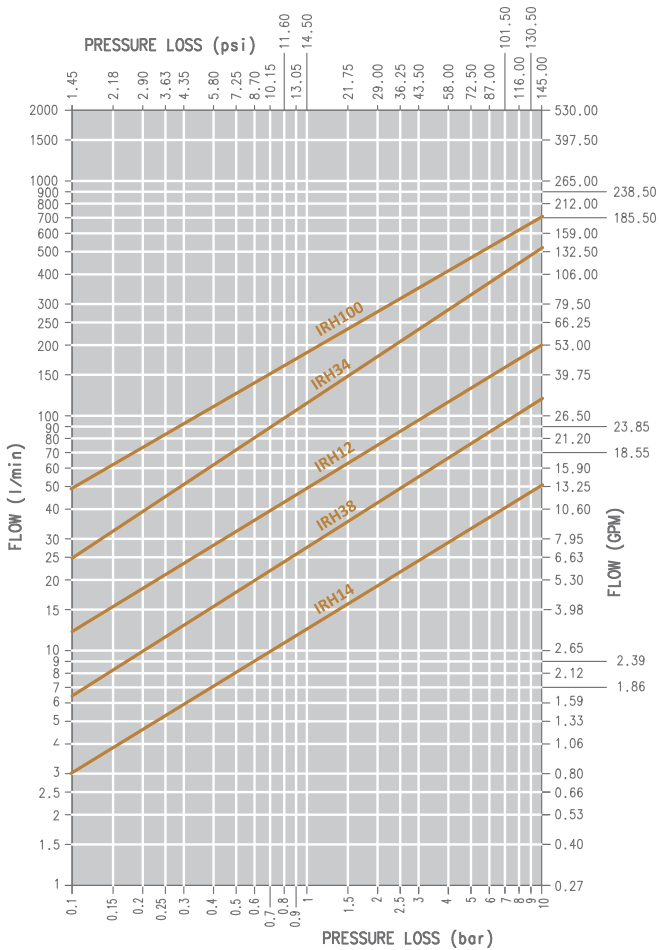

# IRH Series European Poppet Interchange

## Misc: IRH Series Size Diagram

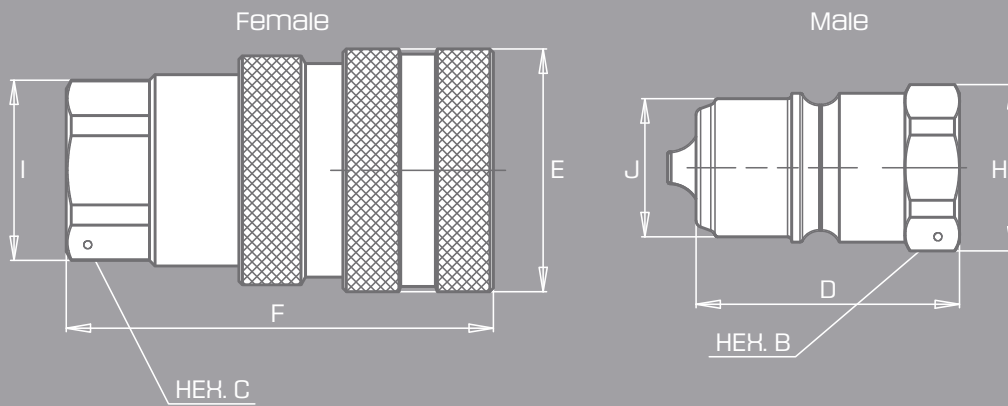

DESCRIPTION	BODY SIZE	A	B	C	D	E	F	G	H	I	J	WEIGHT	
												MALE	FEMALE
IRH14 NPTF	6.3	1/4	19	21	48.2	26	60	81.7	21	23	11.95	51	145
IRH38 NPTF	10	3/8	22	24	38	35	61.6	76.4	24	26	19.9	57	222
IRH12 NPTF	12.5	1/2	27	30	42.5	41	67.6	85.2	29	33	24.7	99	327
IRH34 NPTF	20	3/4	36	38	47	52	76.2	94.6	39	41.6	32.7	189	575
IRH100 NPTF	25	1	45	45	56.5	62	92	113.4	48	48	40.9	352	971





**IRH NPT and BSP Thread**\_Tema "T" Series | European Interchange

PART	BODY SIZE	PORT SIZE	THREAD TYPE	ORDER CODE	PART DESCRIPTION
<b>IRH NPT THREAD</b>					
COUPLER	1/4	1/4	NPT	807902000	F. IRH 14 NPTF
NIPPLE	1/4	1/4	NPT	807902001	M. IRH 14 NPTF
COUPLER	3/8	3/8	NPT	807902002	F. IRH 38 NPTF
NIPPLE	3/8	3/8	NPT	807902003	M. IRH 38 NPTF
COUPLER	1/2	1/2	NPT	807902004	F. IRH 12 NPTF
NIPPLE	1/2	1/2	NPT	807902005	M. IRH 12 NPTF
COUPLER	3/4	3/4	NPT	807902006	F. IRH 34 NPTF
NIPPLE	3/4	3/4	NPT	807902007	M. IRH 34 NPTF
COUPLER	1	1	NPT	807902008	F. IRH 100 NPTF
NIPPLE	1	1	NPT	807902009	M. IRH 100 NPTF
<b>IRH NPT THREAD - CONNECT UNDER PRESSURE VALVE</b>					
COUPLER	3/8	3/8	NPT	807902010	F. IRH 38PC NPTF
NIPPLE	3/8	3/8	NPT	807902011	M. IRH 38PC NPTF
COUPLER	1/2	1/2	NPT	807902012	F. IRH 12PC NPTF
NIPPLE	1/2	1/2	NPT	807902013	M. IRH 12PC NPTF
COUPLER	3/4	3/4	NPT	807902014	F. IRH 34PC NPTF
NIPPLE	3/4	3/4	NPT	807902015	M. IRH 34PC NPTF
COUPLER	1	1	NPT	807902016	F. IRH 100PC NPTF
NIPPLE	1	1	NPT	807902017	M. IRH 100PC NPTF
<b>IRH BSP THREAD</b>					
COUPLER	3/4	3/4	BSP	807900006	F. IRH 34 BSP
NIPPLE	3/4	3/4	BSP	807900007	M. IRH 34 BSP
COUPLER	1	1	BSP	807900008	F. IRH 100 BSP
NIPPLE	1	1	BSP	807900009	M. IRH 100 BSP
<b>IRH BSP THREAD - CONNECT UNDER PRESSURE VALVE</b>					
COUPLER	3/4	3/4	BSP	807900014	F. IRH 34PC BSP
NIPPLE	3/4	3/4	BSP	807900015	M. IRH 34PC BSP



COUPLER



NIPPLE



NIPPLE-PC

# VD Series Screw Poppet Interchange



COMING SOON



## Stucchi: VD Series

### Series: VD European Screw Coupler

Available from size 1/4 to 1 1/4 inch to cover the various fields of hydraulic applications. The series VD couplings are mostly used in mobile crane, vibratory hammer, oil patch and industrial plant applications.

Screw-on system ensures connection with some residual pressure

- Friction ring to prevent accidental disconnection
- Hardened valve bodies for impulse applications
- Interchangeable with the German market
- O-ring connected marker is highly visible during connection and helps to keep containments out of the threads while connected

### Overview

Due to their rugged design, VD series couplings are particularly well suited for heavy-duty service conditions making them one of the most popular designs in Europe. The VD coupler is a durable product using a poppet style valve for the sealing mechanism and threads as the mechanical connection. Highly versatile design is ideally suited for hydraulic systems experiencing pressure spikes or impulses.

### Technical Characteristics

- Coupling body: zinc plated steel
- Nipple is zinc plated hardened steel
- Seals: Nitrile
- Anti-extrusion rings are Teflon
- Internal components purposely designed to reduce turbulence
- Wide range of ports on request
- Metal shoulder to protect the o-ring seal on female coupling
- Screw-on system ensures connection under residual pressure



DESCRIPTION	SIZE	MAX. WORKING PRESSURE CONNECTED	
		MPa	psi
VD14	1/4	45	6527
VD38	3/8	45	6527
VD12	1/2	40	5801
VD34	3/4	40	5801
VD100	1	30	4351
VD114	1 1/4	30	4351

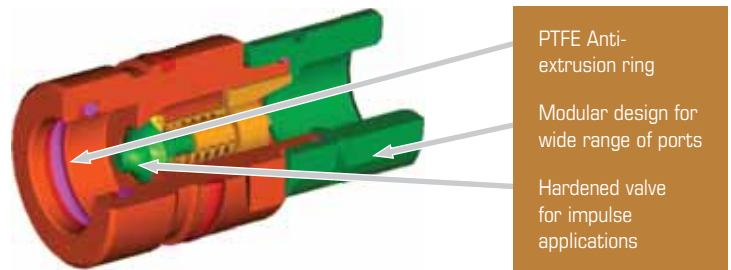
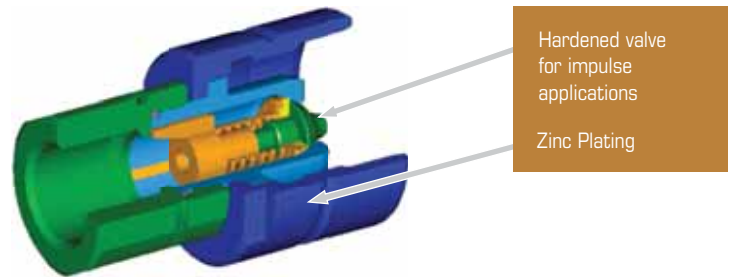
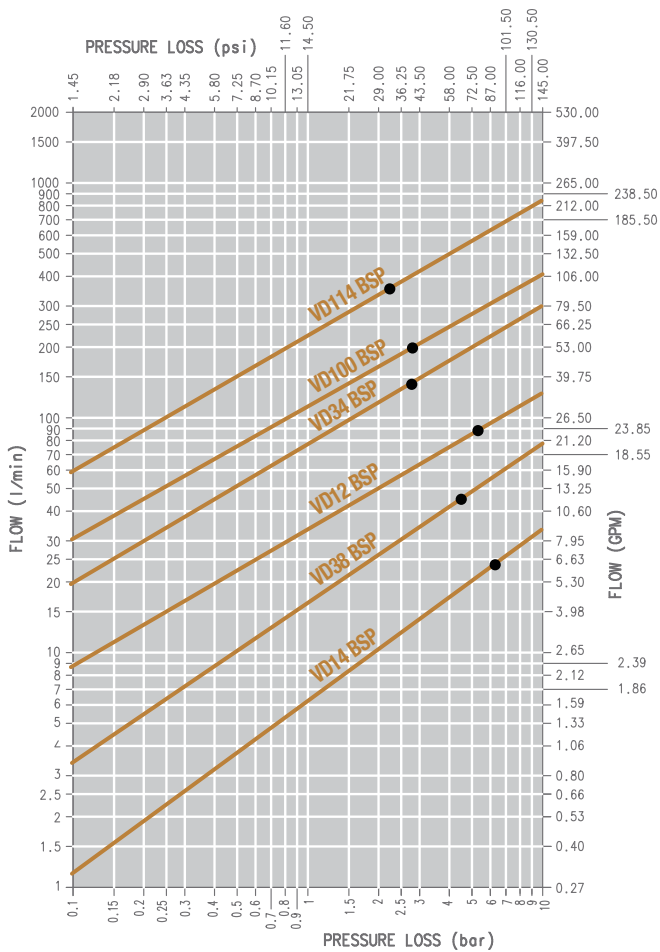

# VD Series Screw Poppet Interchange

## Misc: VD Series Size Diagram

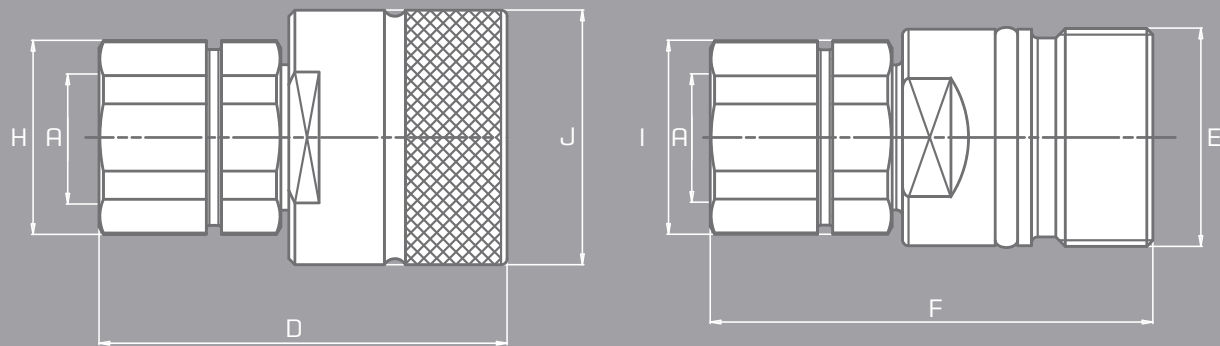

DESCRIPTION	BODY SIZE	A	DIMENSION	D	E	F	H	I	J
VD38	3/8	3/8	mm	60.7	28	63.3	24	24	34
			inch	2.39	1.1	2.49	0.94	0.94	1.34
VD12	1/2	1/2	mm	67.3	36	73	32	32	42
			inch	2.65	1.42	2.87	1.26	1.26	1.65
VD34	3/4	3/4	mm	72.5	42	82	40	40	48
			inch	2.85	1.65	3.23	1.57	1.57	1.89
VD100	1	1	mm	82.5	48	99	45	45	55
			inch	3.25	1.89	3.9	1.77	1.77	2.17



**VD DIN Thread\_SCHOTT (DIN Bulkhead) | Screw Poppet Interchange**

PART	BODY SIZE	THREAD TYPE	PORT SERIES	TUBE OD	THREAD SIZE	ORDER CODE	DESCRIPTION
<b>VD DIN THREAD</b>							
COUPLER	1/2	DIN	FEMALE	22	M22X1.5	809512000	INN. F. VD12 M22X1.5
NIPPLE	1/2	DIN	FEMALE	22	M22X1.5	809512001	INN. M. VD12 M22X1.5
COUPLER	1/2	DIN	L	12	M 18X1.5	809508000	INN. F. VD12 L12
NIPPLE	1/2	DIN	L	12	M 18X1.5	809508001	INN. M. VD12 L12
COUPLER	1/2	DIN	L	15	M 22X1.5	809508004	INN. F. VD12 L15
NIPPLE	1/2	DIN	L	15	M 22X1.5	809508005	INN. M. VD12 L15
COUPLER	1/2	DIN	L	18	M 26X1.5	809508008	INN. F. VD12 L18
NIPPLE	1/2	DIN	L	18	M 26X1.5	809508009	INN. M. VD12 L18
COUPLER	1/2	DIN	L	12	M 18X1.5 SCHOTT	809510000	INN. F. VD12 L12 SCHOTT
NIPPLE	1/2	DIN	L	12	M 18X1.5 SCHOTT	809510001	INN. M. VD12 L12 SCHOTT
COUPLER	1/2	DIN	L	15	M 22X1.5 SCHOTT	809510004	INN. F. VD12 L15 SCHOTT
NIPPLE	1/2	DIN	L	15	M 22X1.5 SCHOTT	809510005	INN. M. VD12 L15 SCHOTT
COUPLER	3/4	DIN	S	16	M 24X1.5	809509014	INN. F. VD34 S16
NIPPLE	3/4	DIN	S	16	M 24X1.5	809509015	INN. M. VD34 S16
COUPLER	3/4	DIN	S	16	M 24X1.5 SCHOTT	809511014	INN. F. VD34 S16 SCHOTT
COUPLER	3/4	DIN	S	20	M 30X1.5 SCHOTT	809511016	INN. F. VD34 S20 SCHOTT
NIPPLE	3/4	DIN	S	20	M 30X1.5 SCHOTT	809511017	INN. M. VD34 S20 SCHOTT
COUPLER	3/4	DIN	FEMALE	22	M 22X1.5	809512002	INN. F. VD34 M22X1.5
NIPPLE	3/4	DIN	FEMALE	22	M 22X1.5	809512003	INN. M. VD34 M22X1.5
COUPLER	1	DIN	S	20	M 30X2	809509018	INN. F. VD100 S20
NIPPLE	1	DIN	S	20	M 30X2	809509019	INN. M. VD100 S20
COUPLER	1	DIN	S	25	M 36X2	809509020	INN. F. VD100 S25
NIPPLE	1	DIN	S	25	M 36X2	809509021	INN. M. VD100 S25
COUPLER	1	DIN	S	30	M 42X2	809509022	INN. F. VD100 S30
NIPPLE	1	DIN	S	30	M 42X2	809509023	INN. M. VD100 S30
COUPLER	1	DIN	S	20	M 30X2 SCHOTT	809511018	INN. F. VD100 S20 SCHOTT
NIPPLE	1	DIN	S	20	M 30X2 SCHOTT	809511019	INN. M. VD100 S20 SCHOTT
COUPLER	1	DIN	S	25	M 36X2 SCHOTT	809511020	INN. F. VD100 S25 SCHOTT
NIPPLE	1	DIN	S	25	M 36X2 SCHOTT	809511021	INN. M. VD100 S25 SCHOTT
COUPLER	1	DIN	S	30	M 42X2 SCHOTT	809511022	INN. F. VD100 S30 SCHOTT
NIPPLE	1	DIN	S	30	M 42X2 SCHOTT	809511023	INN. M. VD100 S30 SCHOTT
COUPLER	1	DIN	S	38	M 52X2 SCHOTT	809511024	INN. F. VD100 S38 SCHOTT
COUPLER	1 1/4	DIN	S	38	M 52X2	809509028	INN. F. VD114 S38
NIPPLE	1 1/4	DIN	S	38	M 52X2	809509029	INN. M. VD114 S38
COUPLER	1 1/4	DIN	S	38	M 52X2 SCHOTT	809511028	INN. F. VD114 S38 SCHOTT
NIPPLE	1 1/4	DIN	S	38	M 52X2 SCHOTT	809511029	INN. M. VD114 S38 SCHOTT



COUPLER



NIPPLE

# VD Series Screw Poppet Interchange

## VD BSP and NPT Thread\_Screw Poppet Interchange



COUPLER



NIPPLE

PART	BODY SIZE	THREAD TYPE	THREAD SIZE	PORT THREAD	ORDER CODE	DESCRIPTION
<b>VD BSP THREAD</b>						
COUPLER	3/8	BSP	1/4	1/4-9	809500008	INN. F. VD38 1/4 BSP
NIPPLE	3/8	BSP	1/4	1/ -9	809500009	INN. M. VD38 1/4 BSP
COUPLER	3/8	BSP	3/8	3/8-19	809500010	INN. F. VD38 3/8 BSP
NIPPLE	3/8	BSP	3/8	3/8-19	809500011	INN.M VD38 3/8 BSP
COUPLER	3/8	BSP	3/8	3/8-19	809500012	F. VD38 3/8 BSP EST DIN3852-2-A
NIPPLE	3/8	BSP	3/8	3/8-19	809500013	M. VD38 3/8 BSP EST DIN3852-2-A
COUPLER	1/2	BSP	3/8	3/8-19	809500000	INN. F. VD12 3/8 BSP
NIPPLE	1/2	BSP	3/8	3/8-19	809500001	INN. M. VD12 3/8 BSP
COUPLER	1/2	BSP	1/2	1/2-4	809500002	INN. F. VD12 1/2 BSP
NIPPLE	1/2	BSP	1/2	1/2-4	809500003	INN. M. VD12 1/2 BSP
COUPLER	1/2	BSP	1/2	1/2-4	809500004	INN. F. VD12 1/2 BSP EST
NIPPLE	1/2	BSP	1/2	1/2-4	809500005	INN. M. VD12 1/2 BSP EST
COUPLER	3/4	BSP	1/2	1/2-4	809500014	INN. F. VD34 1/2 BSP
NIPPLE	3/4	BSP	1/2	1/2-4	809500015	INN. M. VD34 1/2 BSP
COUPLER	3/4	BSP	3/4	3/4-14	809500016	INN. F. VD34 3/4 BSP
NIPPLE	3/4	BSP	3/4	3/4-14	809500017	INN. M. VD34 3/4 BSP
COUPLER	1	BSP	3/4	3/4-14	809500018	INN. F. VD100 3/4 BSP
NIPPLE	1	BSP	3/4	3/4-14	809500019	INN. M. VD100 3/4 BSP
COUPLER	1	BSP	1	1-11	809500020	INN. F. VD100 1 BSP
NIPPLE	1	BSP	1	1-11	809500021	INN. M. VD100 1 BSP
COUPLER	1 1/4	BSP	1 1/4	1 1/4-11	809500022	INN. F. VD114 1-1/4 BSP
NIPPLE	1 1/4	BSP	1 1/4	1 1/4-11	809500023	INN. M. VD114 1-1/4 BSP
COUPLER	1 1/4	BSP	1-1/2	1 1/2-11	809500024	INN. F. VD114 1-1/2 BSP
NIPPLE	1 1/4	BSP	1-1/2	1 1/2-11	809500025	INN. M. VD114 1-1/2 BSP
<b>VD NPT THREAD</b>						
COUPLER	3/8	NPT	1/4	1/4-18	809501008	INN. F. VD38 1/4 NPT
NIPPLE	3/8	NPT	1/4	1/4-18	809501009	INN. M. VD38 1/4 NPT
COUPLER	3/8	NPT	3/8	3/8-18	809501010	INN. F. VD38 3/8 NPT
NIPPLE	3/8	NPT	3/8	3/8-18	809501011	INN. M. VD38 3/8 NPT
COUPLER	1/2	NPT	3/8	3/8-18	809501000	INN. F. VD12 3/8 NPT
NIPPLE	1/2	NPT	3/8	3/8-18	809501001	INN. M. VD12 3/8 NPT
COUPLER	1/2	NPT	1/2	1/2-14	809501002	INN. F. VD12 1/2 NPT
NIPPLE	1/2	NPT	1/2	1/2-14	809501003	INN. M. VD12 1/2 NPT
COUPLER	3/4	NPT	1/2	1/2-14	809501014	INN. F. VD34 1/2 NPT
NIPPLE	3/4	NPT	1/2	1/2-14	809501015	INN. M. VD34 1/2 NPT
COUPLER	3/4	NPT	3/4	3/4-14	809501016	INN. F. VD34 3/4 NPT
NIPPLE	3/4	NPT	3/4	3/4-14	809501017	INN. M. VD34 3/4 NPT
COUPLER	1	NPT	3/4	3/4-14	809501018	INN. F. VD100 3/4 NPT
NIPPLE	1	NPT	3/4	3/4-14	809501019	INN. M. VD100 3/4 NPT
COUPLER	1	NPT	1	1-11 1/2	809501020	INN. F. VD100 1 NPT
NIPPLE	1	NPT	1	1-11 1/2	809501021	INN. M. VD100 1 NPT
COUPLER	1 1/4	NPT	1 1/4	1 1/4-11 1/2	809501022	INN. F. VD114 1-1/4 NPT
NIPPLE	1 1/4	NPT	1 1/4	1 1/4-11 1/2	809501023	INN. M. VD114 1-1/4 NPT
COUPLER	1 1/4	NPT	1-1/2	1 1/2-11 1/2	809501024	INN. F. VD114 1-1/2 NPT
NIPPLE	1 1/4	NPT	1-1/2	1 1/2-11 1/2	809501025	INN. M. VD114 1-1/2 NPT



# VR Series European Screw Coupler



COMING SOON



## Stucchi: VR Series

### Series: VR German Screw Coupler

Available in four sizes 3/8, 1/2, 1, 1 1/4 inches, covering the various fields of hydraulic applications. The series VR couplings are mostly used in mobile cranes, trucks and industrial plant applications.

Screw-on system ensures connection with some residual pressure

- Friction ring to prevent accidental disconnection
- Low leakage screw coupling
- Interchangeable with the German market
- Wide range of port options

#### Overview

Due to their rugged design, VR series couplings are particularly well suited for heavy-duty service conditions. The VR coupler is a durable product using a low leakage style valve for the sealing mechanism and threads as the mechanical connection.

#### Technical Characteristics

- Coupling body:  
zinc plated steel
- Nipple is zinc plated  
hardened steel
- Seals: Nitrile
- Anti-extrusion rings  
are Teflon
- Internal components  
purposely designed to  
reduce turbulence
- Wide range of ports on  
request and various seals
- Screw-on system  
ensures connection under  
residual pressure

DESCRIPTION	SIZE	MAX. WORKING PRESSURE CONNECTED	
		MPa	psi
VR38	3/8	40	5801
VR12	1/2	30	4351
VR100	1	32	4641
VR114	1 1/4	42	6091

# VLS Series Heavy Duty Screw Coupler



COMING SOON



## VLS Series

### Series: VLS Heavy Duty Screw Coupler

Available in two sizes: 1/2 and 1 inch. The series VLS couplings are mostly used on off highway applications and are a very rugged design making them particularly well suited for use in construction equipment under extreme conditions.

#### Overview

VLS series couplings are particularly well suited for heavy-duty service conditions. The VLS coupler is a durable product using heavy duty poppet style valves for the sealing mechanism and threads as the mechanical connection.

#### Technical Characteristics

- Coupling body:  
zinc plated steel
- Nipple is zinc plated  
hardened steel
- Seals: Nitrile
- Anti-extrusion rings  
are Teflon
- Internal components  
designed to reduce  
turbulence and handle  
impulse applications
- Screw-on system  
ensures connection  
under residual pressure

DESCRIPTION	SIZE	MAX. WORKING PRESSURE CONNECTED	
		MPa	psi
VLS12	1/2	46.5	6744
VLS100	1	46.5	6744



## Overview

- VU series are used in any type of hydraulic circuit
- Alternative uses: as pressure sequence valve by adjusting the internal spring loading to the required cracking point, according to the valve size

## Instructions for Use

The VU series must be assembled in the circuit so that the direction of the flow corresponds to the direction of the arrow marked on the valve.

## Check Valves: VU Series

### Series: VU

The Stucchi check valve design is safe, compact and suitable to any hydraulic application using non-corrosive liquids. The VU size-range includes two different standard openings at 5 to 65 psi.

- Material: steel with black phosphate
- Closing spring in C72 material
- Standard Crack 5 psi and 65 psi
- Standard SAE and NPT threads
- Various crack pressures optional
- Central exhausting hole option
- Zinc plating available upon request



# VU Series Check Valves

DESCRIPTION	SIZE	MAX SUGGESTED FLOW		MAX OPERATING PRESSURE		BURST PRESSURE	
	Inch	l/min	GPM	MPa	psi	MPa	psi
VU18	1/8	6	1.59	40	5800	160	23200
VU14	1/4	24	6.36	35	5075	140	20300
VU38	3/8	46	12.19	35	5075	140	20300
VU12	1/2	90	23.85	30	4350	120	17400
VU34	3/4	148	39.22	30	4350	120	17400
VU100	1	200	53	30	4350	120	17400
VU114	1 1/4	378	100.17	25	3625	100	14500
VU112	1 1/2	600	159	25	3625	100	14500
VU200	2	1000	265	15	2175	45	6525

TEMPERATURE RANGE: FROM -20 °C (-4 °F) TO 120 °C (248 °F)

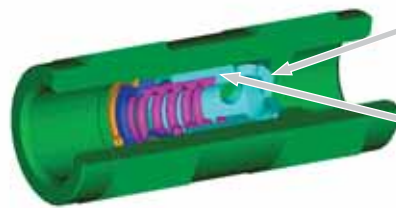
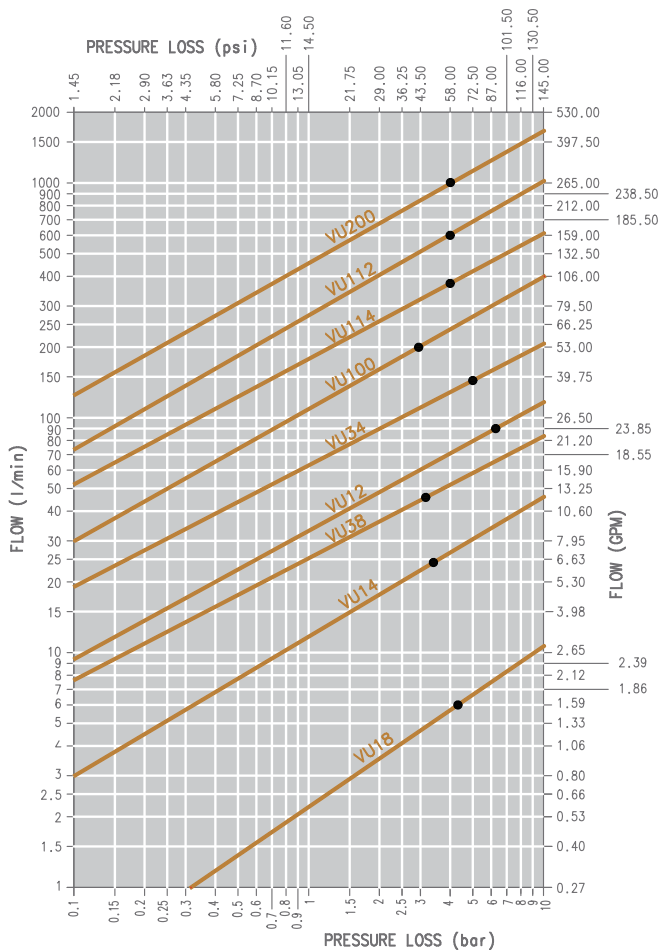

Metal to metal sealing avoids seal extrusion at high flow rates  
Sealing Piston hardened with heat treatment



## Check Valves: VU Series Size Diagram

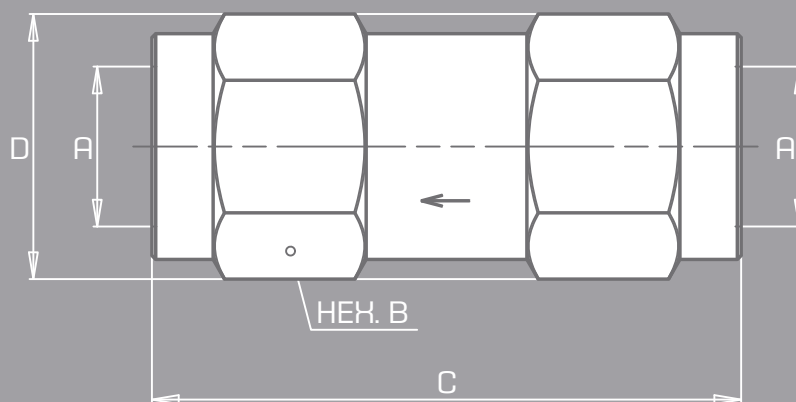

DESCRIPTION	A	B		C		D		WEIGHT	
		mm	inch	mm	inch	mm	inch	Kg	lb
VU18	1/8	14.0	0.55	44.0	1.73	16.2	0.64	0.038	0.08
VU14	1/4	19.0	0.75	60.0	2.36	21.9	0.86	0.090	0.20
VU38	3/8	24.0	0.94	70.0	2.76	27.7	1.09	0.185	0.41
VU12	1/2	30.0	1.18	77.0	3.03	34.6	1.36	0.303	0.67
VU34	3/4	36.0	1.42	90.0	3.54	41.6	1.64	0.499	1.10
VU100	1	45.0	1.77	106.0	4.17	52.0	2.05	0.901	1.99
VU114	1 1/4	55.0	2.17	125.0	4.92	63.5	2.50	1.513	3.34
VU112	1 1/2	65.0	2.56	140.0	5.51	75.1	2.96	2.430	5.36
VU200	2	75.0	2.95	160.0	6.30	86.6	3.41	3.130	6.90

# VU Series Check Valves



## VU NPT and SAE Thread Check Valves

CRACK POINT	BODY SIZE	PORT SIZE	THREAD TYPE	ORDER CODE BLACK OXIDE	ORDER CODE YELLOW ZINC	PART DESCRIPTION
<b>VU NPT THREAD</b>						
5 psi	1/8	1/8	NPT	810201100	810501100	VU 18 NPT 5 PSI
5 psi	1/4	1/4	NPT	810201101	810501101	VU 14 NPT 5 PSI
5 psi	3/8	3/8	NPT	810201102	810501102	VU 38 NPT 5 PSI
5 psi	1/2	1/2	NPT	810201103	810501103	VU 12 NPT 5 PSI
5 psi	3/4	3/4	NPT	810201104	810501104	VU 34 NPT 5 PSI
5 psi	1	1	NPT	810201105	810501105	VU 100 NPT 5 PSI
5 psi	1 1/4	1 1/4	NPT	810201106	810501106	VU 114 NPT 5 PSI
5 psi	1 1/2	1 1/2	NPT	810201107	810501107	VU 112 NPT 5 PSI
5 psi	2	2	NPT	810201108	810501108	VU 200 NPT 5 PSI
5 psi	3/4	3/4	NPT	810201109	810501109*	VU 34F 1.5 NPT 5 PSI
5 psi	1	1	NPT	810201110	810501110*	VU 100F 1.5 NPT 5 PSI
5 psi	1/2	1/2	NPT	810201112	810501112*	VU 12EI NPT 5 PSI**
65 psi	1/8	1/8	NPT	810201400	810501400	VU 18 NPT 65 PSI
65 psi	1/4	1/4	NPT	810201401	810501401	VU 14 NPT 65 PSI
65 psi	3/8	3/8	NPT	810201402	810501402	VU 38 NPT 65 PSI
65 psi	1/2	1/2	NPT	810201403	810501403	VU 12 NPT 65 PSI
65 psi	3/4	3/4	NPT	810201404	810501404	VU 34 NPT 65 PSI
65 psi	1	1	NPT	810201405	810501405	VU 100 NPT 65 PSI
65 psi	1 1/4	1 1/4	NPT	810201406	810501406	VU 114 NPT 65 PSI
65 psi	1 1/2	1 1/2	NPT	810201407	810501407	VU 112 NPT 65 PSI
65 psi	2	2	NPT	810201408	810501408	VU 200 NPT 65 PSI
<b>VU SAE THREAD</b>						
5 psi	1/4	1/4	SAE	810204100	810504100	VU 14 SAE 5 PSI
5 psi	3/8	3/8	SAE	810204101	810504101	VU 38 SAE 5 PSI
5 psi	1/2	1/2	SAE	810204102	810504102	VU 12 SAE 5 PSI
5 psi	3/4	3/4	SAE	810204103	810504103	VU 34 SAE 5 PSI
5 psi	1	1	SAE	810204104	810504104	VU 100 SAE 5 PSI
5 psi	1 1/4	1 1/4	SAE	810204105	810504105	VU 114 SAE 5 PSI
5 psi	1 1/2	1 1/2	SAE	810204106	810504106	VU 112 SAE 5 PSI
5 psi	2	2	SAE	810204107	810504107	VU 200 SAE 5 PSI
65 psi	1/4	1/4	SAE	810204400	810504400	VU 14 SAE 65 PSI
65 psi	3/8	3/8	SAE	810204401	810504401	VU 38 SAE 65 PSI
65 psi	1/2	1/2	SAE	810204402	810504402	VU 12 SAE 65 PSI
65 psi	3/4	3/4	SAE	810204403	810504403	VU 34 SAE 65 PSI
65 psi	1	1	SAE	810204404	810504404	VU 100 SAE 65 PSI
65 psi	1 1/4	1 1/4	SAE	810204405	810504405	VU 114 SAE 65 PSI
65 psi	1 1/2	1 1/2	SAE	810204406	810504406	VU 112 SAE 65 PSI
65 psi	2	2	SAE	810204407	810504407	VU 200 SAE 65 PSI

\*AVAILABLE UPON SPECIAL REQUEST.

\*\*FEMALE X MALE NPT



### VU NPT Thread Check Valves

CRACK POINT	BODY SIZE	PORT SIZE	THREAD TYPE	ORDER CODE:	PART DESCRIPTION
<b>VU NPT THREAD</b>					
14 psi	1/4	1/4	NPT	810201200	VU 14 NPT 14 PSI
14 psi	1/2	1/2	NPT	810201201	VU 12 NPT 14 PSI
14 psi	3/4	3/4	NPT	810201202	VU 34 NPT 14 PSI
14 psi	1	1	NPT	810201203	VU 100 NPT 14 PSI
14 psi	1 1/4	1 1/4	NPT	810201204	VU 114 NPT 14 PSI
14 psi	1 1/2	1 1/2	NPT	810201205	VU 112 NPT 14 PSI
21 psi	1	1	NPT	810201300	VU 100 NPT 21 PSI
57 psi	1/2	1/2	NPT	810201409	VU 12 NPT 57 PSI
115 psi	1/2	1/2	NPT	810201600	VU 12 NPT 115 PSI
115 psi	3/4	3/4	NPT	810201601	VU 34 NPT 115 PSI
145 psi	1	1	NPT	810201602	VU 100 NPT 145 PSI
215 psi	1/4	1/4	NPT	810201700	VU 14 NPT 215 PSI
290 psi	1/2	1/2	NPT	810201701	VU 12 NPT 290 PSI



### VUS NPT Thread Soft Seat Check Valves

CRACK POINT	BODY SIZE	PORT SIZE	THREAD TYPE	ORDER CODE:	PART DESCRIPTION
<b>VUS NPT THREAD</b>					
5 psi	3/4	3/4	NPT	810701100	VUS34 NPT 5 PSI SOFT SEAT
50 psi	3/4	1	NPT	810201400	VUS100 NPT 50 PSI SOFT SEAT





# MP Series Hydraulic Multi-Coupling Plate



## Multi-Coupling Plate

The multi-coupling plate is a tool allowing the simultaneous couple and uncouple of a certain number of hydraulic and/or electrical lines. From a minimum of two to a maximum of ten lines can be simultaneously connected by a single, simple movement requiring very little force.

The energy lines can all have the same nominal diameter or each line can be different from the others according to the application. A special multi-coupling plate version provided with electrical connector can be supplied.

- Connects with residual pressure
- Mechanical connection eliminates brinelling effect
- Safety lock prevents unwanted disconnection
- Simple to use with a single movement applied by one arm only
- Ease of maintenance or replacement of quick couplings
- Cap and parking station available

### Overview

- Front end loaders
- Harvesting equipment
- Construction machinery
- Refrigeration
- Snow removal equipment
- Energy sector
- Any application requiring connection under residual pressure of multiple couplings

### Features

- Connect up to 25 MPa/ 3625 psi residual pressure
- Auto safety lock when connected
- Single hand operation
- Compact design
- Flat face couplers eliminate leakage
- Flat face couplers reduce contamination
- Guide mechanism eliminates cross connecting circuits



**< Cover Plate**

Heavy Duty Metal  
Dust Cover for Fixed Half



**< Mobile Half**

Flat Face Couplers: Easy to Clean, No Leakage

Guide Pins Eliminate Risk of Misaligned Circuit



**< Electrical Connector Option**

Corrosion Resistant Materials  
Patented Design

**Parking Station >**



**Cover Plate in Parking Station >**



**Mobile Half in Parking Station >**

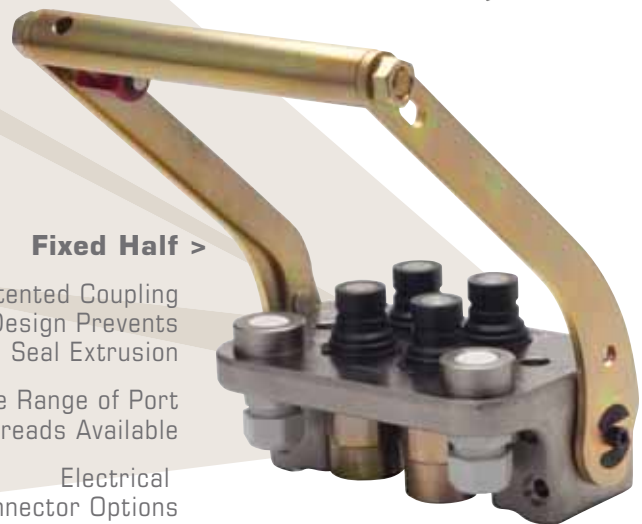

**Fixed Half >**

Patented Coupling Design Prevents Seal Extrusion

Wide Range of Port Threads Available

Electrical Connector Options

**The Stucchi Solution to Connecting Multiple Couplings Simultaneously**

1. Ergonomic lever for easy connect/disconnect with residual pressure
2. Patented coupling design to connect/disconnect multiple couplings with high residual pressure
3. Flat face couplers eliminate environmental issue of leakage
4. No risk of misalignment with guide pin design
5. Couplers mounted with snap rings for ease of installation or replacement
6. Fixed half male couplers interchangeable with ISO 16028 style flat face coupling
7. Electrical connector option for electronic control systems
8. Easily mounted on new equipment or retrofit on pre-existing system

# Technical Characteristics & Instructions for Use

## GR Multi-Coupling Plate

### To Connect:

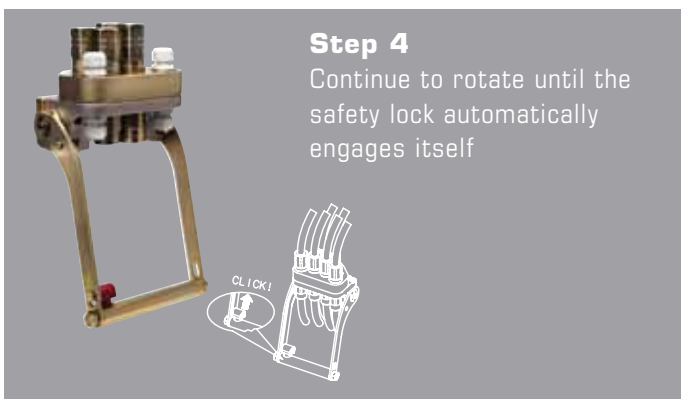
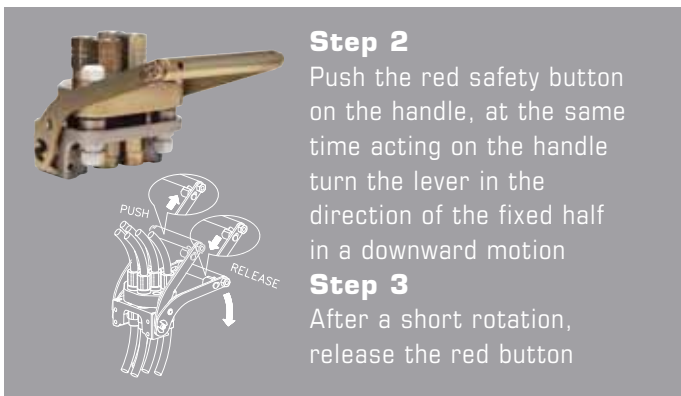
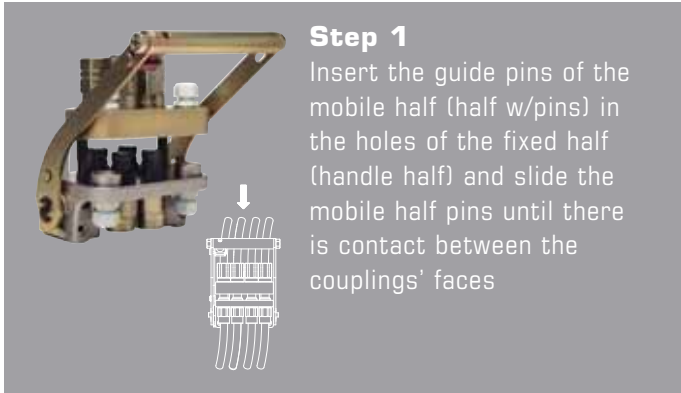

### To Disconnect:

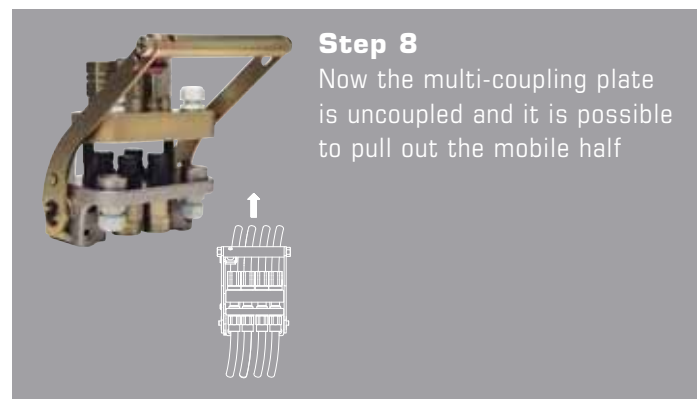
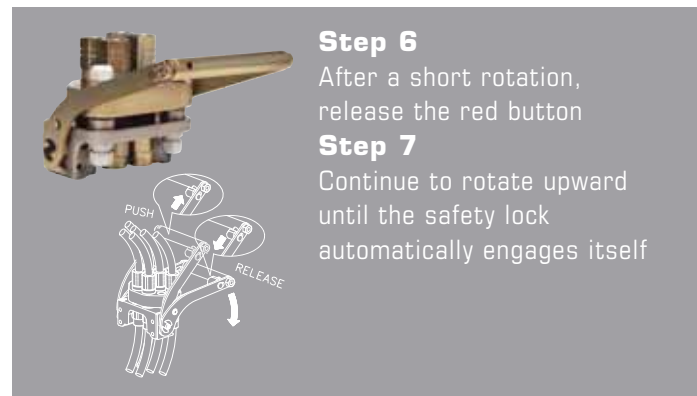
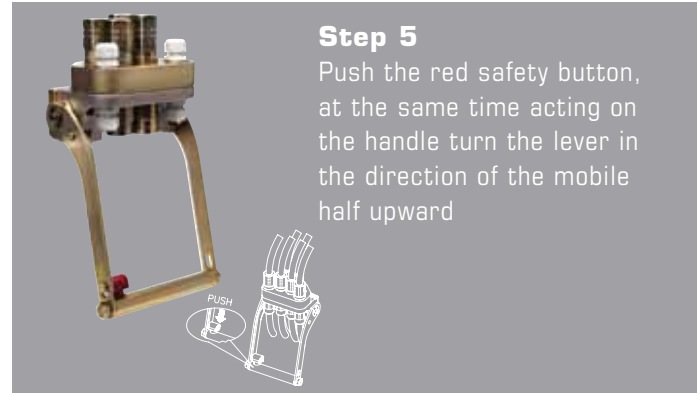

### WARNING!

- Do not force the lever without pushing the red safety button
- Do not use extensions or other tools to ease the rotating of the lever
- Do not connect the fixed half with the mobile half if dirt or other material is between them
- When the multi-coupling is disconnected, it is suggested to use the dust cover for the fixed half and the parking station for the mobile half

# Order Code Structure GR Multi-Coupling Plate



ORDER CODE STRUCTURE						
43	04	08	08	04	C	27
SERIES NUMBER	NUMBER OF COUPLINGS	SIZE OF COUPLER	PORT SIZE	THREAD	SUFFIX	OPTIONAL NUMBER OF ELECTRICAL CONNECTIONS
<b>31</b> = GRB4 <b>32</b> = GRI4 <b>33</b> = GRT6 <b>41</b> = GRP6 <b>42</b> = GRM6 <b>43</b> = GRU6 <b>44</b> = GR5AA	<b>01</b> # OF COUPLINGS <b>02</b> # OF COUPLINGS <b>03</b> # OF COUPLINGS ETC.	<b>04</b> = 1/4 <b>06</b> = 3/8 <b>08</b> = 1/2 <b>12</b> = 3/4 <b>16</b> = 1 <b>20</b> = 1 1/4	<b>04</b> = 1/4 <b>06</b> = 3/8 <b>08</b> = 1/2 <b>12</b> = 3/4 <b>16</b> = 1 <b>20</b> = 1 1/4	<b>01</b> = NPT <b>04</b> = SAE	<b>FH</b> = FIX HALF <b>MH</b> = MOBILE HALF <b>C</b> = COMPLETE	<b>17</b> 1 ELECTRICAL CONNECTION Z PRONGS <b>27</b> 2 ELECTRICAL CONNECTION Z PRONGS



SERIES ORDER CODE PREFIX	COUPLER CODE # AND COUPLER SIZE MULTI-COUPLER PLATE SERIES MULTIPLE SIZE COUPLER	FAP 9 3/8	FAP 13 1/2	FAP 15 3/4	FAP 17 1	FAP 21 1 1/4
31	GRB4	2	2			
41	GRP6	1	1	1	2	
32	GRI4	2		1	1	
42	GRM6	2		2	2	
35	GRC6	3	1	1	1	
45	GRD5	3			1	1
33	GRT6	4	2			
43	GRU6	2	2		1	1
34	GRZ5		2	2		1
47	GR6AB		4		2	
51	GR5AA		2		3	
45	GRI4TB	2		2		
46	GRK3	1				2
48	GR6LL		2		4	
47	GRM6AL	2		4		
54	GRM6MC	2	2	2		
45	GRI4SB	2	1	1		
39	GR5-15			5		
33	GR6-9	6				
43	GR6-13		6			
34	GR10-9	10				
44	GR10-13		10			
56	GR7AA	4	1		2	
57	GR7AB	4	3			
58	GR8AA	7			1	

The above list consists of the most popular stock items. Standard plates offer a variety of hydraulic coupler and electrical connector combinations too broad to list in this brochure. Use the Stucchi ordering code system to create a coupling plate configuration for your application or contact a Stucchi representative to discuss your application and a solution.

**Notes:** Plate capacities listed are the maximum number of couplers per plate. All plates can be made with fewer couplers. Electrical connectors can be added to any plates using 3/8 or 1/2 inch port spaces. Consult Stucchi USA for specific applications.

# Technical Characteristics & Instructions for Use

## DP Multi-Coupling Plate

### To Connect:

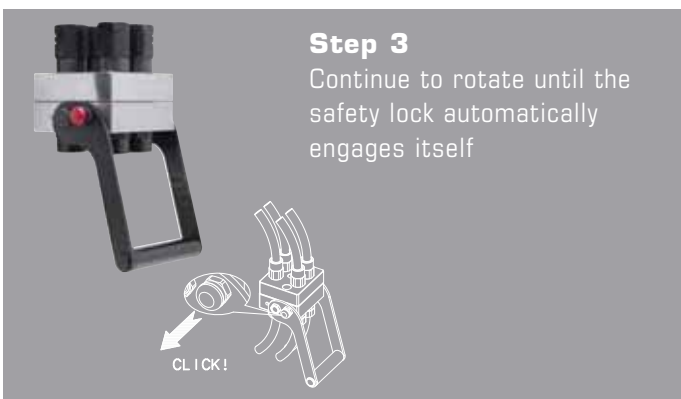
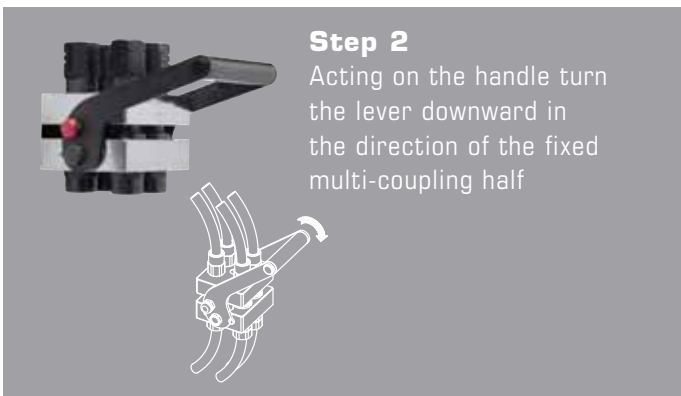
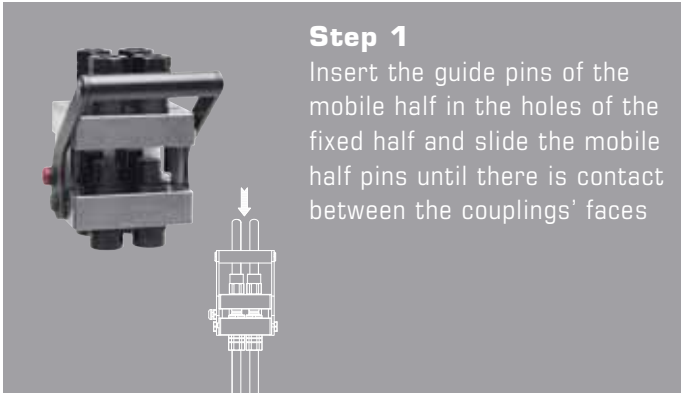

### To Disconnect:

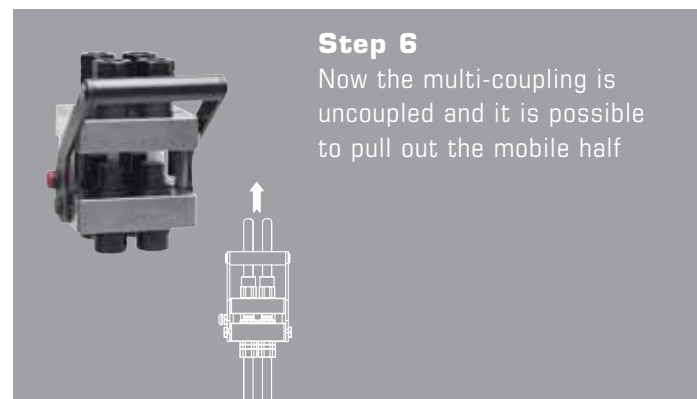
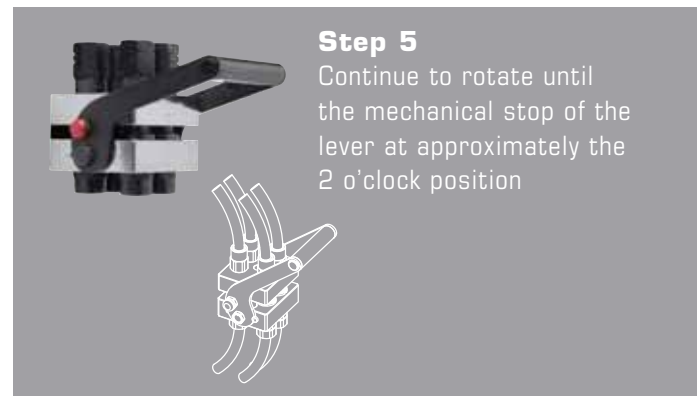
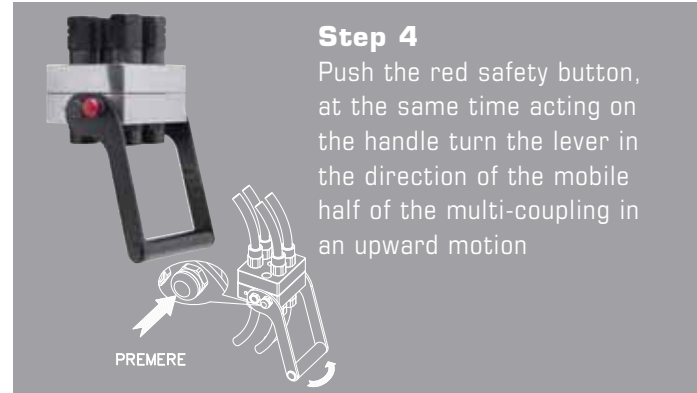

### WARNING!

- Do not force the lever without pushing the red safety button
- Do not use extensions or other tools to ease the rotating of the lever
- Do not connect the fixed half with the mobile half if dirt or other material is between them
- When the multi-coupling is disconnected, it is suggested to use the dust cover for the fixed half and the parking station for the mobile half

# Order Code Structure DP Multi-Coupling Plate



ORDER CODE STRUCTURE						
42	02	08	08	01	C	27
SERIES NUMBER	NUMBER OF COUPLINGS	SIZE OF COUPLER	PORT SIZE	THREAD	SUFFIX	OPTIONAL
						NUMBER OF ELECTRICAL CONNECTIONS
<b>31</b> = DP2-9 <b>32</b> = DP4-9 <b>41</b> = DP2-13 <b>42</b> = DP4-13	<b>01</b> # OF COUPLINGS  <b>02</b> # OF COUPLINGS  <b>03</b> # OF COUPLINGS ETC.	<b>06</b> = 3/8 <b>08</b> = 1/2	<b>06</b> = 3/8 <b>08</b> = 1/2	<b>01</b> = NPT <b>04</b> = SAE	<b>FH</b> = FIX HALF <b>MH</b> = MOBILE HALF <b>C</b> = COMPLETE	<b>17</b> 1 ELECTRICAL CONNECTION Z PRONGS  <b>16</b> 1 ELECTRICAL CONNECTION 6 PRONGS  <b>27</b> 2 ELECTRICAL CONNECTION Z PRONGS



SERIES ORDER CODE PREFIX	COUPLER SIZE AND CODE NO. MULTI-COUPLER PLATE SERIES SAME SIZE COUPLER	FAP 9 3/8	FAP 13 1/2
31	DP2-9	2	0
41	DP2-13	0	2
32	DP4-9	4	0
42	DP4-13	0	4
35	DP3-9	3	0
45	DP3-13	0	3
36	DPJ-3	1	1

The above list consists of the most popular stock items. Standard plates offer a variety of hydraulic coupler and electrical connector combinations too broad to list in this brochure. Use the Stucchi ordering code system to create a coupling plate configuration for your application contact a Stucchi representative to discuss your application and a solution.

**Notes:** Plate capacities listed are the maximum number of couplers per plate. All plates can be made with fewer couplers. Electrical connectors can be added to any plates using 3/8 or 1/2 inch port spaces. Consult Stucchi USA for specific applications.

# MP Series Hydraulic Multi-Coupling Plate

DESCRIPTION	SIZE	MAX. OPERATING PRESSURE COUPLED		BURST PRESSURE						MAX. RESIDUAL PRESSURE DURING CONNECTION		SPILLAGE*
		MPa	psi	COUPLED		MALE		FEMALE		MPa	psi	
				MPa	psi	MPa	psi	MPa	psi			
<b>FAP</b>												
FAP7	1/4	42	690	126	18270	126	18270	126	18270	30	4350	0.010
FAP9	3/8	35	5075	120	17400	120	17400	100	14500	25	3625	0.012
FAP13	1/2	33	4785	120	17400	120	17400	100	14500	25	3625	0.020
FAP15	3/4	33	4785	120	17400	120	17400	100	14500	25	3625	0.110
FAP17	1	33	4785	120	17400	120	17400	100	14500	25	3625	0.032
FAP21	1 1/4	30	4350	100	14500	100	14500	80	11600	25	3625	0.035
<b>FAP Z</b>												
FAP9Z	3/8	35	5075	120	17400	120	17400	100	14500	25	3625	0.012
FAP13Z	1/2	33	4785	120	17400	120	17400	100	14500	25	3625	0.020
FAP15Z	3/4	33	4785	120	17400	120	17400	100	14500	25	3625	0.110
FAP17Z	1	33	4785	120	17400	120	17400	100	14500	25	3625	0.032
FAP21Z	1 1/4	30	4350	100	14500	100	14500	80	11600	25	3625	0.035

\* SPILLAGE IS AN INDICATIVE VALUE OF THE FLUID LOSS PER COUPLE-UNCUPLE CYCLE

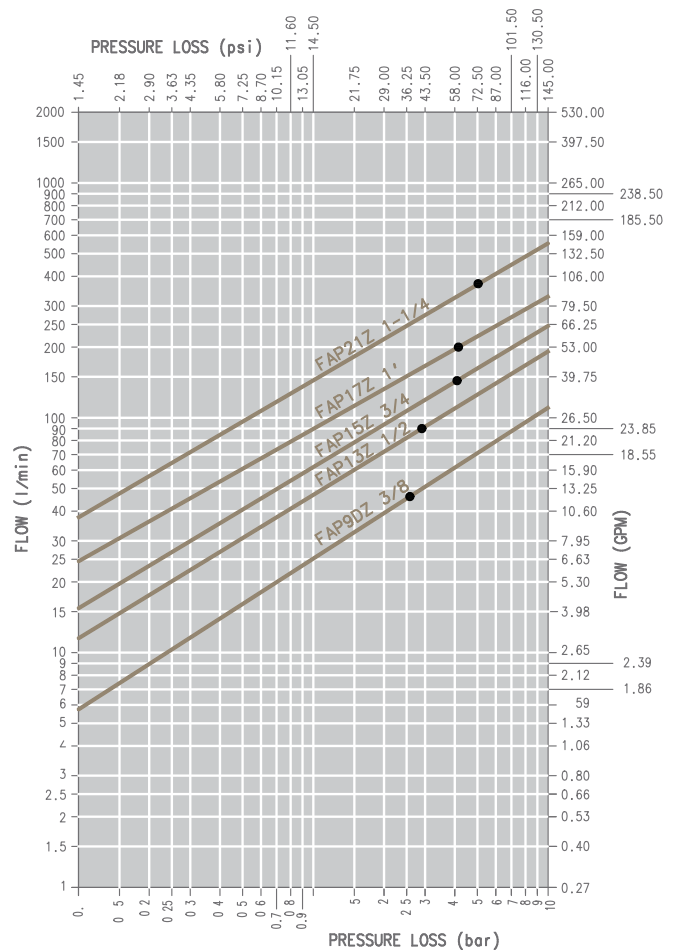
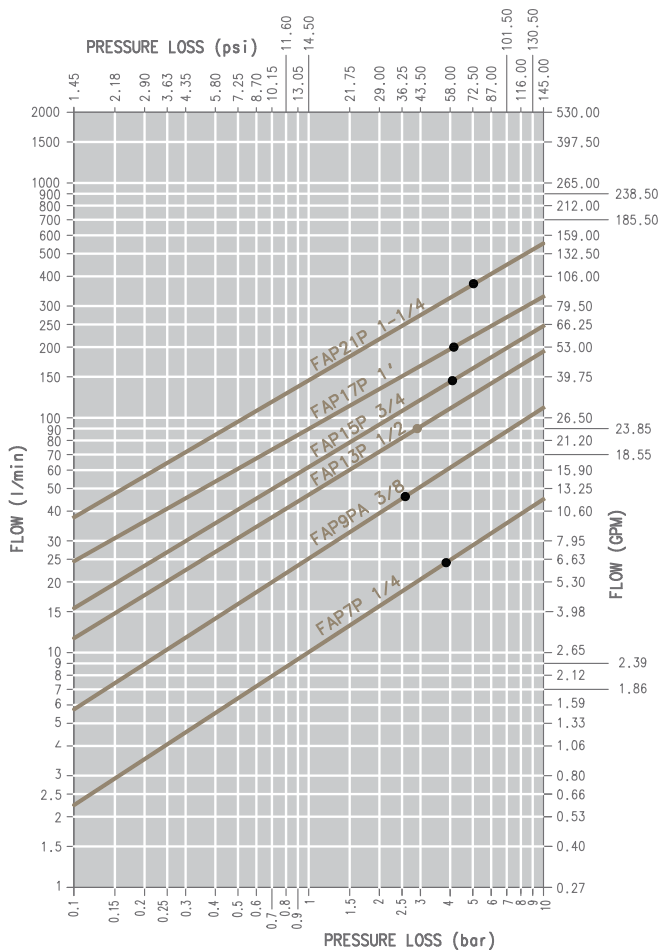





### FAP NPT and SAE Thread Replacement Couplers

PART	BODY SIZE	PORT SIZE	THREAD TYPE	ORDER CODE	PART DESCRIPTION
<b>FAP NPT THREAD</b>					
COUPLER	3/8	1/2	NPT	805001050	F. FAP9PA 1/2 NPT
NIPPLE	3/8	1/2	NPT	805001051	M. FAP9PA 1/2 NPT
COUPLER	3/8	3/8	NPT	805001052	F. FAP9PA 3/8 NPT
NIPPLE	3/8	3/8	NPT	805001053	M. FAP9PA 3/8 NPT
COUPLER	3/8	3/8	NPT	805001074	F. FAP9PD 3/8 NPT
NIPPLE	3/8	3/8	NPT	805001075	M. FAP9PD 3/8 NPT
COUPLER	3/8	1/2	NPT	805001076	F. FAP9PD 1/2 NPT
NIPPLE	3/8	1/2	NPT	805001077	M. FAP9PD 1/2 NPT
COUPLER	1/2	1/2	NPT	805001056	F. FAP13P 1/2 NPT
NIPPLE	1/2	1/2	NPT	805001057	M. FAP13P 1/2 NPT
COUPLER	1/2	3/4	NPT	805001058	F. FAP13P 3/4 NPT
NIPPLE	1/2	3/4	NPT	805001059	M. FAP13P 3/4 NPT
COUPLER	3/4	3/4	NPT	805001078	F. FAP15P 3/4 NPT
NIPPLE	3/4	3/4	NPT	805001079	M. FAP15P 3/4 NPT
COUPLER	1	1	NPT	805001082	F. FAP17P 1 NPT
NIPPLE	1	1	NPT	805001083	M. FAP17P 1 NPT
COUPLER	1 1/4	1 1/4	NPT	805001084	F. FAP21P 114 NPT
NIPPLE	1 1/4	1 1/4	NPT	805001085	M. FAP21P 114 NPT
<b>FAP SAE THREAD</b>					
COUPLER	3/8	1/2	SAE	805004020	F. FAP9PD 1/2 SAE
NIPPLE	3/8	1/2	SAE	805004021	M. FAP9PD 1/2 SAE
COUPLER	3/8	1/2	SAE	805004012	F. FAP9PA 1/2 SAE
NIPPLE	3/8	1/2	SAE	805004013	M. FAP9PA 1/2 SAE
COUPLER	1/2	1/2	SAE	805004004	F. FAP13P 1/2 SAE
NIPPLE	1/2	1/2	SAE	805004005	M. FAP13P 1/2 SAE
COUPLER	1/2	3/4	SAE	805004058	F. FAP13P 3/4 SAE
NIPPLE	1/2	3/4	SAE	805004059	M. FAP13P 3/4 SAE
COUPLER	1/2	5/8	SAE	805004005	F. FAP13P 5/8 SAE
NIPPLE	1/2	5/8	SAE	805004007	M. FAP13P 5/8 SAE
COUPLER	3/4	3/4	SAE	805004078	F. FAP15P 3/4 SAE
NIPPLE	3/4	3/4	SAE	805004079	M. FAP15P 3/4 SAE
COUPLER	1	1	SAE	805004082	F. FAP17P 1 SAE
NIPPLE	1	1	SAE	805004083	M. FAP17P 1 SAE
COUPLER	1 1/4	1 1/4	SAE	805004084	F. FAP21P 114 SAE
NIPPLE	1 1/4	1 1/4	SAE	805004085	M. FAP21P 114 SAE



COUPLER



NIPPLE

# MP Series Hydraulic Multi-Coupling Plate

## FAP Z NPT and SAE Thread Replacement Couplers

PART	BODY SIZE	PORT SIZE	THREAD TYPE	ORDER CODE	PART DESCRIPTION
<b>FAP Z NPT THREAD</b>					
COUPLER	3/8	3/8	NPT	808201002	F. FAP9AZ 3/8 NPT
NIPPLE	3/8	3/8	NPT	808201003	M. FAP9AZ 3/8 NPT
COUPLER	3/8	3/8	NPT	808201004	F. FAP9DZ 3/8 NPT
NIPPLE	3/8	3/8	NPT	808201005	M. FAP9DZ 3/8 NPT
COUPLER	1/2	1/2	NPT	808201010	F. FAP13Z 1/2 NPT
NIPPLE	1/2	1/2	NPT	808201011	M. FAP13Z 1/2 NPT
COUPLER	3/4	3/4	NPT	808201014	F. FAP15Z 3/4 NPT
NIPPLE	3/4	3/4	NPT	808201015	M. FAP15Z 3/4 NPT
COUPLER	1	1	NPT	808201016	F. FAP17Z 1 NPT
NIPPLE	1	1	NPT	808201017	M. FAP17Z 1 NPT
COUPLER	1 1/4	1 1/4	NPT	808201018	F. FAP21Z 1 1/4 NPT
NIPPLE	1 1/4	1 1/4	NPT	808201019	M. FAP21Z 1 1/4 NPT
<b>FAP Z SAE THREAD</b>					
COUPLER	3/8	1/2	SAE	808204004	F. FAP9DZ 1/2 SAE
NIPPLE	3/8	1/2	SAE	808204005	M. FAP9AZ 1/2 SAE
COUPLER	3/8	3/8	SAE	808204024	F. FAP9AZ 3/8 SAE
NIPPLE	3/8	3/8	SAE	808204025	M. FAP9AZ 3/8 SAE
COUPLER	3/8	3/8	SAE	808204026	F. FAP9DZ 3/8 SAE
NIPPLE	3/8	3/8	SAE	808204027	M. FAP9DZ 3/8 SAE
COUPLER	1/2	1/2	SAE	808204028	F. FAP13Z 1/2 SAE
NIPPLE	1/2	1/2	SAE	808204029	M. FAP13Z 1/2 SAE
COUPLER	1/2	3/4	SAE	808204012	F. FAP13Z 3/4 SAE
NIPPLE	1/2	3/4	SAE	808204013	M. FAP13Z 3/4 SAE
COUPLER	3/4	3/4	SAE	808204014	F. FAP15Z 3/4 SAE
NIPPLE	3/4	3/4	SAE	808204015	M. FAP15Z 3/4 SAE
COUPLER	1	1	SAE	808204016	F. FAP17Z 1 SAE
NIPPLE	1	1	SAE	808204017	M. FAP17Z 1 SAE
COUPLER	1 1/4	1 1/4	SAE	808204018	F. FAP21Z 1 1/4 SAE
NIPPLE	1 1/4	1 1/4	SAE	808204019	M. FAP21Z 1 1/4 SAE



COUPLER



NIPPLE

## Parking Stations

ORDER CODE	DESCRIPTION
815606009	PARKING STATION GR3-9
815606001	PARKING STATION GR6-9
815606003	PARKING STATION GR6-13
815606025	PARKING STATION GR10-13
815606029	PARKING STATION DP2-9
815606039	PARKING STATION DP4-9
815606037	PARKING STATION DP2-13
815606041	PARKING STATION DP4-13
815606013	PARKING STATION GR10-9





## Multi-Coupling: Series GRE

### Low Pressure Applications

The multi-coupling plate is a tool allowing the simultaneous couple and uncouple of a certain number of water, air, oil and/or electrical lines. From a minimum of 6 to a maximum of 18 lines can be simultaneously connected by a single, simple movement requiring very little effort. The energy lines can all have the same nominal diameter with different media according to the application.

Offered coupler sizes: 3/8 and 1/2 with various ports, low pressure applications

- Connects with residual pressure: 2-3 bar
- Safe lock prevents unwanted disconnection
- Simple to use with a single movement applied by only one arm
- Ease of maintenance or replacement of quick couplings

### Overview

The Stucchi GRE Series of Multi-Coupling Plates is designed as a solution for industrial applications such as fast tool changes on injection molding & die cast equipment. Coupling plates reduce downtime between production runs wherever pneumatic, oil, water, and electrical circuits are to be connected to production machines or test benches, etc. This series is designed to meet the requirements of flexible manufacturing of present and future production machines and processes. The GRE series connects with little effort due to its superior guidance pin system. The GRE series only connects in one position, preventing any connection error by inversion of circuits.

### Features & Options

- Compact aluminum manifold construction
- Port Options: female thread, hose barbs, 90 degree
- Valve options: Single shut-off, double shut-off, full flow
- Snap-ring mount allows easy installation and maintenance of couplers
- Auto-lock design prevents accidental disconnection
- Circuits: 6-12-18 positions

# GRE Series Instructions for Use

## GRE SERIES: INSTRUCTIONS FOR USE

LOCATE THE GUIDE PINS OF THE FIXED HALF AND THE RECEIVING PORT HOLES ON THE MOBILE HALF (HALF WITH THE HANDLE)



MOBILE HALF



FIXED HALF

01

Align and insert guide pins on fixed half into the mating port on the mobile half until pins are fully inserted.



02

Handle needs to be in the 12 o'clock starting position. Engage red locking mechanism and raise handle to the 12 o'clock starting position. Fixed half guide pins and mating ports will engage further to the proper starting position.



03

Engage red locking mechanism on the handle and move handle in a downward direction from 12 o'clock towards the 7 o'clock position.



04

Continue moving the handle until arriving at the 7 o'clock position. The handle will be locked in place once the locking pins are fully engaged and the mechanical click is heard.







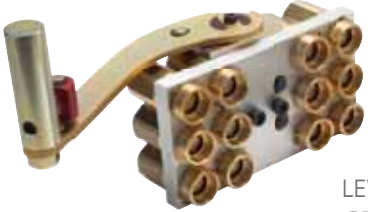

05

To disconnect reverse process: engage red locking mechanism and raise handle from 7 o'clock position to 12 o'clock position. Pull mobile half from fixed half pins.



GRE Plate Plates\_Component Identification Page

MOBILE HALF	FIXED HALF
 <p data-bbox="634 600 813 688">ERGONOMIC LEVER FOR EASE OF CONNECTION</p>	 <p data-bbox="1279 600 1507 688">GUIDE PINS ELIMINATE RISK OF MISALIGNED CIRCUIT</p>
DUST COVER FOR FIXED HALF	FIXED HALF WITH DUST COVER
	
MOBILE HALF PARKED IN PARKING STATION	PARKING STATION
	

**The Stucchi Solution to Connecting Multiple Couplings Simultaneously for Low Pressure Circuits**

1. Ergonomic lever for easy connect/disconnect with minimal effort
2. No risk of misalignment with guide pin design
3. Couplers mounted with snap rings for ease of installation or replacement
4. Easily mounted on new equipment or retrofit on pre-existing system

# GRE Series Hydraulic Multi-Coupling Plate

ORDER CODE STRUCTURE						
11	06	06	06	01	C	VM
SERIES NUMBER	NUMBER OF COUPLINGS	SIZE OF COUPLER	PORT SIZE	THREAD	SUFFIX	INDICATION OF NO VALVES
<b>11</b> = GRE 6-9 <b>12</b> = GRE12-9 <b>13</b> = GRE18-9 <b>21</b> = GRE 6-12 <b>22</b> = GRE12-12 <b>23</b> = GRE18-12	<b>01</b> # OF COUPLINGS <b>02</b> # OF COUPLINGS <b>03</b> # OF COUPLINGS ETC.	<b>06</b> = 3/8 <b>08</b> = 1/2	<b>06</b> = 3/8 <b>08</b> = 1/2	<b>01</b> = NPT <b>04</b> = SAE	<b>FH</b> = FIX HALF <b>MH</b> = MOBILE HALF <b>C</b> = COMPLETE	SUFFIX OPTION FOR NO VALVES ONLY <b>VM</b> = NO VALVES MALE NIPPLES



## MULTI-COUPLING PLATE SERIES OPTIONS: STANDARD STOCK PLATES

GRE 6-9	COMBINATION OF 3/8 INCH COUPLERS, UP TO 6 POSITIONS
GRE12-9	COMBINATION OF 3/8 INCH COUPLERS, UP TO 12 POSITIONS
GRE18-9	COMBINATION OF 3/8 INCH COUPLERS UP TO 18 POSITIONS
GRE 6-12	COMBINATION OF 1/2 INCH COUPLERS UP TO 6 POSITIONS
GRE12-12	COMBINATION OF 1/2 INCH COUPLERS UP TO 6 POSITIONS
GRE18-12	COMBINATION OF 1/2 INCH COUPLERS UP TO 18 POSITIONS



# GRE Multi-Coupling Plate: Order Codes

## Common Stock Items



ORDER CODE	DESCRIPTION	NUMBER OF COUPLERS	COUPLER SIZE	THREAD SIZE
110006060601C	GRE 6-9 (6) 3/8 NPT	6	3/8	3/8
120012060601C	GRE 12-9 (12) 3/8 NPT	12	3/8	3/8
130018060601C	GRE 18-9 (18) 3/8 NPT	18	3/8	3/8
210006080801C	GRE 6-12 (6) 1/2 NPT	6	1/2	1/2
220012080801C	GRE 12-12 (12) 1/2 NPT	12	1/2	1/2
230018080801C	GRE 18-12 (18) 1/2 NPT	18	1/2	1/2

THE ABOVE LIST CONSISTS OF THE MOST POPULAR STOCK ITEMS. STANDARD PLATES OFFER A VARIETY OF STANDARD COUPLER COMBINATIONS TOO BROAD TO LIST IN THIS CATALOG. USE THE STUCCHI ORDERING CODE SYSTEM TO CREATE A COUPLING PLATE CONFIGURATION FOR YOUR APPLICATION OR FILL OUT AND FAX THE CUSTOM PLATE FORM FOR NON-STANDARD CONFIGURATIONS (AVAILABLE ONLINE).



## GRE Series Replacement Couplers

ORDER CODE	BODY SIZE	THREAD SIZE	THREAD TYPE	PART DESCRIPTION
802101000	3/8	3/8	NPT	F. CSF9BN
802101003	3/8	3/8	NPT	M. CSM9BN
802101004	1/2	1/2	NPT	F. CSF12BN
802101005	1/2	1/2	NPT	M. CSM12BN

PRICES FOR PLATES AND COMPONENTS AVAILABLE UPON REQUEST

## Parking Stations



ORDER CODE	PART DESCRIPTION
815606033	PARKING STATION ALL PLATES

## Dust Cover



ORDER CODE	PART DESCRIPTION
81560609DC	FIXED PLATE DUST COVER FOR GRE 6 POSITION PLATE
81561212DC	FIXED PLATE DUST COVER FOR GRE 12 POSITION PLATE
81561809DC	FIXED PLATE DUST COVER FOR GRE 18 POSITION PLATE



# Saturn Block



## Saturn Block

### Technical Features & Options

- Interchangeability of couplings: equipped with ISO 16028 couplings size 1/2, 5/8, and 3/4 inch. Drain line is ISO 16028 size 3/8 or 1/2 inch male
- Couplings type: flat face
- Connection system: push to connect
- Disconnection system: pulling back the sleeve of the female coupling
- Connection with residual pressure: after draining the pressure with the knob
- Disconnection with residual pressure: after draining the pressure with the knob
- Threads available: 3/4 JIC for pressure lines, 3/8 SAE for drain line
- Threads on request: metric DIN, ORFS, SAE, BSP and others
- Surface treatment: CrIII zinc plated
- Seals: standard in NBR (Nitrile), POM
- Anti-extrusion rings: PTFE

### Main Applications

- Skid steers
- Excavators
- Mobile construction equipment
- Mini-excavators

### Features & Options

- User-friendly relief system allows for easy connection/disconnection with residual pressure
- Drain the residual pressure before connection and disconnection, allowing the connection without pressure and without effort in order to reduce injury risk
- Equipped with ISO 16028 interchangeable size 1/2 male & female parts flat face. Drain line in the middle is 3/8 size male.
- Direct replacement for other connect under pressure systems
- Low cost field replacement couplers
- Modular design allows for optional size 5/8 or 3/4 body male & female for high flow circuits and 1/2 drain line



DESCRIPTION	SIZE	MAX. OPERATING PRESSURE COUPLED		MAX. RESIDUAL PRESSURE DURING CONNECTION		SPILLAGE*
		MPa	psi	MPa	psi	ml
SATURN BLOCK 13	1/2	35	5075	25	3625	0.020
SATURN BLOCK 15	5/8	35	5075	25	3625	0.026
SATURN BLOCK 17	3/4	35	5075	25	3625	0.032

\* SPILLAGE IS AN INDICATIVE VALUE OF THE FLUID LOSS PER COUPLE-UNCUPLE CYCLE.

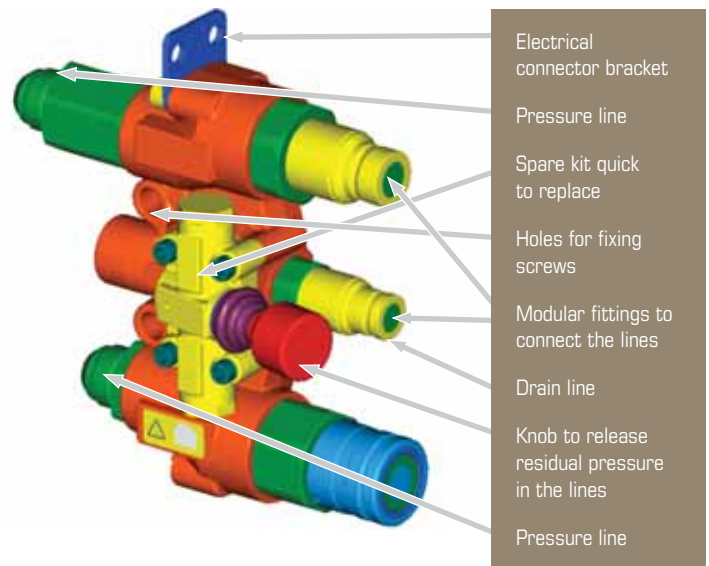
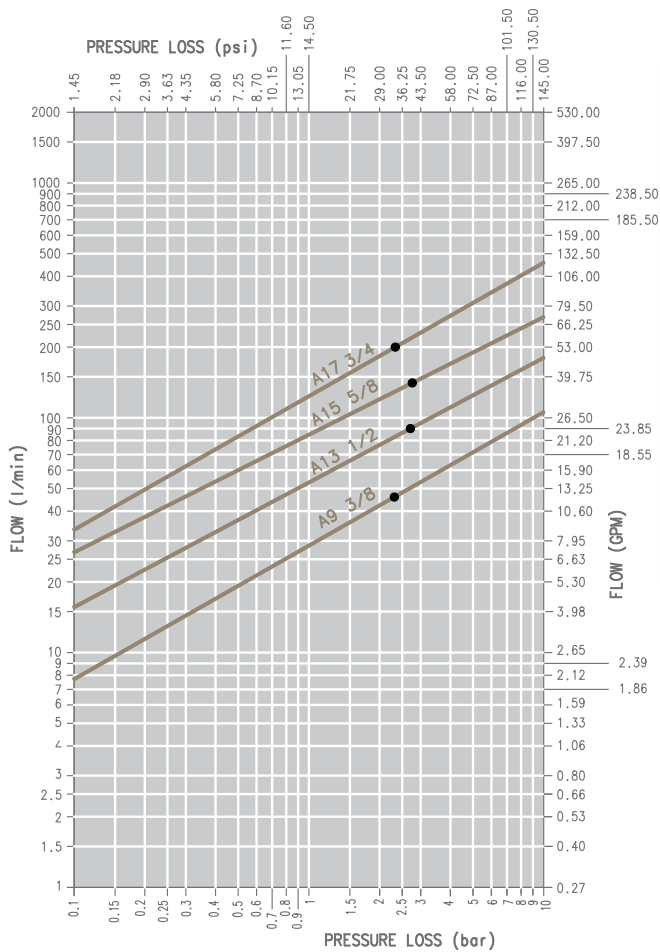

# Saturn Block

## Saturn Block: Size Diagram

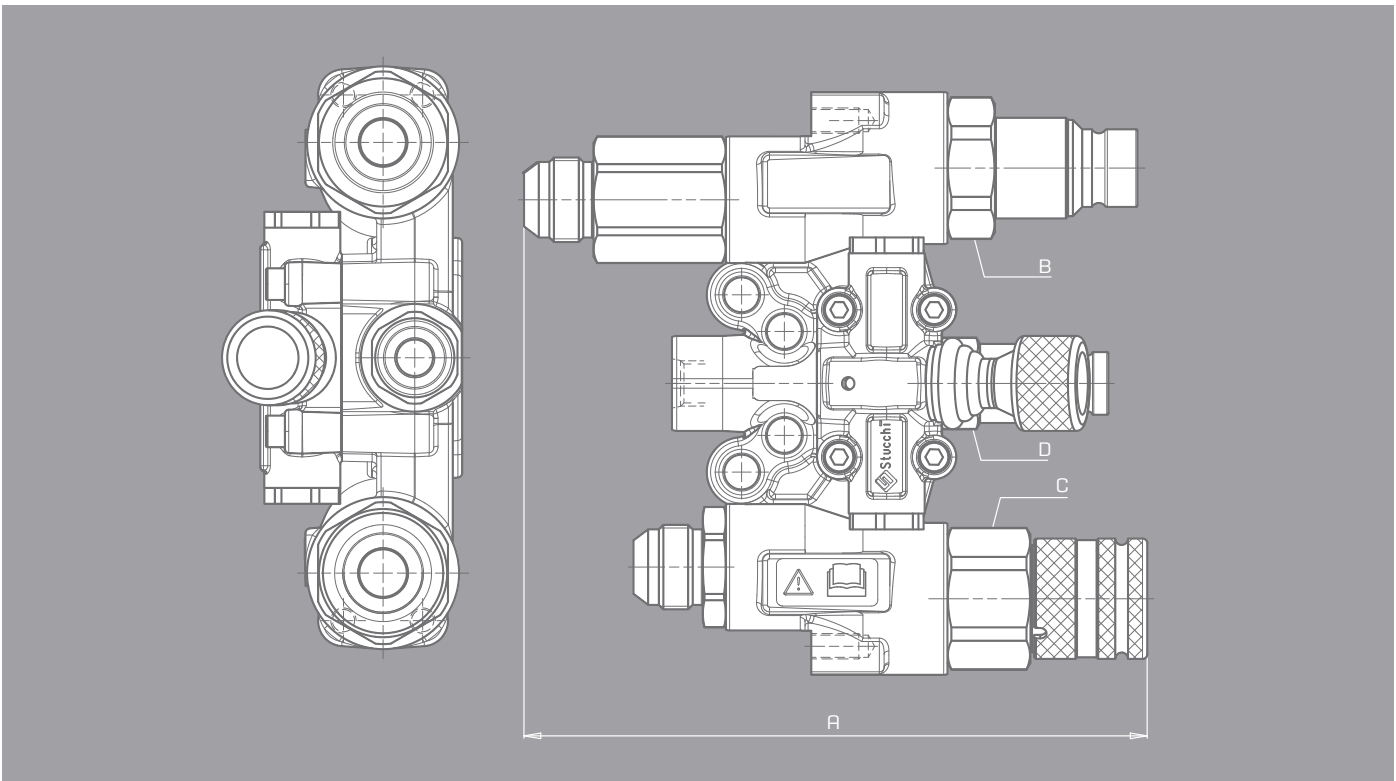

DESCRIPTION	SATURN BLOCK CODE	BODY SIZE	UNIT	A	B	C	D	UP	DRAIN	DOWN	UNIT	WEIGHT
SATURN BLOCK 13	808800102	1/2	mm	196.8	41	41	27	DN 12.5	DN 10	DN 12.5	Kg	4.312
			inch	7.75	1.61	1.61	1.06	1/2	3/8	1/2	lb	9.506
SATURN BLOCK 15	808800103	5/8	mm	203.7	41	41	27	DN 16	DN 10	DN 16	Kg	4.437
			inch	8.02	1.61	1.61	1.06	5/8	3/8	5/8	lb	9.782
SATURN BLOCK 17	808800104	3/4	mm	224	46	46	32	DN 19	DN 12.5	DN 19	Kg	5.052
			inch	8.82	1.81	1.81	1.26	3/4	1/2	3/4	lb	11.138

## Saturn Block: Order Codes

DESCRIPTION	ORDER CODE	BODY SIZE: COUPLER & NIPPLE	DRAIN LINE SIZE
SATURN BLOCK 13	808800102	1/2	3/8
SATURN BLOCK 15	808800103	5/8	3/8
SATURN BLOCK 17	808800104	3/4	1/2
SATURN BLOCK 17	808800105	3/4	3/8

\* USE "R" SUFFIX TO REVERSE POSITIONS OF COUPLER & NIPPLE IN THE SATURN BLOCK



## Saturn Block: How to Relieve Pressure

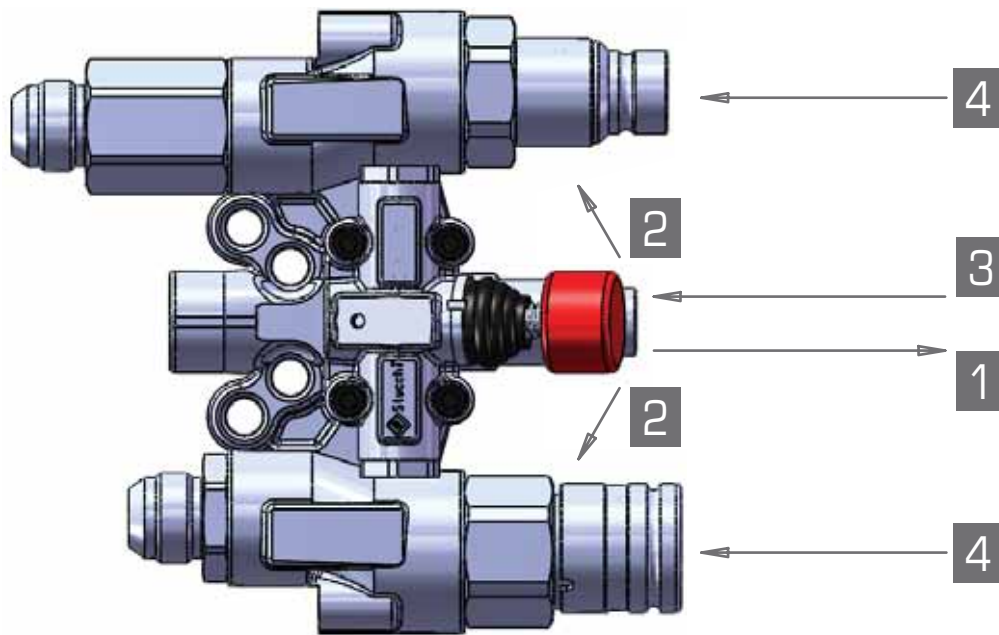

### How to Operate the Pressure Relief Valve on the Saturn Block

1. Pull red knob on pressure relief valve out
2. Pull red knob up/down to relieve pressure
3. Release red knob, allowing it return to starting position
4. Insert coupler/nipple into the Saturn Block

# Saturn Block

## Saturn Block: Replacement Parts List

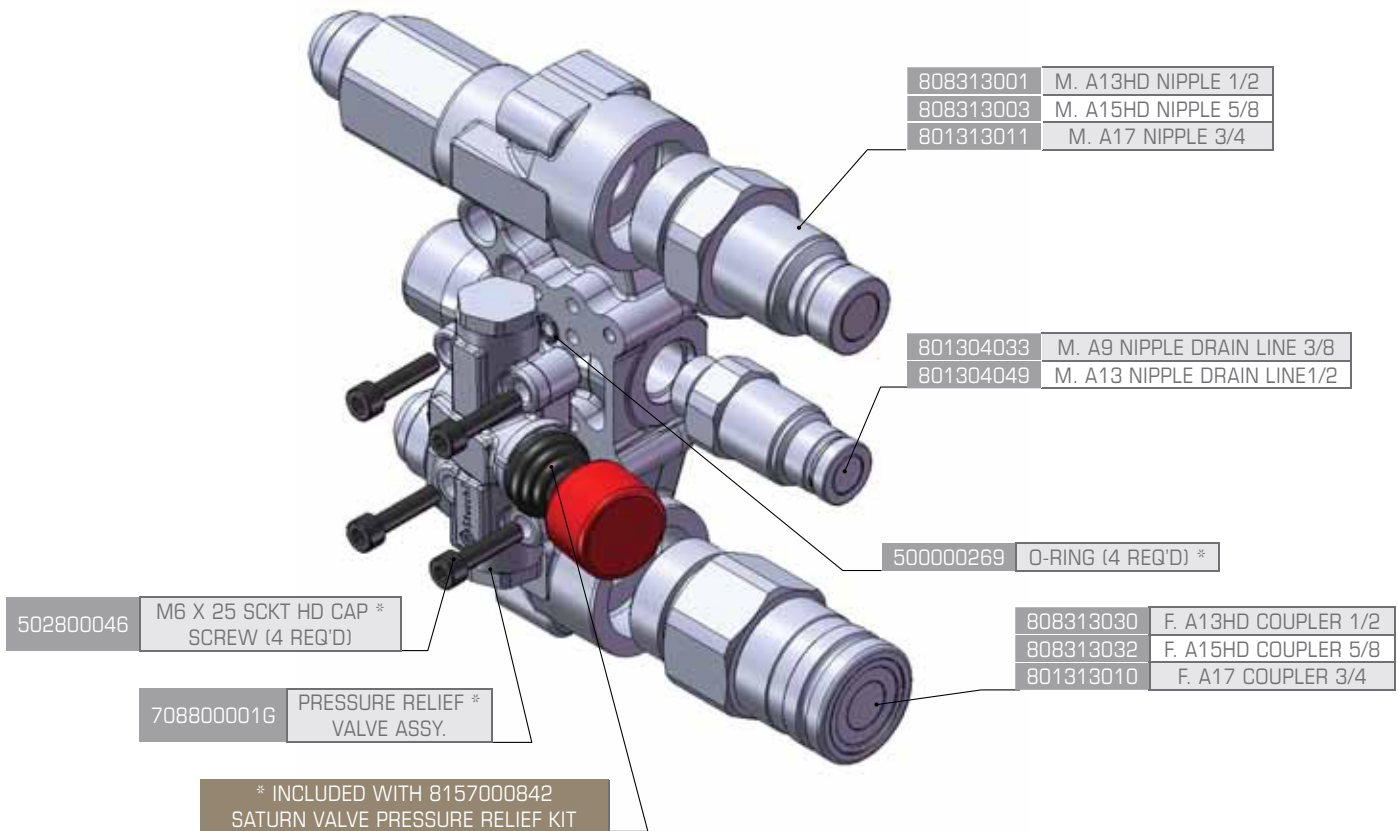

PART	ORDER CODE	DESCRIPTION
COUPLER	808313030	F. A13HD COUPLER
NIPPLE	808313001	M. A13HD NIPPLE
COUPLER	808313032	F. A15HD COUPLER
NIPPLE	808313003	M. A15HD NIPPLE
COUPLER	801313010	F. A17 COUPLER
NIPPLE	801313011	M. A17 NIPPLE
NIPPLE	801304033	M. A9 NIPPLE DRAIN LINE
NIPPLE	801304049	M. A13 NIPPLE DRAIN LINE
VALVE KIT	815700852	SATURN VALVE RELIEF KIT *



## Stucchi: Specialty Coupler

Specialty Couplers designed as solutions to customer applications. Replacement couplers for custom applications such as automation plates for cooling systems and hydraulics.

Type of fluids: cooling water (water and glycol, water and oil), hydraulic oil, grease.

Main feature: Minimum spilling during disconnection & low air inclusion at connection. 90 degree transmission of the fluid. Connectable under low pressure for the oil version of CQB series.

### Specialty Couplers\_Stucchi Exclusive

PART	BODY SIZE	PORT SIZE	THREAD TYPE	ORDER CODE	PART DESCRIPTION
<b>STUCCHI EXCLUSIVE SPECIALTY COUPLING CQB SERIES</b>					
COUPLER	1/2	1/2	BSP	802000114	F. CQBF12 1/2 BSP
NIPPLE	1/2	1/2	BSP	802000115	M. CQBM12P 1/2 BSP
COUPLER	3/4	3/4	BSP	802000116	F. CQBF20 3/4 BSP
NIPPLE	3/4	3/4	BSP	802000117	M. CQBM20 3/4 BSP
COUPLER	2	2	BSP	802000130	F. CQBF45 2 BSP
NIPPLE	2	2	BSP	802000131	M. CQBM45 2 BSP
COUPLER	2	2 1/2	BSP EXT	802000216	F. CQBF45E 2-1/2 BSP EST
COUPLER	2 1/2	3	BSP EXT	802000220	F. CQBF60E 3 BSP EST
NIPPLE	2 1/2	3	BSP	802000223	M. CQBM60E 3 BSP
COUPLER	2	1 1/2	BSP	802000226	F. CQLF45E 1-1/2 BSP
NIPPLE	2	1 1/2	BSP	802000227	M. CQLM45E 1-1/2 BSP
COUPLER	2	2 1/2	BSP EXT	802000228	F. CQLF45E 2-1/2 BSP EST
COUPLER	2	2	BSP EXT	802000232	F. CQLF45E 2 BSP EST
NIPPLE	2	2	BSP	802000233	M. CQLM45E 2 BSP
COUPLER	2	2	BSP EXT	802000238	F. CQBF45E 2 BSP EST
NIPPLE	2	1 1/2	BSP-90	802050201	M. CQLM45E 1-1/2 BSP 90
NIPPLE	2 1/2	3	BSP-90	802050203	M. CQLM60E BSP 90
<b>STUCCHI EXCLUSIVE SPECIALTY COUPLING FIRG SON</b>					
COUPLER	1/2	1/2	BSP	805700008	F. FIRG 12A SON BSP
NIPPLE	1/2	1/2	BSP	805700009	M. FIRG 12A SON BSP
COUPLER	3/4	3/4	BSP	805700010	F. FIRG 34B SON BSP
NIPPLE	3/4	3/4	BSP	805700011	M. FIRG 34B SON BSP

# Flat Face Series Protective Caps and Plugs



## Series: Protective Plugs

These are useful accessories which prevent dust, water or mud from entering the quick couplings and lengthen their lives. This is particularly important in the building industry in general and in earth moving where large quantities of materials such as sand, earth, etc. are moved.

- Material: PVC/rubber blend for flat face, and poppet series
- Material: aluminum of IVHP, VP, VEP series
- Nylon flip caps available on flat face
- Color: red is standard with options for black, blue, yellow, green, etc.
- In the description, F is the designation for the coupler, M is the designation for nipple



FEMALE CAP



MALE CAP

### FIRG and "A" Premier Flat Face Series\_ Coupler Dust Cap | Nipple Dust Cap

BODY SIZE	PORT SIZE	ORDER CODE	DESCRIPTION
<b>COUPLER/FEMALE DUST CAP</b>			
1/4	1/4	815100000	CAP F. FIRG14/A7
3/8	3/8	815100002	CAP F. FIRG38/A9/FIRG12
1/2	1/2	815100004	CAP F. FIRG12A/A13
1/2	1/2, 5/8, 3/4	815100006	CAP F. FIRG34/A13
5/8	3/4	815100008	CAP F. FIRG34B/A15
3/4	3/4, 1	815100010	CAP F. FIRG100/A17
1	1, 1 1/4	815100012	CAP F. FIRG1-1/4/A21
1 1/4	1 1/4	815105020	CAP F. A25
1 1/2	1 1/2	815100014	CAP F. FIRG112/A30
2	2	815100016	CAP F. FIRG 200
<b>NIPPLE/MALE DUST CAP</b>			
1/4	1/4	815100001	CAP M. FIRG14/A7
3/8	3/8	815100003	CAP M. FIRG38/A9
3/8	3/8, 1/2	815100005	CAP M. FIRG12/A9
1/2	1/2	815100007	CAP M. FIRG12A/A13
1/2	1/2, 5/8, 3/4	815100009	CAP M. FIRG34/A13
5/8	3/4	815100011	CAP M. FIRG34B/A15
3/4	3/4, 1	815100013	CAP M. FIRG100/A17
1	1, 1 1/4	815100015	CAP M. FIRG1-1/4/A21
1 1/4	1 1/4	815205021	CAP M. A25
1 1/2	1 1/2	815100017	CAP M. FIRG112/A30
2	2	815100019	CAP M. FIRG 200

ADDITIONAL COLORS AVAILABLE UPON REQUEST



# Protective Caps and Plugs



## VP Series\_Aluminum | Coupler Dust Cap | Nipple Dust Plug

BODY SIZE	ORDER CODE	DESCRIPTION
<b>VP COUPLER DUST CAP</b>		
1/4	815300000	CAP F. VP7R
3/8	815300002	CAP F. VP9R
1/2	815300004	CAP F. VP13R
3/4	815300006	CAP F. VP15R
1	815300008	CAP F. VP17R
1 1/4	815300010	CAP F. VP21R
1 1/2	815300012	CAP F. VP30R
<b>VP NIPPLE DUST PLUG</b>		
1/4	815300001	CAP M. VP7R
3/8	815300003	CAP M. VP9R
1/2	815300005	CAP M. VP13R
3/4	815300007	CAP M. VP15R
1	815300009	CAP M. VP17R
1 1/4	815300011	CAP M. VP21R
1 1/2	815300013	CAP M. VP30R



CAP



PLUG

## IRB Series\_Coupler Dust Plug | Nipple Dust Cap

BODY SIZE	ORDER CODE	DESCRIPTION
<b>IRB DUST PLUG</b>		
1/8	815000030	CAP F. IRB18
1/4	815000032	CAP F. IRB14
3/8	815000034	CAP F. IRB38
1/2	815000036	CAP F. IRB12
3/4	815000038	CAP F. IRB34
1	815000040	CAP F. IRB100
<b>IRB DUST CAP</b>		
1/4	815000031	CAP M. IRB18
1/4	815000033	CAP M. IRB14
3/8	815000035	CAP M. IRB38
1/2	815000037	CAP M. IRB12
3/4	815000039	CAP M. IRB34
1	815000041	CAP M. IRB100



PLUG



CAP

# Protective Caps and Plugs



PLUG



CAP

## VEP and VEP HD Series \_Aluminum | Coupler Dust Plug | Nipple Dust Cap

BODY SIZE	ORDER CODE	DESCRIPTION
<b>VEP AND VEP HD COUPLER DUST PLUG</b>		
1/4	815300030	CAP F. VEP7R
3/8	815300032	CAP F. VEP9R
1/2	815300034	CAP F. VEP13R
3/4	815300036	CAP F. VEP15R
1	815300038	CAP F. VEP17R
1 1/4	815300040	CAP F. VEP21R
1 1/2	815300028	CAP F. VEP30R
2	815300042	CAP F. VEP45
<b>VEP AND VEP HD NIPPLE DUST CAP</b>		
1/4	815300031	CAP M. VEP7R
3/8	815300033	CAP M. VEP9R
1/2	815300035	CAP M. VEP13R
3/4	815300037	CAP M. VEP15R
1	815300039	CAP M. VEP17R
1 1/4	815300041	CAP M. VEP21R
1 1/2	815300029	CAP M. VEP30R
2	815300043	CAP M. VEP45



PLUG



CAP

## ISO A BIR Series \_Coupler Dust Plug | Nipple Dust Cap

BODY SIZE	ORDER CODE	DESCRIPTION
<b>ISO A BIR COUPLER DUST PLUGS</b>		
1/4	815000012	CAP F. BIR 14
3/8	815000014	CAP F. BIR38
1/2	815000004	CAP F. BIR12
3/4	815000016	CAP F. BIR 34
1	815000018	CAP F. BIR 100
<b>ISO A BIR COUPLER DUST CAPS</b>		
1/4	815000013	CAP M. BIR 14
3/8	815000015	CAP M. BIR38
1/2	815000005	CAP M. BIR12
3/4	815000017	CAP M. BIR 34
1	815000019	CAP M. BIR100

## Ag Series IR and IRV \_Coupler Dust Plug | Nipple Dust Cap

BODY SIZE	ORDER CODE	DESCRIPTION
<b>IR AND IRV COUPLER DUST PLUGS</b>		
1/4	815000000	CAP F. IR14/IR14V
3/8	815000002	CAP F. IR38/IR38V
1/2	815000004	CAP F. IR12/IRS12/F. BIR12
3/4	815000006	CAP F. IR 34/IR34V
1	815000008	CAP F. IR 100/IR100V
<b>IR &amp; IRV COUPLER DUST CAPS</b>		
1/4	815000001	CAP M. IR14/IR14V
3/8	815000003	CAP M. IR38 IR38V
1/2	815000005	CAP M. IR1/M. BIR12
3/4	815000007	CAP M. IR34/IR34V
1	815000009	CAP M. IR100/IR100V



ORDER CODE	DESCRIPTION
<b>BIR SERIES REPAIR KIT - ISO A INTERCHANGE</b>	
815700170	KIT F. BIR14
815700172	KIT F. BIR38
815700174	KIT F. BIR12
815700176	KIT F. BIR34
815700178	KIT F. BIR100
815700180	KIT F. BIR114
815700182	KIT F. BIR112
815700184	KIT F. BIR200
815700177	KIT M./F. BIR34
815700179	KIT M./F. BIR100
815700181	KIT M./F. BIR114
815700183	KIT M./F. BIR112
815700185	KIT M./F. BIR200
<b>M. VEP O-RING KITS REPAIR KIT</b>	
815700735	O-RING KIT M. VEP7
815700736	O-RING KIT M. VEP 9
815700737	O-RING KIT M. VEP 13
815700738	O-RING KIT M. VEP 15
815700739	O-RING KIT M. VEP 17
815700740	O-RING KIT M. VEP 21
815700741	O-RING KIT M. VEP 30
815700728	O-RING KIT M. VEP 45

ORDER CODE	DESCRIPTION
<b>A PREMIER SERIES REPAIR KIT</b>	
815700097	KIT M. A9
815700099	KIT M. A13
815700101	KIT M. A15
815700103	KIT M. A17
815700105	KIT M. A21
815700107	KIT M. A30
<b>FIRG SERIES REPAIR KIT</b>	
815700001	KIT M. FIRG 14
815700003	KIT M. FIRG 38/12
815700005	KIT M. FIRG 12A/34
815700007	KIT M. FIRG 34B
815700009	KIT M. FIRG 100
815700011	KIT M. FIRG 114
815700013	KIT M. FIRG 112
815700015	KIT M. FIRG 200
<b>IRB SERIES KITS REPAIR KIT - ISO B INTERCHANGE</b>	
815700202	KIT F. IRB18
815700204	KIT F. IRB14
815700206	KIT F. IRB38
815700208	KIT F. IRB12
815700210	KIT F. IRB34
815700212	KIT F. IRB100
815700211	KIT M./F. IRB34
815700213	KIT M./F. IRB100



O-RING REPAIR KIT



FEMALE/MALE POPPET KIT

# Interchange Guide

THE FOLLOWING INTERCHANGE GUIDE IS OF THE MOST POPULAR INTERCHANGES STUCCHI USA INC. OFFERS.  
PLEASE CONTACT A CUSTOMER SERVICE REPRESENTATIVE FOR ITEMS NOT LISTED IN THE GUIDE.

ORDER CODE	STUCCHI	AEROQUIP	FASTER	HANSEN	PARKER	PERFECTING	SAFEWAY	SNAP-TITE	TOMCO
PAGE 59	ISO 7241-A INTERCHANGEABLE FEMALE / SOCKET								
800501000	F. BIR 14 NPT	5601-4-4S	ANV-14-NPT-F	2-I-16	6601-4-4	2KF2	S565-2	61C-4-4	CA5602-16
800501002	F. BIR 38 NPT	5601-6-6S	ANV-38-NPT-F	3-I-21	6601-6-6	3KF3	S565-3	61C-6-6	CA5603-21
800501004	F. BIR 12 NPT	5601-8-10S	NV-12-NPT-F	4-I-26	6601-8-10	4KF4	S565-4	61C-8-8	CA5604-26
800501006	F. BIR 34 NPT	5601-12-12S	ANV-34-NPT-F	6-I-31	6601-12-12	6KF6	S565-6	61C-12-12	CA5606-31
800501008	F. BIR 100 NPT	5601-16-16S	ANV-1-NPT-F	8-I-36	6601-16-16	8KF8	S565-8	61C-16-16	CA5608-36
PAGE 59	MALE / NIPPLE								
800501001	M. BIR 14 NPT	5602-4-4S	ANV-14-NPT-M	2-A-16	6602-4-4	K2F2	S561-2	61N-4-4	PA5602-16
800501003	M. BIR 38 NPT	5602-6-6S	ANV-38-NPT-M	3-A-21	6602-6-6	K3F3	S561-3	61N-6-6	PA5603-21
800501005	M. BIR 12 NPT	5602-8-10S	NV-12-NPT-M	4-A-26	6602-8-10	K4F4	S561-4	61N-8-8	PA5604-26
800501007	M. BIR 34 NPT	5602-12-12S	ANV-34-NPT-M	6-A-31	6602-12-12	K6F6	S561-6	61N-12-12	PA5606-31
800501009	M. BIR 100 NPT	5602-16-16S	ANV-1-NPT-M	8-A-36	6602-16-16	K8F8	S561-8	61N-16-16	PA5608-36
	PRODUCT OFFERING INCLUDES: 1 1/4, 1 1/2, 2								
PAGE 67	ISO 7241-B INTERCHANGEABLE FEMALE / SOCKET								
800601000	F. IRB 18 NPT	FD45-1003-02-02	HNV-18-NPT-F	1-H11	H1-62	1HF1	S105-1		TH1-11
800601002	F. IRB 14 NPT	FD45-1003-04-04	HNV-14-NPT-F	2-H16	H2-62	2HF2	S105-2	72C4-4	TH2-16
800601004	F. IRB 38 NPT	FD45-1003-06-06	HNV-38-NPT-F	3-H21	H3-62	3HF3	S105-3	72C6-6	TH3-21
800601006	F. IRB 12 NPT	FD45-1003-08-10	HNV-12-PT-F	4-HP26	H4-62	4HF4	S105-4	72C8-8	TH4-26
800601008	F. IRB 34 NPT	FD45-1003-12-12	HNV-34-NPT-F	6-HP31	H6-62	6HF6	S105-6	72C12-12	TH6-31
800601010	F. IRB 100 NPT	FD45-1003-16-16	HNV-1-NPT-F	8-HP36	H8-62	8HF8	S105-8	72C16-16	TH8-36
PAGE 67	MALE / NIPPLE								
800601001	M. IRB 18 NPT	FD45-1002-02-02	HNV-18-NPT-M	1-K11	H1-63	H1F1	S101-1		TK1-11
800601003	M. IRB 14 NPT	FD45-1002-04-04	HNV-14-NPT-M	2-K16	H2-63	H2F2	S101-2	72N4-4	TK2-16
800601005	M. IRB 38 NPT	FD45-1002-06-06	HNV-38-NPT-M	3-K21	H3-63	H3F3	S101-3	72N6-6	TK3-21
800601007	M. IRB 12 NPT	FD45-1002-08-10	HNV-12-NPT-M	4-KP26	H4-63	H4F4	S101-4	72N8-8	TK4-26
800601009	M. IRB 34 NPT	FD45-1002-12-12	HNV-34-NPT-M	6-KP31	H6-63	H6F6	S101-6	72N12-12	TK6-31
800601011	M. IRB 100 NPT	FD45-1002-16-16	HNV-1-NPT-M	8-KP36	H8-63	H8F8	S101-8	72N16-16	TK8-36
PAGE 68	FEMALE / SOCKET								
804601100	F. IRBX 18 NPT					1HF1-S	SS-105-1		TH1-11-303
804601102	F. IRBX 14 NPT	FD45-1076-04-04	HNV-14-NPT-F-2	ML2-H16	SSH2-62	2HF2-S	SS-105-2	S72C4-4	TH2-16-303
804601104	F. IRBX 38 NPT	FD45-1076-06-06	HNV-38-NPT-F-2	ML3-H21	SSH3-62	3HF3-S	SS-105-3	S72C6-6	TH3-21-303
804601106	F. IRBX 12 NPT	FD45-1076-08-10	HNV-12-NPT-F-2	ML4-H26	SSH4-62	4HF4-S	SS-105-4	S72C8-8	TH4-26-303
804601108	F. IRBX 34 NPT	FD45-1076-12-12	HNV-34-NPT-F-2	ML6-H31	SSH6-62	6HF6-S	SS-105-6	S72C12-12	TH6-31-303
804601110	F. IRBX 100 NPT	FD45-1076-16-16	HNV-1-NPT-F-2	ML8-H36	SSH8-62	8HF8-S	SS-105-8	S72C16-16	TH8-36-303
	316 STAINLESS STEEL								
PAGE 68	MALE / NIPPLE								
804601101	M. IRBX 18 NPT					H1F1-S	SS-101-1		TK1-11-303
804601103	M. IRBX 14 NPT	FD45-1004-04-04	HNV-14-NPT-M-2	ML2-K16	SSH2-63	H2F2-S	SS-101-2	S72N4-4	TK2-16-303
804601105	M. IRBX 38 NPT	FD45-1004-06-06	HNV-38-NPT-M-2	ML3-K21	SSH3-63	H3F3-S	SS-101-3	S72N6-6	TK3-21-303
804601107	M. IRBX 12 NPT	FD45-1004-08-10	HNV-12-NPT-M-2	ML4-K26	SSH4-63	H4F4-S	SS-101-4	S72N8-8	TK4-26-303
804601109	M. IRBX 34 NPT	FD45-1004-12-12	HNV-34-NPT-M-2	ML6-K31	SSH6-63	H6F6-S	SS-101-6	S72N12-12	TK6-31-303
804601111	M. IRBX 100 NPT	FD45-1004-16-16	HNV-1-NPT-M-2	ML8-K36	SSH8-63	H8F8-S	SS-101-8	S72N16-16	TK8-36-303
	ISO B BRASS								
PAGE 67	FEMALE / SOCKET								
804501100	F. IRBOV 18 NPT					1HF1-B	BS-105-1		TH1-11-002
804501102	F. IRBOV 14 NPT	FD45-1101-04-04	HNV-14-NPT-F-5	B2-H16	BH2-60	2HF2-B	BS-105-2	B72C4-4	TH2-16-002
804501104	F. IRBOV 38 NPT	FD45-1101-06-06	HNV-38-NPT-F-5	B3-H21	BH3-60	3HF3-B	BS-105-3	B72C6-6	TH3-21-002
804501106	F. IRBOV 12 NPT	FD45-1101-08-10	HNV-12-NPT-F-5	B4-H26	BH4-60	4HF4-B	BS-105-4	B72C8-8	TH4-26-002
804501108	F. IRBOV 34 NPT	FD45-1101-12-12	HNV-34-NPT-F-5	B6-H31	BH6-60	6HF6-B	BS-105-6	B72C12-12	TH6-31-002
804501110	F. IRBOV 100 NPT	FD45-1101-16-16	HNV-1-NPT-F-5	B8-H36	BH8-60	8HF8-B	BS-105-8	B72C16-16	TH8-36-002
PAGE 67	MALE / NIPPLE								
804501101	M. IRBOV 18 NPT					H1F1-B	BS-101-1		TK1-11-002
804501103	M. IRBOV 14 NPT	FD45-1086-04-04	HNV-14-NPT-M-5	B2-K16	BH2-61	H2F2-B	BS-101-2	B72N4-4	TK2-16-002
804501105	M. IRBOV 38 NPT	FD45-1086-06-06	HNV-38-NPT-M-5	B3-K21	BH3-61	H3F3-B	BS-101-3	B72N6-6	TK3-21-002
804501107	M. IRBOV 12 NPT	FD45-1086-08-10	HNV-12-NPT-M-5	B4-K26	BH4-61	H4F4-B	BS-101-4	B72N8-8	TK4-26-002
804501109	M. IRBOV 34 NPT	FD45-1086-12-12	HNV-34-NPT-M-5	B6-K31	BH6-61	H6F6-B	BS-101-6	B72N12-12	TK6-31-002
804501111	M. IRBOV 100 NPT	FD45-1086-16-16	HNV-1-NPT-M-5	B8-K36	BH8-61	H8F8-B	BS-101-8	B72N16-16	TK8-36-002



ORDER CODE	STUCCHI	AEROQUIP	FASTER	HANSEN	PARKER	PERFECTING	SAFEWAY	SNAP-TITE	TOMCO
PAGE 19	ISO 16028 INTERCHANGEABLE FEMALE / SOCKET								
800801000	F. FIRG 14 NPT	FD89-1001-04-04	2FFI-14-NPT-F	6FFS25	FEM-251-4FP	2HGF2	FFE495-2	74C 4-4F	EC2-16
800801004	F. FIRG 38 NPT	FD49-1001-06-06	2FFN-38-NPT-F	10FFS37	FF-371-6FP	3HGF3 / 3HTF3	FFE495-3	74C-6-6F	EC3-21
800801002	F. FIRG 12 NPT	FD49-1001-08-06	2FFN-38-12-NPT-F	10FFS50	FF-371-8FP	3HGF4 / 3HTF4	FFE495-3-8	74C-6-8F	EC3-26
800801006	F. FIRG 12A NPT	FD89-1001-08-08	2FFI-12-NPT-F	12FFS50	FEM-501-8FP	4HGF4 / 4HTF4	FFE495-4	74C 8-8F	EC4-26
800801008	F. FIRG 34 NPT	FD89-1001-12-08	2FFI-12-34-NPT-F	12FFS75		4HTF6	FFE495-4-3/4	74C 8-12F	EC4-31
800801010	F. FIRG 34B NPT	FD89-1001-12-12	2FFI-58-34-NPT-F	16FFS75		5HTF6		74C10-12F	EC6-31
800801020	F. FIRG 34A NPT		2FFI-34-NPT-F	19FFS75	FEM-751-12FP	6HTF6	FFE-495-6	74C12-12F	
800801012	F. FIRG 100 NPT	FD89-1001-16-16	2FFI-34-1-NPT-F	19FFS100		6HTF8	FFE-495-6-1	74C12-16F	EC8-36
800801014	F. FIRG 114 NPT	FD89-1001-20-20		25FFS125		8HTF10	FFE495-8-114	74C16-20F	
800801016	F. FIRG 112 NPT	FD89-1001-24-24	FFI 112 NPT-F						
800801018	F. FIRG 200 NPT	FD89-1001-32-32	2FFI2-NPT-F						
PAGE 19	MALE / NIPPLE								
800801001	M. FIRG 14 NPT	FD89-1002-04-04	2FFI-14-NPT-M	6FFP25	FEM-252-4FP	HG2F2	FFE491-2	74N 4-4F	EP2-16
800801005	M. FIRG 38 NPT	FD49-1002-06-06	2FFN-38-NPT-M	10FFP37	FF-372-6FP	HG3F3 / HT3F3	FFE491-3	74N-6-6F	EP3-21
800801003	M. FIRG 12 NPT	FD49-1002-08-06	2FFN-38-12-NPT-M	10FFP50	FF-372-8FP	HG3F4 / HT3F4	FFE491-3-8	74N-6-8F	EP3-26
800801007	M. FIRG 12A NPT	FD89-1002-08-08	2FFI-12-NPT-M	12FFP50	FEM-502-8FP	HG4F4 / HT4F4	FFE491-4	74N 8-8F	EP4-26
800801009	M. FIRG 34 NPT	FD89-1002-12-08	2FFI-12-34-NPT-M	12FFP75		HT4F6	FFE491-4-3/4	74N 8-12F	EP4-31
800801011	M. FIRG 34B NPT	FD89-1002-12-12	FFI-58-34-NPT-M	16FFP75		HG5F6 / HT5F6		74N10-12F	EP6-31
800801021	M. FIRG 34A NPT		FFI-34-NPT-M	19FFP75	FEM-752-12FP	HT8F6	FFE-491-6	74N12-12F	
800801013	M. FIRG 100 NPT	FD89-1002-16-16	FFI-34-1-NPT-M	19FFP100		HT8F8	FFE-491-6-1	74N12-16F	EP8-36
800801015	M. FIRG 114 NPT	FD89-1002-20-20		25FFP125		HT8F10	FFE-491-8-114	74N16-20F	
800801017	M. FIRG 112 NPT	FD89-1002-24-24	FFI 112 NPT M						
800801019	M. FIRG 200 NPT	FD89-1002-32-32	FFI 2 NPT M						
PAGE 19	ISO 16028 INTERCHANGEABLE FEMALE / SOCKET								
800804000	F. FIRG 14 3/8 SAE	FD89-1005-06-04	2FFI-14-38-SAE-F		FEM-251-6FO		FFE495-2-6	74C 4-6EF	
800804002	F. FIRG 38 1/2 SAE	FD89-1005-08-06	2FFI-38-12-SAE-F		FEM-371-8FO	3 HTOF4	FFE495-3-8	74C-6-8EF	EC3-8
800804004	F. FIRG 12 5/8 SAE	FD89-1005-10-06							
800804006	F. FIRG 12A 5/8 SAE	FD89-1005-10-08				4HTOF5		74C-8-10EF	
800804008	F. FIRG 34 SAE	FD89-1005-12-08	2FFI-12-34-SAE-F	12FFS106UN	FEM-501-12FO	4HTOF6	FFE495-4-12	74C-8-12EF	EC4-12
800804010	F. FIRG 34B SAE	FD89-1005-12-12	2FFI-58-34-SAE-F		FEM-621-12FO	5HTOF6		74C-10-12EF	
800804020	F. FIRG 34A SAE		2FFI 34-34-SAE-F		FEM-751-12FO	6HTOF6		74C12-12EF	
800804012	F. FIRG 100 SAE	FD89-1005-16-16	2FFI 34-1-SAE-F			6HTOF8	FFE-495-6-16	74C12-16EF	
PAGE 19	MALE / NIPPLE								
800804001	M. FIRG 14 3/8' SAE	FD89-1004-06-04	2FFI-14-38-SAE-M		FEM-252-6FO		FFE491-2-6	74N 4-6EF	
800804003	M. FIRG 38 1/2' SAE	FD89-1004-08-06	2FFI-38-12-SAE-M		FEM-372-8FO	HT30F4	FFE491-3-8	74N-6-8EF	EP3-8
800804005	M. FIRG 12 5/8' SAE	FD89-1004-10-06							
800804007	M. FIRG 12A 5/8' SAE	FD89-1004-10-08				HT40F5		74N-8-10EF	
800804009	M. FIRG 34 SAE	FD89-1004-12-08	2FFI-12-34-SAE-M	12FFP106UN	FEM-502-12FO	HT40F6	FFE491-4-12	74N-8-12EF	EP4-12
800804011	M. FIRG 34B SAE	FD89-1004-12-12	FFI-58-34-SAE-M		FEM-622-12FO	HT50F6		74N-10-12EF	
800804021	M. FIRG 34A SAE		FFI 34-34-SAE-M		FEM-752-12FO	HT60F6		74N12-12EF	
800804013	M. FIRG 100 SAE	FD89-1004-16-16	FFI 34-1-SAE-M			HT60F8	FFE-491-6-16	74N12-16EF	
PAGE 9	ISO 16028 INTERCHANGEABLE FEMALE / SOCKET								
801301002	F. A4 1/8 NPT								
801301004	F. A7 1/4 NPT	FD99-1001-04-04	2FFI-14-NPT-F	6FFS25	FEM-251-4FP		FFE495-2	74C4-4F	EC2-16
801301006	F. A9 3/8 NPT	FD99-1001-06-06	2FFN-38-NPT-F	10FFS37	FEM-371-6FP	3HTF3	FFE495-3	74C6-6F	EC3-21
801301008	F. A9 1/2 NPT	FD99-1001-08-06	2FFN-38-12-NPT-F	10FFS50		3HTF4	FFE495-3-8	74C6-8F	EC3-26
801301010	F. A13 1/2 NPT	FD99-1001-08-08	2FFI-12-NPT-F	12FFS50	FEM-501-8FP	4HTF4	FFE495-4	74C8-8F	EC4-26
801301012	F. A13 3/4 NPT	FD99-1001-12-08	2FFI-12-34-NPT-F	12FFS75		4HTF6	FFE495-4-3/4	74C8-12F	EC4-31
801301014	F. A15 3/4 NPT	FD99-1001-12-12	2FFI-58-34-NPT-F	16FFS75		5HTF6		74C10-12F	EC6-31
801301000	F. A17 1 NPT	FD99-1001-16-16	2FF-34-1-NPT-F	19FFS100		6HTF8	FFE-495-6-1	74C12-16F	EC8-36
801301030	F. A17 3/4 NPT		2FFI-34-NPT-F	19FFS75	FEM-751-12FP	6HTF6	FFE-495-6	74C12-12F	
801301028	F. A21 1 NPT		2FFI-1-NPT-F		FEM-1001-16FP	8HTF8	FFE-495-8	74C16-16F	
801301016	F. A21 114 NPT			25FFS125		8HTF10	FFE-495-8-114		
801301018	F. A30 112 NPT					12HTF10			

# Interchange Guide

ORDER CODE	STUCCHI	AEROQUIP	FASTER	HANSEN	PARKER	PERFECTING	SAFEWAY	SNAP-TITE	TOMCO
PAGE 9	MALE / NIPPLE								
801301003	M. A4 1/8 NPT								
800801001	M. FIRG 14 NPT	FD99-1002-04-04	2FFI-14-NPT-M	6FFP25	FEM-252-4FP		FFE491-2	74N4-4F	
801301005	M. A9 3/8 NPT	FD99-1002-06-06	FFN-38-NPT-MU	10FFP37	FEM-372-6FP	HT3F3	FFE491-3	74N6-6F	EP3-21
801301007	M. A9 1/2 NPT	FD99-1002-08-06	FFN-38-12-NPT-MU	10FFP50		HT3F4	FFE491-3-8	74N6-8F	
801301009	M. A13 1/2 NPT	FD99-1002-08-08	FFI-12-NPT-M	12FFP50	FEM-502-8FP	HT4F4	FFE491-4	74N8-8F	EP4-26
801301011	M. A13 3/4 NPT	FD99-1002-12-08	FFI-12-34-NPT-M	12FFP75		HT4F6	FFE491-4-3/4	74N8-12F	EP4-31
801301013	M. A15 3/4 NPT	FD99-1002-12-12	FFI-58-34-NPT-M	16FFP75		HG5F6 / HT5F6		74N10-12F	EP6-31
801301001	M. A17 1 NPT	FD99-1002-16-16	FF-34-1-NPT-M	19FFP100		HT6F8	FFE-491-6-1	74N12-16F	EP8-36
801301031	M. A17 3/4 NPT		FFI-34-NPT-M	19FFP75	FEM-752-12FP	HT6F6	FFE-491-6	74N12-12F	
801301029	M. A21 1 NPT		FFI-1-NPT-M		FEM-1002-16FP	HT8F8	FFE-491-8	74N16-16F	
801301015	M. A21 114 NPT			25FFP125		HT8F10	FFE-491-8-114		
801301017	M. A30 112 NPT					HT12F12			
PAGE 10	ISO 16028 INTERCHANGEABLE FEMALE / SOCKET								
801304002	F. A4 3/16 SAE								
801304004	F. A7 3/8 SAE	FD99-1005-06-04	2FFI-14-38-SAE-F		FEM-251-6FO		FFE495-2-6		
801304006	F. A9 3/8 SAE		2FFN-38-38-SAE-F			3HTOF3		74C 6-6EF	
801304008	F. A9 1/2 SAE	FD99-1005-08-06	2FFN-38-12-SAE-F		FEM-371-8FO	3HTOF4	FFE495-3-8	74C 6-8EF	EC3-8
801304030	F. A9 5/8 SAE	FD99-1005-10-06							
803304004	F. A13 1/2 SAE		2FFI-12-12-SAE-F			4HTOF4			
801304024	F. A13 5/8 SAE	FD99-1005-10-08	2FFI-12-58-SAE-F		FEM-501-10FO	4HTOF5		74C-8-10EF	
801304010	F. A13 3/4 SAE	FD99-1005-12-08	2FFI-12-34-SAE-F	12FFS106UN	FEM-501-12FO	4HTOF6	FFE495-4-12	74C-8-12EF	EC4-12
801304012	F. A15 3/4 SAE	FD99-1005-12-12	2FFI-58-34-SAE-F		FEM-621-12FO	5HTOF6		74C10-12EF	
801304028	F. A17 3/4 SAE		2FFI-34-34-SAE-F		FEM-721-12FO	6HTOF6		74C12-12EF	
801304000	F. A17 1 SAE	FD99-1005-16-16	2FFI-34-1-SAE-F			6HTOF8	FFE495-6-16	74C12-16EF	
801304038	F. A21 1 SAE		2FFI-1-1-SAE-F		FEM-1001-16FO	8HTOF8	FFE-495-8-20	74C16-16EF	
PAGE 10	MALE / NIPPLE								
801304003	M. A4 3/16 SAE								
800804001	M. FIRG 14 3/8 SAE	FD99-1004-06-04	2FFI-14-38-SAE-M		FEM-252-6FO		FFE491-2-6	74N4-6EF	
801304005	M. A9 3/8 SAE		2FFN-38-38-SAE-M			HT30F3		74N6-6EF	
801304007	M. A9 1/2 SAE	FD99-1004-08-06	2FFN-38-12-SAE-M		FEM-372-8FO	HT30F4	FFE491-3-8	74N6-8-EF	EP3-8
801304031	M. A9 5/8 SAE	FD99-1004-10-06							
801304035	M. A13 1/2 SAE		2FFI-12-12-SAE-M			HT40F4		74N8-8EF	
801304025	M. A13 5/8 SAE	FD99-1004-10-08	2FFI-12-58-SAE-M		FEM-502-10FO	HT40F5		74N8-10EF	
801304009	M. A13 3/4 SAE	FD99-1004-12-08	2FFI-12-34-SAE-M	12FFP106UN	FEM-502-12FO	HT40F6	FFE491-4-12	74N8-12EF	EP4-12
801304011	M. A15 3/4 SAE	FD99-1004-12-12	FFI-58-34-SAE-M		FEM-622-12FO	HT50F6		74N10-12EF	
801304029	M. A17 3/4 SAE		FFI-34-34-SAE-M		FEM-722-12FO	HT60F6		74C12-12EF	
801304000	M. A17 1 SAE	FD99-1004-16-16	FFI-34-1-SAE-M			HT60F8	FFE491-6-16	74C12-1EF	
801304039	M. A21 1 SAE		FFI-1-1-SAE-M		FEM-1002-16FO	HT80F8	FFE-491-8-20	74N16-1EF	
PAGE 23	ISO 16028 CONNECT UNDER PRESSURE								
805201001	M. APM 9 3/8 NPT		3FFI-38 NPT M						
805201003	M. APM 9 1/2 NPT		3FFI-38-12N M						
805201005	M. APM 13 1/2 NPT		3FFI-12-NPT-M		FEC-502-8FP			CP74N8-8F	
805201007	M. APM 13 3/4 NPT		3FFI-12-34-N-M						
805201009	M. APM 15 3/4 NPT		3FFI-58-34-N-M						
805201011	M. APM 17 1 NPT		3FFI-34-1-N-M						
805201017	M. APM 21 114 NPT		3FFI-1-114-N-M		FEC-1001				
805201015	M. APM 30 112 NPT								
805204001	M. APM 9 1/2 SAE		3FFI-38-12-SAE-M						
805204003	M. APM 13 5/8 SAE		3FFI-12-58-SAE-M		FEC-502-10FO			CP74N8-10EF	
805204005	M. APM 13 3/4 SAE		3FFI-12-34-SAE-M		FEC-502-12FO			CP74N8-12EF	
805204007	M. APM 15 3/4 SAE		3FFI-58-34-SAE-M		FEC-622-12FO				
805204009	M. APM 17 1 SAE		3FFI-34-1-S-M		FEC-752				
805204017	M. APM 21 114 SAE		3FFI-1-114-SAE-M		FEC-1001				
805204015	M. APM 30 112 SAE								



ORDER CODE	STUCCHI	AEROQUIP	FASTER	HANSEN	PARKER	PERFECTING	SAFEWAY	SNAP-TITE	TOMCO
PAGE 80	ENERPAC INTERCHANGE FEMALE / SOCKET								
800201008	F. IVHP 14 NPT		PVVM 1/14-NPT-F		3050-2	2TM2	S35-2		JC2-15
800201004	F. IVHP 38 NPT		PVVM 1/38-NPT-F		3050-3	3TF3	S35-3		JC3-20
PAGE 80	MALE / NIPPLE								
800201009	M. IVHP 14 NPT		PVVM-14-NPT-M		3010-2	T2M2	S31-2		JP2-16
800201005	M. IVHP 38 NPT		PVVM-38-NPT-M		3010-3	T3F3	S31-3		JP3-21
PAGE 74	AG -POPPET INTERCHANGE FEMALE / SOCKET								
800101000	F. IRV 14 NPT	FD42-1001-04-04	NV-14-NPT-F		4050-2P	2AGF2-PV	S25A-2P	60C4-4F	C2-16
800101002	F. IRV 38 NPT		NV-38-NPT-F		4050-3P	3AGF3-PV	S25-3P	60C6-6F	C3-21
800501004	F. BIR 12 NPT	G5601-8-10	NV-12-NPT-F		4050-4P	4AGF4-PV	S25-4P		C4-26
800101004	F. IRV 34 NPT		NV-34-NPT-F*		4050-5P	6AGF6-PV	S25F-6P		C6-31
800101006	F. IRV 100 NPT		NV-1-NPT-F		4050-6P	8AGF8-PV	S25-8P		C8-36
PAGE 74	MALE / NIPPLE								
800101001	M. IRV 14 NPT	FD42-1002-04-04	NV-14-NPT-M		4010-2P	AG2F2-PV	S41-2P	60N4-4F	P2-16
800101003	M. IRV 38 NPT		NV-38-NPT-M		4010-3P	AG3F3-PV	S41-3P	60N6-6F	P3-21
800501005	M. BIR 12 NPT	G5602-8-10	NV-12-NPT-M		8010-4P	AG4F4-PV	S71-4P		P4-26
800101005	M. IRV 34 NPT		NV-34-NPT-M*		4010-5P	AG6F6-PV	S21F-6P		P6-31
800101007	M. IRV 100 NPT		NV-1-NPT-M		4010-6P	AG8F8-PV	S21-8P		P8-36
	* FA VERSION NEEDED TO INTERCHANGE								
PAGE 75	AG -BALL VALVE INTERCHANGEABLE FEMALE / SOCKET								
800001000	F. IR 14 NPT		NS-14-NPT-F		4050-2	2AGF2	S25A-2		
800001002	F. IR 38 NPT		NS-38-NPT-F		4050-3	3AGF3	S25-3		
800001004	F. IR 12 NPT		NS-12-NPT-F		4050-4	4AGF4	S25-4		
800001006	F. IR 34 NPT		NS-34-NPT-F		4150-5	6AGF6	S25F-6		
800001008	F. IR 100 NPT		NS-1-NPT-F			8AGF8	S25-8		
PAGE 75	MALE / NIPPLE								
800001001	M. IR 14 NPT		NS-14-NPT-M		4010-2	AG2F2	S41-2		
800001003	M. IR 38 NPT		NS-38-NPT-M		4010-3	AG3F3	S41-3		
800001005	M. IR 12 NPT		NS-12-NPT-M		8010-4	AG4F4	S71-4		
800001007	M. IR 34 NPT		NS-34-NPT-M*		4110-5	AG6F6	S21F-6		
800001009	M. IR 100 NPT		NS-1-NPT-M			AG8F8	S21-8		
	* FA VERSION NEEDED TO INTERCHANGE								
PAGE 74	AG PUSH/PULL INTERCHANGEABLE FEMALE/SOCKET								
800401002	F. IRS 12 VA NPT				4250-4P		S45-4P		
800301002	F. IRS 12A NPT				4250-4		S45-4		
800401004	F. IRS 12VA PC NPT				8250-4		S75-4		
PAGE 76	WING STYLE INTERCHANGEABLE FEMALE / SOCKET								
100610012	F. W6F6-B	5100-S5-12B	FB-12/34-NPT-F-5	96-S31	6125-12	6WF6-B	S515W-6	B78C-12-12-F	51W-12
100610016	F. W8F8-B	5100-S5-16B	FB-16/1-NPT-F-5	96-S36	6125-16	8WF-B	S515W-8	B78C-16-16-F	51W-16
100610020	F. 10WF10-B	5100-S5-20B	FB-20/114-NPT-F-5	96-S41	6125-20	10WF10-B	S515W-10	B78C-20-20-F	51W-20
PAGE 76	FEMALE / SOCKET								
100610112	M. W6F6-B	5100-S2-12B	FB-12/34-NPT-M-5	96-P31	6105-12	W6F6-B	S511W-6	B78N-12-12-F	51P-12
100610116	M. W8F8-B	5100-S2-16B	FB-16/1-NPT-M-5	96-P36	6105-16	W8F8-B	S511W-8	B78N-16-16-F	51P-16
100610120	M. W10F10-B	5100-S2-20B	FB-20/114-NPT-M-5	96-P41	6105-20	W10F10-B	S511W-10	B78N-20-20-F	51P-20



# Coupler ID Chart

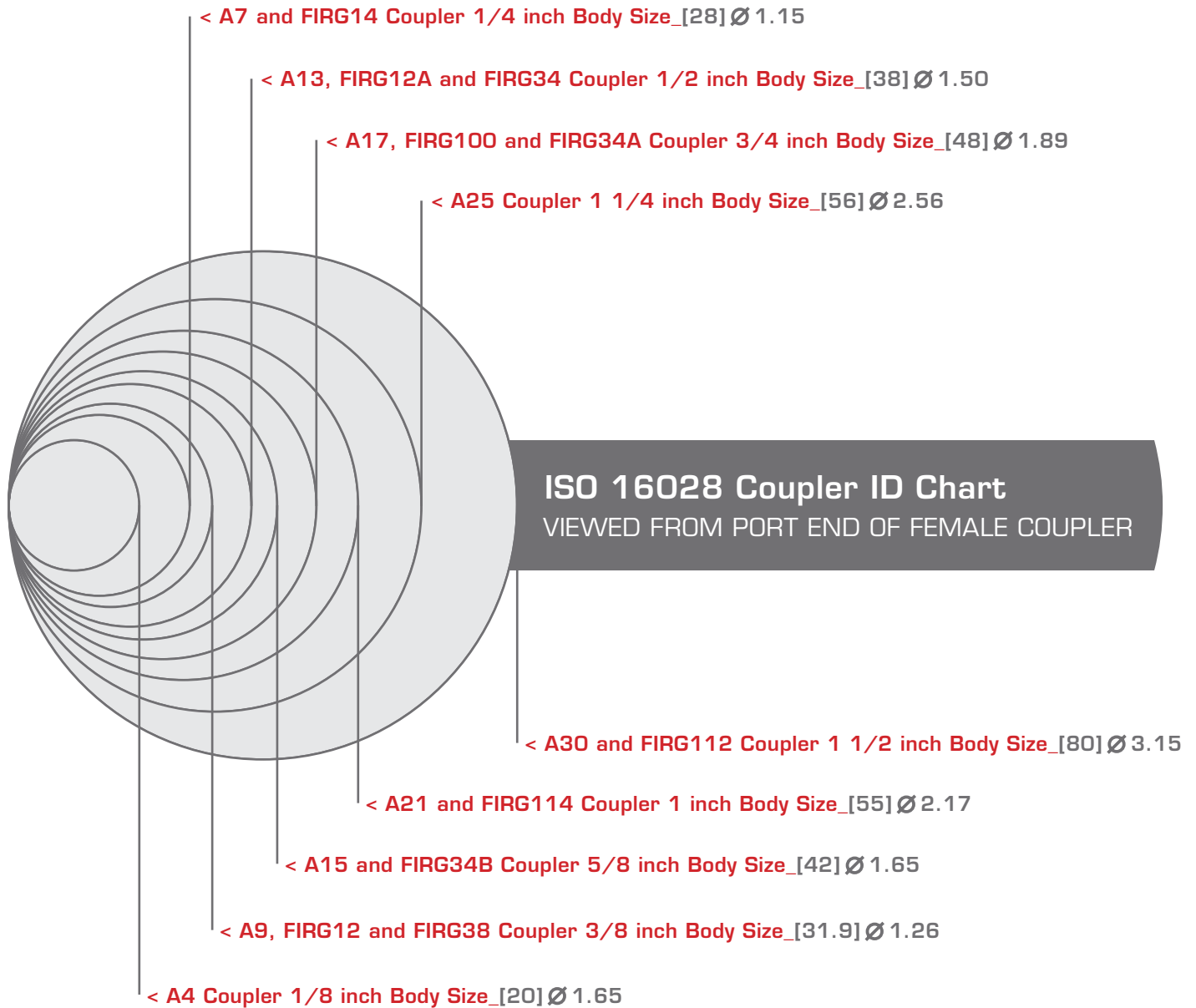

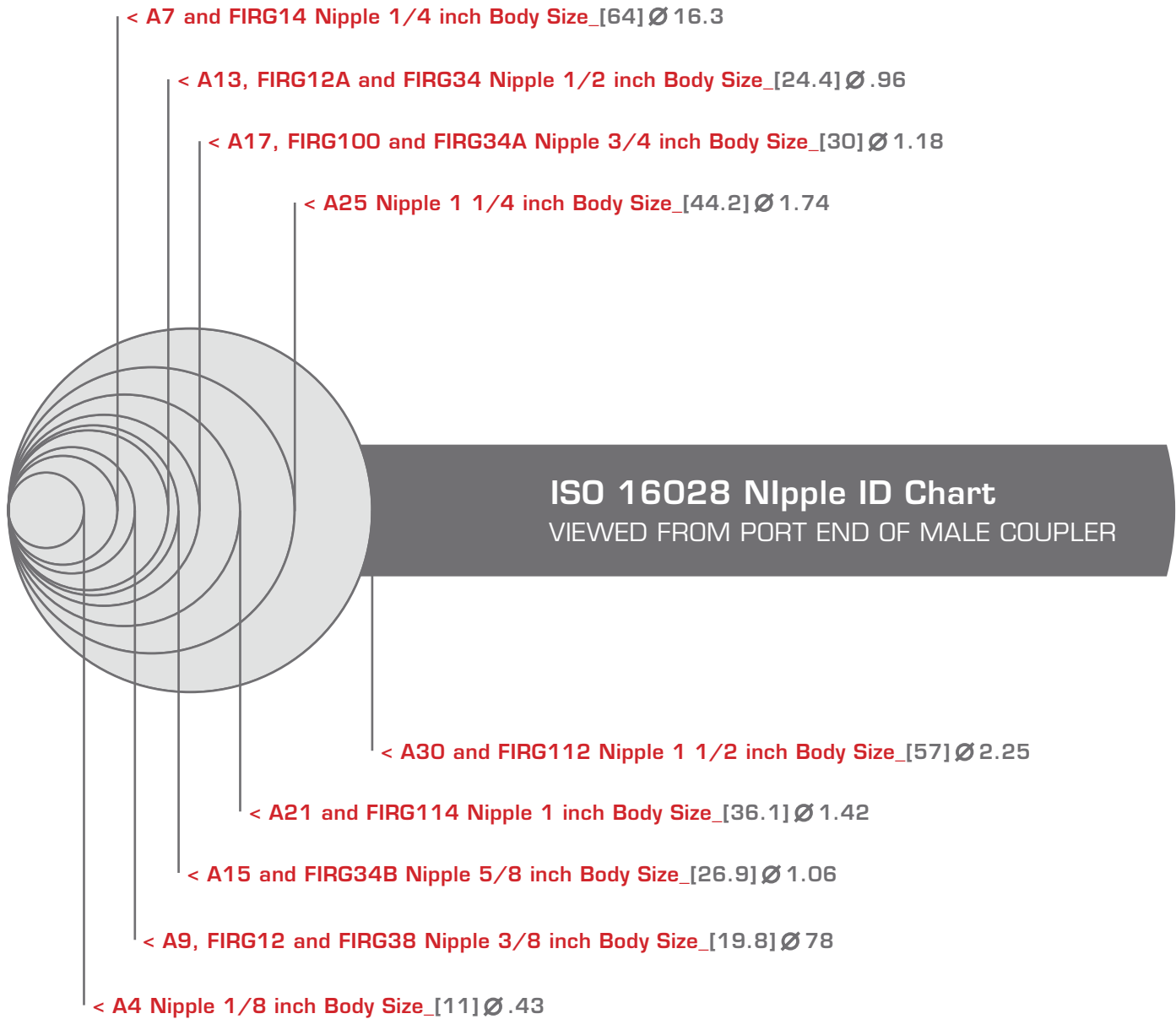

## Printed Collateral: Available Brochures



< FULL PRODUCT LINE BROCHURE  
CK201001

30X60 INCH CANVAS BANNER  
CB30X60



### MAIN LINE PRODUCT BROCHURES

THREADED FLAT FACE COUPLINGS  
CK201002

MULTI-COUPLING PLATES  
CK201003

SATURN BLOCK  
CK201004



## Point of Purchase: Available Displays



MULTI-COUPLING PLATE AND  
SATURN BLOCK DISPLAY UNIT  
POPDEMO-DPSB



SATURN BLOCK DISPLAY UNIT  
POP119SBC



# Stucchi<sup>®</sup>



Stucchi | 1107 Windham Parkway | Romeoville, IL 60446 USA | 847.956.9720 | fax 847.956.9723 | [www.stucchiusa.com](http://www.stucchiusa.com)  
Stucchi Inc, Canada Warehouse | 6300 Viscount Road, Unit 1A | Mississauga, ON L4V 1H3