

Accessories

Protective guards and sleeves

Spring guards	K-2
Poly hose guard	K-3
Abrasion sleeve	K-3
Locator clamps	K-3
Hose bend restrictors	K-4
Firesleeve	K-4
Firesleeve tape	K-4
Guardian sleeve	K-5
Support clamp	K-6

Accessories to hose chart **K-7**

Ready-made hose assemblies

Air brake coil	K-16
Air compressor	K-17
Grease hose whip ends	K-18
Power trim	K-18
Air brake air chamber	K-19

Automotive, light truck gas/oil	K-20
Automotive, light truck universal-type filter	K-21

Hose assembly

Hose insertion gauge	K-22
Pressure gauge kit	K-22

Hose protection

Hose spacers	K-23
Hose protectors	K-23
Flaretite seals	K-24
Bundling sleeves	K-25
Bundling straps	K-26

Hose clamps

Round-wire clamps	K-28
E.F.I. hose clamp	K-28
Heavy-duty support clamps	K-28
Stainless steel band clamps	K-29

K



Accessories

Protective guards and sleeves

K

Round-wire spring guard

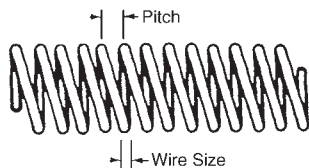
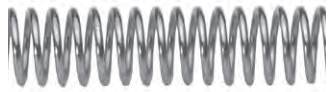

Spring guards should be considered for applications that call for tough, steel armor protection. They offer heavy-duty defense against cuts and abrasion, with the added benefit of kink resistance and the ability to mold hose assembly routing for applications requiring tight bends. Round-wire spring guards can be welded together for longer lengths.

Construction

Hot dipped Galvanized steel, chemically treated and oiled

Guard I.D.	Part Number	Package Length (ft)	Wire Diameter	Pitch
0.532	A1900	100	0.063	0.188
0.532	A1900-20	20	0.063	0.188
0.532	A1901	100	0.063	0.188
0.532	A1901-20	20	0.063	0.188
0.610	A1902	100	0.063	0.188
0.610	A1902-20	20	0.063	0.188
0.660	A1903	100	0.080	0.188
0.660	A1903-20	20	0.080	0.188
0.750	A1904	100	0.080	0.188
0.750	A1904-20	20	0.080	0.188
0.840	A1905	100	0.080	0.188
0.840	A1905-20	20	0.080	0.188
0.910	A1906	100	0.080	0.188
0.910	A1906-20	20	0.080	0.188
0.990	A1907	100	0.080	0.188
0.990	A1907-20	20	0.080	0.188
1.048	A1908	100	0.080	0.188
1.048	A1908-20	20	0.080	0.188
1.340	A1912	60	0.105	0.375
1.642	A1913	60	0.120	0.375
1.880	A1916	60	0.120	0.375
2.125	A1917	40	0.120	0.375
2.300	A1919	40	0.120	0.375

Flat-wire spring guard

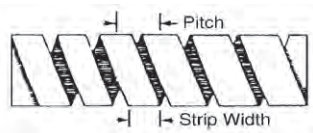

Spring guards should be considered for applications that call for tough, steel armor protection. They offer heavy-duty defense against cuts and abrasion, with the added benefit of kink resistance and the ability to mold hose assembly routing for applications requiring tight bends.

Construction

1/4" width Galvanized steel

Guard I.D.	Part Number	Package Length (ft)	Strip Thickness	Strip Width	Pitch
0.500	A2900	100	0.028	0.250	0.37
0.570	A2901	100	0.028	0.250	0.37
0.625	A2902	100	0.028	0.250	0.37
0.750	A2904	100	0.028	0.250	0.37
0.875	A2905	100	0.028	0.250	0.37
0.900	A2906	100	0.028	0.500	0.69
0.990	A2907	100	0.028	0.500	0.69
1.031	A2908	100	0.028	0.500	0.69
1.110	A2909	100	0.028	0.500	0.69
1.219	A2910	100	0.028	0.500	0.69
1.300	A2911	60	0.028	0.500	0.69
1.380	A2912	60	0.028	0.500	0.81
1.630	A2913	60	0.028	0.500	0.81
2.130	A2917	40	0.028	0.500	0.81
2.300	A2919	40	0.028	0.500	0.81

Heavy-duty poly hose guard



A heavy-duty hose guard can be easily placed around a single or bundle of hydraulic and pneumatic hose. It protects against abrasion and also provides crush resistance, reducing or eliminating costly premature hose failures.

Construction: High density Polyethylene

Operating temperature range

-100°F to +220°F

Color Black

Guard I.D.	Part Number	Wall Thickness	Guard O.D.	Roll Length(ft)
0.492	A9900	.069	.630	100
0.668	A9901	.086	.840	100
1.014	A9902	.118	1.250	100
1.600	A9903	.150	1.900	50
2.457	A9904	.209	2.875	50
3.065	A9905	.218	3.500	35

Benefits

Resists oils, lubricants, gasoline and most solvents.

Abrasion sleeve

MSHA Accepted ISO 6945



Abrasion sleeve is used to help safeguard hose covers from abrasions and cuts. The sleeve is also useful for bundling two or more hose assemblies together, adding to its protective qualities.

It is available in .045" thin-wall and .090" thick-wall sleeving.

Sleeve I.D.	.045" Thin Wall Part No.	.090" Thick Wall Part No.	Package Length* (ft)	Flat I.D.
0.90	A4900	A3900	100	1.32-1.51
1.06	A4901	A3901	100	1.57-1.76
1.22	A4902	A3902	100	1.82-2.01
1.35	A4903	A3903	100	2.03-2.21
1.66	A4904	A3904	100	2.63-2.87
1.81	A4905	A3905	100	2.75-2.94
2.19	A4906	A3906	100	3.43-3.53
2.62	A4907	A3907	100	4.02-4.21
2.80	A4908	A3908	100	4.43-4.62

*Package contains two pieces that are not less than 30 feet long each.

Note: Wall thickness is for single wall.

Note: Abrasion sleeve temp rating is 250°F.

Construction

Bulk continuous filament nylon

* Slide sleeve onto the hose before assembling the fittings. After assembly, clamp the sleeve over the fittings.

Application

- Agriculture
- Logging
- Construction
- Mining

Locator clamps

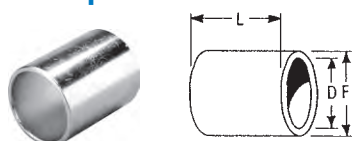

Locator clamps are designed for crimping to H14510 or H42510 hydraulic hose to provide a support for routing clamps. They are popular in Case® equipment applications.

Note: Crimp using collet T-400-5C and spacer ring T-400-62 (yellow), flat side up.

Hose I.D.	Part Number	L	D	F
5/8	A4910	1.60	1.084	1.25

Accessories

Protective guards and sleeves

K

Hose bend restrictors



For use in protecting the last section of hose at the fitting connection, bend restrictors are designed to allow for an appropriate degree of “bend” without compromising the integrity of hose assemblies. They are also recommended for hose assemblies that receive substantial handling, such as in pressure washer, air, oil, and hydraulic fluid transfer applications.

Construction

Plastisol MR 436 gloss PVC

Note: Colors red, blue, green and yellow available by special order.

Restrictor I.D.	Part Number	Restrictor Length (Inch)	Hose type application
0.530	A5953	6	H14504, H00904
0.625	A5962	6	H10404, H20906, H24504, H34504, H42504
0.690	A5969	6	H14506, H34506
0.750	A5975	7	H10406, H20908, H24506, H30006
0.840	A5984	7	H10408, H14508, H24508
0.875	A5987	7	H34508

Firesleeve



Firesleeve is a flame-resistant sheathing constructed of tightly woven fiberglass, which is coated with a specially compounded, highly temperature-resistant silicone rubber. Firesleeve offers protection in high temperature environments with heat extremes. It is not compatible with hydrocarbons.

Temperature range

Continuous exposure up to 500°F

Up to 2000°F for 15 to 20 minutes

Up to 3000°F for durations of 15 to 30 seconds

Color Red-orange

Sleeve I.D.	Part Number	Roll Length (ft)
0.50	A6908	100
0.63	A6910	100
0.75	A6912	100
0.88	A6914	100
1.00	A6916	100
1.25	A6920	100
1.50	A6924	100
1.75	A6928	100
2.00	A6932	50
2.25	A6936	50
3.00	A6948	50

Firesleeve tape

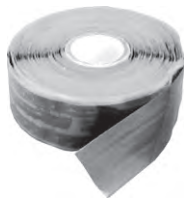

CAUTION

Tests should be conducted to determine the suitability of Firesleeve for each application.

Tape Coverage	Part Number	Roll Length
All sizes	A6900W	1x432

Firesleeve tape provides protection in high temperature environments. It acts as an end sealant in preventing moisture and hydraulic oils from wicking into the inner braids of Firesleeve.

Construction

High temperature-resistant, non-adhesive, silicone elastomer

Operating temperature

+475°F continuous

Guardian sleeve

FF90754

Eaton's Guardian sleeve is designed to provide protection against hydraulic hose failure by containing pressure and fluids that may escape during a hose burst or pinhole leak. With this new line of sight sleeving which meets industry standards, both equipment operators and the environment are guarded from the effects of hose failures.

Properties	Specification	Description
Burst pressure	16,000 psi	Capable to contain hose burst up to 16,000 psi
Pin hole leak pressure	4,000 psi	Sustained 4,000 psi pin hole deflection from focused 1mm pin hole
Abrasion cycles	250,000	Holds up to 250,000 abrasion cycles per ISO 6945

General and dimensional information

Part number	Nominal I.D. (in)	A - Flat Width (in) +/- 0.125	Weights in lbs per 300 ft Roll	Rolls per box
FF90754-68	0.68	1.290	7.43	8
FF90754-79	0.79	1.400	8.50	7
FF90754-91	0.91	1.590	9.70	6
FF90754-98	0.98	1.590	10.13	6
FF90754-106	1.06	1.825	11.10	5
FF90754-122	1.22	2.076	12.60	4
FF90754-142	1.42	2.390	14.50	4
FF90754-157	1.57	2.650	16.10	3
FF90754-173	1.73	2.910	17.70	3
FF90754-185	1.85	3.100	18.80	3
FF90754-209	2.09	3.470	21.10	2
FF90754-219	2.19	3.630	22.10	2
FF90754-238	2.38	3.925	23.90	2
FF90754-288	2.88	4.714	28.60	2
FF90754-366	3.66	5.938	36.10	1

Guardian sleeve selection chart

Suggested sleeve Part number	Sleeve I.D. (in)	Max hose OD that sleeve can accept (in)	Hose size as a ref.
FF90754-68	0.68	0.52	-4
FF90754-79	0.79	0.61	-4
FF90754-91	0.91	0.70	-6
FF90754-98	0.98	0.76	-6
FF90754-106	1.06	0.80	-6
FF90754-122	1.22	0.92	-8
FF90754-142	1.42	1.02	10
FF90754-157	1.57	1.13	10
FF90754-173	1.73	1.24	12
FF90754-185	1.85	1.34	16
FF90754-209	2.09	1.50	16
FF90754-219	2.19	1.54	20
FF90754-238	2.38	1.70	20
FF90754-288	2.88	2.00	20
FF90754-366	3.66	2.40	24



Construction: Denier: 1260

Melting Point: 215°C/420°F

Material: Polyamide 6, made with pre-dyed yarn

Dim. stability: Great resistance to sun, atmospheric agents and aging

Toxicity: Non-Toxic

Color: Black

Packing Requirements: Eaton Guardian Sleeve comes in a 300 foot roll with no more than 3 cuts per roll and no piece shorter than 30 feet.

Note: Must be ordered by the roll.

Guardian sleeve chemical compatibility

Chemical	Compatibility
Gasoline	Very Good
Oil	Very Good
Mineral and Vegetable Oil	Very Good
Ionic Metallic Solutions	Very Good
Alcohols	Very Good
Diluted Bases	Very Good
Diluted acids *	Good
Benzene	Very Good
Acetone	Very Good
Ether	Very Good
Carbon Tetrachloride	Very Good
Chlorine Based Solvent	Very Good
Mold, Bacteria, Moths	Very Good

*Strong and concentrated acids; ie. HCL or Formic Acid may have some corrosive action.

Assembly instructions

1. Select the correct sleeve part number for the hose.
2. Cut the sleeve 2 inches longer than the cut length of the hose to allow full hose bend radius.
3. The ends of the sleeves must be seared to prevent sleeve from fraying.
4. Slide the sleeve over the hose.
5. Properly assemble the hose ends.
6. Secure the sleeve over hose sockets with a metal banding product.

Features / Benefits

- The ultra tight weave resists oil spillage from hose failure
- Densely twisted polyamide resists wear
- 6 yarn offers optimum UV and abrasion protection
- Meets ASTM D6770 for abrasion resistance of textile webbing
- Meets abrasion standard ISO 6945
- Meets Fed-STD191-Test Method 5309 for abrasion
- Meets conductivity requirements of ISO 8031
- MSHA approved #IC-234/0
- Meets standard application procedures for acceptance of Flame Resistance Solid Products taken into mines

Accessories

Protective guards and sleeves

K

Hose support clamps

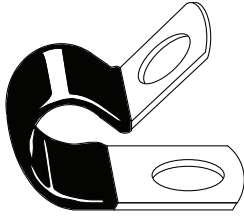









Support for long hose length to ensure proper hose routing in applications in which abrasion, moving parts, or heat are present.

Construction

C1010 steel with 1/32" thick black vinyl cushion, Zinc-plated

Note: Vinyl coating will withstand 300°F for 2 hours or 180°F for 2000 hours.

Clamping diameter	Part number	Bolt hole
1/4	HK0509	13/32
3/8	HK0709	13/32
7/16	HK0809	13/32
1/2	HK0913	13/32
9/16	HK1013	13/32
5/8	HK1113	13/32
11/16	HK1213	13/32
3/4	HK1313	13/32
13/16	HK1413	13/32
7/8	HK1513	13/32
15/16	HK1613	13/32
1	HK1713	13/32
1-1/16	HK1813	13/32
1-1/8	HK1913	17/32
1-3/16	HK2017	17/32
1-1/4	HK2117	17/32
1-3/8	HK2317	17/32
1-1/2	HK2517	17/32
1-9/16	HK2617	17/32
1-3/4	HK2917	17/32
1-7/8	HK3117	17/32
1-15/16	HK3217	17/32
2	HK3317	17/32
2-1/8	HK3417	17/32
2-5/8	HK3817	17/32









Hose Type	Dash Size	Hose clamp	Round-wire spring guard	Flat-wire spring guard	Nylon(.045) abrasion sleeve	Nylon (.090) abrasion sleeve	Silicone fiberglass Firesleeve	Poly hose guard	Guardian sleeve
									
H009	4	HK1013	A1901	A2901	A4900	A3900	A6910	A9901	FF90754-79
	5	HK1113	A1902	A2902	A4900	A3900	A6910	A9901	FF90754-79
	6	HK1213	A1903	A2904	A4900	A3900	A6912	A9901	FF90754-91
	8	HK1413	A1905	A2905	A4900	A3900	A6914	A9902	FF90754-122
H039	12	HK2317	A1912	A2911	A4903	A3903	A6924	A9903	FF90754-185
	16	HK2617	A1913	A2913	A4904	A3904	A6928	A9903	FF90754-219
	20	HK3117	A1916	A2917	A4906	A3906	A6932	A9904	FF90754-288
	24	HK3417	A1917	A2917	A4906	A3906	A6936	A9904	FF90754-366
H039H	32	HK3817	—	—	A4907	A3907	A6948	A9905	—
	12	HK2317	A1912	A2911	A4903	A3903	A6924	A9903	FF90754-185
	16	HK2617	A1913	A2913	A4904	A3904	A6928	A9903	FF90754-219
	20	HK3117	A1916	A2917	A4906	A3906	A6932	A9904	FF90754-288
H057	24	HK3417	A1917	A2917	A4906	A3906	A6936	A9904	FF90754-366
	32	HK3817	—	—	A4907	A3907	A6948	A9905	—
	3	HK0809	A1901	A2900	A4900	A3900	A6908	A9900	FF90754-68
	4	HK1013	A1901	A2901	A4900	A3900	A6910	A9901	FF90754-79
H059	5	HK1113	A1902	A2902	A4900	A3900	A6910	A9901	FF90754-79
	6	HK1213	A1903	A2904	A4900	A3900	A6912	A9901	FF90754-91
	4	HK1013	A1901	A2901	A4900	A3900	A6910	A9901	FF90754-79
	5	HK1113	A1902	A2902	A4900	A3900	A6910	A9901	FF90754-79
	6	HK1313	A1904	A2904	A4901	A3901	A6912	A9902	FF90754-98
	8	HK1413	A1905	A2905	A4901	A3901	A6914	A9902	FF90754-106
	10	HK1713	A1907	A2907	A4901	A3901	A6916	A9902	FF90754-142
12	HK1913	A1910	A2909	A4902	A3902	A6920	A9903	FF90754-173	
H069	16	HK2317	A1912	A2911	A4903	A3903	A6924	A9903	FF90754-185
	4	HK1013	A1902	A2901	A4900	A3900	A6910	A9901	FF90754-79
	5	HK1113	A1902	A2902	A4900	A3900	A6910	A9901	FF90754-79
	6	HK1313	A1904	A2904	A4900	A3900	A6912	A9902	FF90754-98
	8	HK1413	A1905	A2905	A4900	A3900	A6914	A9902	FF90754-106
	10	HK1713	A1907	A2907	A4901	A3901	A6916	A9902	FF90754-142
	12	HK1913	A1910	A2909	A4902	A3902	A6920	A9903	FF90754-157
	16	HK2317	A1912	A2911	A4903	A3903	A6924	A9903	FF90754-185
	20	HK2617	A1913	A2913	A4904	A3904	A6928	A9903	FF90754-219
	24	HK3117	A1916	A2917	A4905	A3905	A6932	A9904	FF90754-288
H100	32	HK3817	A1919	A2919	A4907	A3907	A6948	A9904	FF90754-366
	40	—	—	—	—	—	A6948	A9905	—
	4	HK1013	A1901	A2901	A4900	A3900	A6910	A9901	FF90754-79
	5	HK1013	A1902	A2901	A4900	A3900	A6910	A9901	FF90754-79
	6	HK1213	A1903	A2904	A4900	A3900	A6912	A9901	FF90754-91
	8	HK1413	A1905	A2905	A4900	A3900	A6914	A9902	FF90754-106
H100	10	HK1713	A1907	A2907	A4901	A3901	A6916	A9902	FF90754-142
	12	HK1813	A1912	A2909	A4902	A3902	A6920	A9903	FF90754-157

*Sizes indicated are based on Hose O.D. only. If sleeve is to be placed over fittings, a larger sleeve size may be required, depending on type of fitting used.









Accessories

Accessories to hose chart

K

Hose Type	Dash Size	Hose clamp	Round-wire spring guard	Flat-wire spring guard	Nylon(.045) abrasion sleeve	Nylon (.090) abrasion sleeve	Silicone fiberglass Firesleeve	Poly hose guard	Guardian sleeve
									
H101	4	HK1013	A1901	A2901	A4900	A3900	A6910	A9901	FF90754-79
	5	HK1013	A1902	A2901	A4900	A3900	A6910	A9901	FF90754-79
	6	HK1213	A1903	A2904	A4900	A3900	A6912	A9901	FF90754-91
	8	HK1413	A1905	A2905	A4900	A3900	A6914	A9902	FF90754-106
	10	HK1713	A1907	A2907	A4901	A3901	A6916	A9902	FF90754-142
	12	HK1813	A1912	A2909	A4902	A3902	A6920	A9903	FF90754-157
H1015	4	HK1113	A1903	A2904	A4900	A3900	A6910	A9901	FF90754-91
	6	HK1313	A1904	A2904	A4900	A3900	A6912	A9902	FF90754-98
	8	HK1513	A1906	A2906	A4900	A3900	A6914	A9902	FF90754-122
	10	HK1813	A1908	A2908	A4901	A3901	A6920	A9902	FF90754-142
	12	HK2017	A1912	A2910	A4902	A3902	A6920	A9903	FF90754-173
	16	HK2517	A1913	A2912	A4904	A3904	A6924	A9903	FF90754-209
	20	HK3117	A1916	A2917	A4905	A3905	A6932	A9904	FF90754-288
	24	HK3417	A1917	A2917	A4906	A3906	A6936	A9904	FF90754-366
H145	4	HK1013	A1901	A2901	A4900	A3900	A6910	A9901	FF90754-68
	6	HK1213	A1903	A2904	A4900	A3900	A6912	A9901	FF90754-91
	8	HK1413	A1905	A2905	A4900	A3900	A6914	A9902	FF90754-122
	10	HK1713	A1907	A2908	A4901	A3901	A6916	A9902	FF90754-142
	12	HK2017	A1912	A2910	A4902	A3902	A6920	A9903	FF90754-173
	16	HK2517	A1913	A2913	A4904	A3904	A6924	A9903	FF90754-209
H145R	4	HK1013	A1901	A2901	A4900	A3900	A6910	A9901	FF90754-68
	6	HK1213	A1904	A2904	A4900	A3900	A6912	A9901	FF90754-91
	8	HK1413	A1905	A2905	A4900	A3900	A6914	A9902	FF90754-122
	10	HK1713	A1908	A2908	A4901	A4901	A6916	A9902	FF90754-142
	12	HK2017	A1912	A2910	A4902	A3902	A6920	A9903	FF90754-173
	16	HK2517	A1913	A2913	A4904	A3904	A6924	A9903	FF90754-209
H166	4	HK1013	A1902	A2901	A4900	A3900	A6910	A9901	FF90754-79
	5	HK1113	A1902	A2902	A4900	A3900	A6910	A9901	FF90754-79
	6	HK1313	A1904	A2904	A4900	A3900	A6912	A9902	FF90754-98
	8	HK1413	A1905	A2905	A4900	A3900	A6914	A9902	FF90754-106
	10	HK1713	A1907	A2907	A4901	A3901	A6916	A9902	FF90754-142
	12	HK1913	A1910	A2910	A4902	A3902	A6920	A9903	FF90754-157
	16	HK2317	A1912	A2911	A4903	A3903	A6924	A9903	FF90754-185
	20	HK2617	A1913	A2913	A4904	A3904	A6928	A9903	FF90754-219
H169	6	HK1313	A1904	A2904	A4900	A3900	A6912	A9902	FF90754-91
	8	HK1413	A1905	A2905	A4900	A3900	A6914	A9902	FF90754-106
	10	HK1713	A1907	A2907	A4901	A3901	A6916	A9902	FF90754-142
	12	HK1913	A1912	A2910	A4902	A3902	A6920	A9903	FF90754-157
	16	HK2317	A1912	A2911	A4903	A3903	A6924	A9903	FF90754-185
	20	HK2617	A1913	A2913	A4904	A3904	A6928	A9903	FF90754-219
	24	HK3117	A1916	A2917	A4905	A3905	A6932	A9904	FF90754-288
32	HK3817	A1919	A2919	A4907	A3907	A6948	A9904	FF90754-366	

*Sizes indicated are based on Hose O.D. only. If sleeve is to be placed over fittings, a larger sleeve size may be required, depending on type of fitting used.









Hose Type	Dash Size	Hose clamp	Round-wire spring guard	Flat-wire spring guard	Nylon(.045) abrasion sleeve	Nylon (.090) abrasion sleeve	Silicone fiberglass Firesleeve	Poly hose guard	Guardian sleeve
									
H180	4	HK1013	A1901	A2901	A4900	A3900	A6910	A9901	FF90754-79
	6	HK1213	A1903	A2904	A4900	A3900	A6912	A9901	FF90754-91
	8	HK1413	A1905	A2905	A4900	A3900	A6914	A9902	FF90754-106
	10	HK1613	A1906	A2907	A4901	A3901	A6916	A9902	FF90754-122
	12	HK1813	A1908	A2908	A4901	A3901	A6920	A9903	FF90754-157
	16	HK2317	A1913	A2912	A4904	A3904	A6924	A9903	FF90754-209
	20	HK2917	A1913	A2917	A4905	A3905	A6928	A9904	FF90754-238
	24	HK3217	A1917	A2917	A4906	A3906	A6932	A9904	FF90754-288
	32	HK3817	—	—	A4907	A3907	A6948	A9905	—
H190	4	HK1013	A1902	A2901	A4900	A3900	A6910	A9901	FF90754-79
	6	HK1313	A1904	A2904	A4900	A3900	A6912	A9902	FF90754-91
	8	HK1413	A1905	A2905	A4900	A3900	A6914	A9902	FF90754-122
	10	HK1713	A1907	A2907	A4901	A3901	A6916	A9902	FF90754-142
	12	HK1913	A1912	A2909	A4902	A3902	A6920	A9903	FF90754-157
	16	HK2517	A1913	A2913	A4904	A3904	A6924	A9903	FF90754-209
	20	HK2917	A1916	A2917	A4905	A3905	A6928	A9904	FF90754-288
	24	HK3317	A1917	A2917	A4906	A3906	A6932	A9904	FF90754-288
	32	HK3817	—	—	A4907	A3907	A6948	A9905	—
H190H	4	HK1013	A1902	A2901	A4900	A3900	A6910	A9901	FF90754-79
	6	HK1313	A1904	A2904	A4900	A3900	A6912	A9902	FF90754-91
	8	HK1413	A1905	A2905	A4900	A3900	A6914	A9902	FF90754-122
	10	HK1713	A1907	A2907	A4901	A3901	A6916	A9902	FF90754-142
	12	HK1913	A1912	A2909	A4902	A3902	A6920	A9903	FF90754-157
	16	HK2517	A1913	A2913	A4904	A3904	A6924	A9903	FF90754-209
	20	HK2917	A1916	A2917	A4905	A3905	A6928	A9904	FF90754-288
	24	HK3417	A1917	A2917	A4906	A3906	A6936	A9904	FF90754-288
	32	HK3817	—	—	A4907	A3907	A6948	A9905	—
H201	4	HK1013	A1901	A2901	A4900	A3900	A6910	A9901	FF90754-79
	5	HK1113	A1902	A2902	A4900	A3900	A6910	A9901	FF90754-79
	6	HK1313	A1904	A2904	A4900	A3900	A6912	A9902	FF90754-91
	8	HK1413	A1905	A2905	A4900	A3900	A6914	A9902	FF90754-106
	10	HK1713	A1907	A2907	A4901	A3901	A6916	A9902	FF90754-142
	12	HK1913	A1912	A2909	A4902	A3902	A6920	A9903	FF90754-157
	16	HK2517	A1913	A2913	A4904	A3904	A6924	A9903	FF90754-209
H209	4	HK0913	A1901	A2900	A4900	A3900	A6908	A9900	FF90754-68
	6	HK1013	A1902	A2901	A4900	A3900	A6910	A9901	FF90754-79
	8	HK1313	A1904	A2904	A4900	A3900	A6912	A9902	FF90754-98
H213	4	HK1013	A1901	A2901	A4900	A3900	A6910	A9901	FF90754-68
	5	HK1113	A1902	A2902	A4900	A3900	A6910	A9901	FF90754-79
	6	HK1213	A1903	A2904	A4900	A3900	A6912	A9901	FF90754-91
	8	HK1413	A1905	A2905	A4900	A3900	A6914	A9902	FF90754-98
	10	HK1513	A1906	A2905	A4900	A3900	A6914	A9902	FF90754-122
	12	HK1713	A1907	A2907	A4901	A3901	A6916	A9902	FF90754-142
	16	HK2117	A1912	A2911	A4903	A3903	A6920	A9903	FF90754-173

*Sizes indicated are based on Hose O.D. only. If sleeve is to be placed over fittings, a larger sleeve size may be required, depending on type of fitting used.









Accessories

Accessories to hose chart

K

Hose Type	Dash Size	Hose clamp	Round-wire spring guard	Flat-wire spring guard	Nylon(.045) abrasion sleeve	Nylon (.090) abrasion sleeve	Silicone fiberglass Firesleeve	Poly hose guard	Guardian sleeve
									
H229	4	HK1013	A1902	A2901	A4900	A3900	A6910	A9901	FF90754-79
	6	HK1413	A1905	A2905	A4900	A3900	A6914	A9902	FF90754-98
	8	HK1613	A1907	A2907	A4901	A3901	A6916	A9902	FF90754-122
	10	HK1813	A1908	A2908	A4901	A3901	A6920	A9903	FF90754-142
	12	HK2317	A1912	A2911	A4903	A3903	A6924	A9903	FF90754-185
H239	4	HK1013	A1902	A2901	A4900	A3900	A6910	A9901	FF90754-79
	6	HK1313	A1904	A2904	A4900	A3900	A6912	A9902	FF90754-98
	8	HK1413	A1905	A2905	A4900	A3900	A6914	A9902	FF90754-122
	10	HK1713	A1907	A2907	A4901	A3901	A6916	A9902	FF90754-142
	12	HK1813	A1908	A2908	A4901	A3901	A6920	A9903	FF90754-142
	16	HK2317	A1912	A2911	A4903	A3903	A6924	A9903	FF90754-185
	20	HK2617	A1913	A2913	A4904	A3904	A6928	A9903	FF90754-219
H243	3	HK0709	A1901	A2900	A4900	A3900	A6908	A9900	FF90754-68
	4	HK0709	A1901	A2900	A4900	A3900	A6908	A9900	FF90754-68
	5	HK0809	A1901	A2900	A4900	A3900	A6908	A9900	FF90754-68
	6	HK0913	A1901	A2901	A4900	A3900	A6910	A9901	FF90754-79
	8	HK1113	A1904	A2904	A4900	A3900	A6912	A9902	FF90754-91
	12	HK1513	A1907	A2907	A4901	A3901	A6916	A9902	FF90754-122
	16	HK1913	A1912	A2911	A4903	A3903	A6924	A9903	FF90754-185
H245L	4	HK1013	A1902	A2901	A4900	A3900	A6910	A9901	FF90754-79
	6	HK1213	A1904	A2904	A4900	A3900	A6912	A9902	FF90754-91
	8	HK1513	A1906	A2905	A4900	A3900	A6914	A9902	FF90754-122
	10	HK1713	A1908	A2908	A4901	A3901	A6916	A9902	FF90754-142
	12	HK1913	A1912	A2910	A4902	A3902	A6920	A9903	FF90754-157
	16	HK2517	A1912	A2913	A4904	A3904	A6924	A9903	FF90754-209
	20	HK2917	A1916	A2917	A4905	A3905	A2928	A9904	FF90754-288
	24	HK3417	A1917	A2917	A4906	A3906	A6936	A9904	FF90754-366
H275	32	HK3817	—	—	A4907	A3907	A6948	A9905	—
	4	HK0913	A1901	A2900	A4900	A3900	A6908	A9900	FF90754-68
	6	HK1213	A1903	A2904	A4900	A3900	A6912	A9901	FF90754-91
	8	HK1413	A1905	A2905	A4900	A3900	A6914	A9902	FF90754-106
	10	HK1613	A1907	A2907	A4901	A3901	A6916	A9902	FF90754-122
	12	HK1813	A1912	A2909	A4901	A3901	A6920	A9903	FF90754-157
	16	HK2317	A1912	A2912	A4903	A3903	A6924	A9903	FF90754-185
	20	HK2917	A1916	A2917	A4905	A3905	A6928	A9904	FF90754-288
H277	24	HK3317	A1917	A2917	A4906	A3906	A6932	A9904	FF90754-288
	32	HK3817	—	—	A4907	A3907	A6948	A9905	—
	3	HK0709	A1901	A2900	A4900	A3900	A6908	A9900	FF90754-68
	4	HK0809	A1901	A2900	A4900	A3900	A6908	A9900	FF90754-68
	5	HK0913	A1901	A2900	A4900	A3900	A6908	A9900	FF90754-68
	6	HK1013	A1902	A2901	A4900	A3900	A6910	A9901	FF90754-79
	8	HK1213	A1904	A2904	A4900	A3900	A6912	A9902	FF90754-91
	12	HK1613	A1907	A2907	A4901	A3901	A6916	A9902	FF90754-122
	16	HK2017	A1912	A2911	A4903	A3903	A6924	A9903	FF90754-185

*Sizes indicated are based on Hose O.D. only. If sleeve is to be placed over fittings, a larger sleeve size may be required, depending on type of fitting used.









Hose Type	Dash Size	Hose clamp	Round-wire spring guard	Flat-wire spring guard	Nylon(.045) abrasion sleeve	Nylon (.090) abrasion sleeve	Silicone fiberglass Firesleeve	Poly hose guard	Guardian sleeve
									
H280	4	HK1013	A1902	A2901	A4900	A3900	A6910	A9901	FF90754-79
	6	HK1313	A1904	A2904	A4900	A3900	A6912	A9902	FF90754-91
	8	HK1513	A1905	A2905	A4900	A3900	A6914	A9902	FF90754-122
	10	HK1713	A1907	A2907	A4901	A3901	A6916	A9902	FF90754-142
	12	HK1913	A1912	A2910	A4902	A3902	A6920	A9903	FF90754-157
	16	HK2517	A1913	A2913	A4904	A3904	A6924	A9903	FF90754-209
	20	HK2917	A1916	A2917	A4905	A3905	A6928	A9904	FF90754-288
	24	HK3417	A1917	A2917	A4906	A3906	A6936	A9904	FF90754-366
	32	HK3817	—	—	A4907	A3907	A6948	A9905	—
H285	3	HK0709	A1901	A2900	A4900	A3900	A6908	A9900	FF90754-68
	4	HK0913	A1901	A2900	A4900	A3900	A6908	A9900	FF90754-68
	5	HK1013	A1902	A2901	A4900	A3900	A6910	A9901	FF90754-79
	6	HK1113	A1902	A2902	A4900	A3900	A6910	A9901	FF90754-79
	8	HK1413	A1905	A2905	A4900	A3900	A6914	A9902	FF90754-98
	10	HK1513	A1906	A2905	A4900	A3900	A6914	A9902	FF90754-122
	12	HK1813	A1908	A2908	A4901	A3901	A6920	A9903	FF90754-157
	16	HK2317	A1912	A2912	A4903	A3903	A6924	A9903	FF90754-185
	20	HK2917	A1916	A2917	A4905	A3905	A6928	A9904	FF90754-238
	24	HK3317	A1917	A2917	A4906	A3906	A6932	A9904	FF90754-288
		32	HK3817	—	—	A4907	A3907	A6948	A9905
H290	4	HK1113	A1902	A2902	A4900	A3900	A6910	A9901	FF90754-79
	6	HK1413	A1905	A2905	A4900	A3900	A6914	A9902	FF90754-98
	8	HK1613	A1906	A2906	A4900	A3900	A6916	A9902	FF90754-122
	10	HK1813	A1908	A2908	A4901	A3901	A6920	A9902	FF90754-142
	12	HK2017	A1912	A2910	A4902	A3902	A6920	A9903	FF90754-173
	16	HK2617	A1913	A2913	A4904	A3904	A6928	A9903	FF90754-219
	20	HK3217	A1917	A2917	A4906	A3906	A6932	A9904	FF90754-288
	24	HK3817	A1919	A2919	A4906	A3906	A6936	A9904	FF90754-366
		32	HK3817	—	—	A4907	A3907	A6948	A9905
H290H	4	HK1113	A1902	A2902	A4900	A3900	A6912	A9901	FF90754-79
	6	HK1413	A1905	A2905	A4900	A3900	A6914	A9902	FF90754-98
	8	HK1513	A1906	A2905	A4900	A3900	A6924	A9902	FF90754-122
	10	HK1713	A1908	A2908	A4901	A3901	A6916	A9902	FF90754-142
	12	HK2017	A1912	A2910	A4902	A3902	A6920	A9903	FF90754-173
	16	HK2517	A1913	A2913	A4904	A3904	A6924	A9903	FF90754-209
	20	HK3217	A1917	A2917	A4906	A3906	A6932	A9904	FF90754-288
	24	HK3817	A1919	A2919	A4906	A3906	A6936	A9904	FF90754-366
		32	—	—	—	A4908	A3908	A6948	A9905
H332	4	HK1013	A1901	A2901	A4900	A3900	A6910	A9901	FF90754-79
	6	HK1213	A1903	A2904	A4900	A3900	A6912	A9901	FF90754-91
	8	HK1413	A1905	A2905	A4900	A3900	A6914	A9902	FF90754-106
	10	HK1713	A1907	A2907	A4901	A3901	A6916	A9902	FF90754-142
	12	HK1913	A1912	A2910	A4902	A3902	A6920	A9903	FF90754-157
H400	10	HK1013	A1908	A2908	A4901	A3901	A6920	A9903	FF90754-142
	12	HK1313	A1912	A2910	A4902	A3902	A6920	A9903	FF90754-173

*Sizes indicated are based on Hose O.D. only. If sleeve is to be placed over fittings, a larger sleeve size may be required, depending on type of fitting used.









Accessories

Accessories to hose chart

K

Hose Type	Dash Size	Hose clamp	Round-wire spring guard	Flat-wire spring guard	Nylon(.045) abrasion sleeve	Nylon (.090) abrasion sleeve	Silicone fiberglass Firesleeve	Poly hose guard	Guardian sleeve
									
H421	4	HK1013	A1902	A2901	A4900	A3900	A6910	A9901	FF90754-79
	6	HK1413	A1905	A2905	A4900	A3900	A6914	A9902	FF90754-91
H429	8	HK1313	A1904	A2904	A4900	A3900	A6912	A9902	FF90754-91
	10	HK1413	A1905	A2905	A4900	A3900	A6914	A9902	FF90754-106
H430	6	HK1413	A1905	A2905	A4900	A3900	A6914	A9902	FF90754-122
	8	HK1613	A1907	A2907	A4901	A3901	A6916	A9902	FF90754-142
	10	HK1913	A1912	A2909	A4902	A3902	A6920	A9903	FF90754-157
	12	HK2117	A1912	A2910	A4902	A3902	A6920	A9903	FF90754-173
	16	HK2517	A1913	A2913	A4904	A3904	A6924	A9903	FF90754-219
	20	HK3117	A1916	A2917	A4906	A3906	A6932	A9904	FF90754-288
	24	HK3417	A1917	A2917	A4906	A3906	A6936	A9904	FF90754-366
	32	—	—	—	A4908	A3908	A6948	A9905	—
H430R	6	HK1413	A1905	A2905	A4900	A3900	A6914	A9902	FF90754-122
	8	HK1613	A1907	A2907	A4901	A3901	A6916	A9902	FF90754-142
	10	HK1913	A1912	A2909	A4902	A3902	A6920	A9903	FF90754-157
	12	HK2117	A1912	A2910	A4902	A3902	A6920	A9903	FF90754-173
	16	HK2617	A1913	A2913	A4904	A3904	A6928	A9903	FF90754-219
	20	HK3117	A1916	A2917	A4906	A3906	A6932	A9904	FF90754-288
	24	HK3417	A1917	A2917	A4906	A3906	A6936	A9904	FF90754-366
	32	—	—	—	A4908	A3908	A6948	A9905	—
H464	12	HK2317	A1912	A2911	A4903	A3903	A6924	A9903	FF90754-185
	16	HK2617	A1913	A2913	A4904	A3904	A6928	A9903	FF90754-219
	20	HK3117	A1916	A2917	A4905	A3905	A6932	A9904	FF90754-288
	24	HK3417	A1917	A2917	A4906	A3906	A6936	A9904	FF90754-366
	32	—	—	—	A4908	A3908	A6948	A9905	—
H471	12	HK2117	A1912	A2911	A4903	A3903	A6924	A9903	FF90754-173
	16	HK2617	A1913	A2913	A4904	A3904	A6928	A9903	FF90754-219
	20	HK3117	A1916	A2917	A4906	A3906	A6932	A9904	FF90754-288
	24	HK3817	A1919	A2919	A4906	A3906	A6936	A9904	FF90754-366
	32	—	—	—	—	—	A6948	A9905	—
H545	4	HK1013	A1901	A2901	A4900	A3900	A6910	A9901	FF90754-79
	6	HK1213	A1903	A2904	A4900	A3900	A6912	A9901	FF90754-91
	8	HK1513	A1905	A2905	A4900	A3900	A6914	A9902	FF90754-122
	10	HK1713	A1907	A2907	A4901	A3901	A6916	A9902	FF90754-142
	12	HK2017	A1912	A2910	A4902	A3902	A6920	A9903	FF90754-173
	16	HK2517	A1913	A2913	A4904	A3904	A6924	A9903	FF90754-209
H569	4	HK1013	A1902	A2901	A4900	A3900	A6910	A9901	FF90754-79
	5	HK1113	A1902	A2902	A4900	A3900	A6910	A9901	FF90754-79
	6	HK1313	A1904	A2904	A4900	A3900	A6912	A9902	FF90754-98
	8	HK1413	A1905	A2905	A4900	A3900	A6914	A9902	FF90754-106
	10	HK1713	A1907	A2907	A4901	A3901	A6916	A9902	FF90754-142
	12	HK1913	A1912	A2910	A4902	A3902	A6920	A9903	FF90754-157
	16	HK2317	A1912	A2911	A4903	A3903	A6924	A9903	FF90754-185
20	HK2617	A1913	A2913	A4904	A3904	A6928	A9903	FF90754-219	

*Sizes indicated are based on Hose O.D. only. If sleeve is to be placed over fittings, a larger sleeve size may be required, depending on type of fitting used.









Hose Type	Dash Size	Hose clamp	Round-wire spring guard	Flat-wire spring guard	Nylon(.045) abrasion sleeve	Nylon (.090) abrasion sleeve	Silicone fiberglass Firesleeve	Poly hose guard	Guardian sleeve
									
H757	6	HK1113	A1902	A2902	A4900	A3900	A6910	A9901	FF90754-79
	8	HK1313	A1904	A2904	A4900	A3900	A6912	A9902	FF90754-98
	10	HK1413	A1905	A2905	A4900	A3900	A6914	A9902	FF90754-106
	12	HK1713	A1907	A2907	A4901	A3901	A6916	A9902	FF90754-142
EC038	4	HK1213	A1904	A2904	A4900	A3900	A6912	A9902	FF90754-91
	6	HK1413	A1905	A2905	A4900	A3900	A6914	A9902	FF90754-106
	8	HK1613	A1907	A2907	A4901	A3901	A6916	A9902	FF90754-122
EC810	12	HK2117	A1912	A2912	A4905	A3905	A6928	A9903	FF90754-142
	16	HK2517	A1913	A2913	A4906	A3906	A6936	A9903	FF90754-157
	20	HK3317	A1917	A2917	A4906	A3906	A6932	A9904	FF90754-209
	24	HK3817	A1919	A2919	A4907	A3907	A6948	A9904	FF90754-238
	32	—	—	—	A4908	A3908	A6948	A9905	FF90754-288
EC910	8	HK1713	A1908	A2908	A4901	A3901	A6920	A9902	FF90754-142
	12	HK2317	A1912	A2912	A4903	A3903	A6924	A9903	FF90754-185
	13	HK2917	A1913	A2913	A4904	A3904	A6928	A9903	FF90754-238
H0106	4	HK1013	A1902	A2901	A4900	A3900	A6910	A9901	FF90754-79
	5	HK1213	A1904	A2904	A4900	A3900	A6912	A9901	FF90754-91
	6	HK1313	A1905	A2904	A4900	A3900	A6912	A9902	FF90754-98
	8	HK1513	A1906	A2905	A4900	A3900	A6914	A9902	FF90754-122
	10	HK1713	A1908	A2907	A4901	A3901	A6916	A9902	FF90754-142
	12	HK2017	A1912	A2910	A4902	A3902	A6920	A9903	FF90754-173
H1719	10	HK1513	A1906	A2905	A4900	A3900	A6914	A9902	FF90754-122
	12	HK1813	A1912	A2909	A4902	A3902	A6920	A9903	FF90754-157
H1776	4	HK1113	A1903	A2902	A4900	A3900	A6910	A9901	FF90754-79
	6	HK1313	A1904	A2904	A4900	A3900	A6912	A9902	FF90754-98
	8	HK1613	A1906	A2906	A4901	A3901	A6916	A9902	FF90754-122
	10	HK1713	A1908	A2908	A4901	A3901	A6920	A9902	FF90754-142
	12	HK2017	A1912	A2910	A4902	A3902	A6920	A9903	FF90754-173
	16	HK2517	A1913	A2913	A4904	A3904	A6924	A9903	FF90754-209
	20	HK2917	A1916	A2917	A4905	A3905	A6932	A9904	FF90754-288
	24	HK3317	A1917	A2917	A4906	A3906	A6936	A9904	FF90754-366
H1777	4	HK0913	A1901	A2901	A4900	A3900	A6910	A9901	FF90754-68
	5	HK1213	A1903	A2904	A4900	A3900	A6912	A9901	FF90754-91
	6	HK1213	A1904	A2904	A4900	A3900	A6912	A9902	FF90754-91
	8	HK1513	A1905	A2905	A4900	A3900	A6914	A9902	FF90754-122
H1812	4	HK1113	A1902	A2902	A4900	A3900	A6910	A9901	FF90754-79
	6	HK1313	A1904	A2904	A4900	A3900	A6912	A9902	FF90754-98
	8	HK1613	A1906	A2906	A4901	A3901	A6916	A9902	FF90754-122
	10	HK1713	A1908	A2908	A4901	A3901	A6920	A9902	FF90754-142
	12	HK2017	A1912	A2910	A4902	A3902	A6920	A9903	FF90754-173
	16	HK2517	A1913	A2913	A4904	A3904	A6924	A9903	FF90754-209
	20	HK2917	A1916	A2917	A4905	A3905	A6932	A9904	FF90754-288
	24	HK3317	A1917	A2917	A4906	A3906	A6936	A9904	FF90754-366

*Sizes indicated are based on Hose O.D. only. If sleeve is to be placed over fittings, a larger sleeve size may be required, depending on type of fitting used.

Accessories









Accessories to hose chart

K

Hose Type	Dash Size	Hose clamp	Round-wire spring guard	Flat-wire spring guard	Nylon(.045) abrasion sleeve	Nylon (.090) abrasion sleeve	Silicone fiberglass Firesleeve	Poly hose guard	Guardian sleeve
									
H1981	4	HK0913	A1901	A2901	A4900	A3900	A6910	A9901	FF90754-68
	5	HK1213	A1903	A2904	A4900	A3900	A6912	A9901	FF90754-91
	6	HK1313	A1904	A2904	A4900	A3900	A6912	A9902	FF90754-91
	8	HK1413	A1905	A2905	A4900	A3900	A6914	A9902	FF90754-122
	12	HK2117	A1912	A2910	A4902	A3902	A6920	A9903	FF90754-173
H1982	4	HK1213	A1903	A2904	A4900	A3900	A6912	A9901	FF90754-91
	5	HK1313	A1904	A2904	A4900	A3900	A6912	A9902	FF90754-91
	6	HK1313	A1905	A2905	A4900	A3900	A6914	A9902	FF90754-98
	8	HK1613	A1906	A2906	A4901	A3901	A6916	A9902	FF90754-122
	10	HK1813	A1908	A2909	A4902	A3902	A6920	A9903	FF90754-157
	12	HK1913	A1912	A2909	A4902	A3902	A6920	A9903	FF90754-157
	16	HK2517	A1913	A2913	A4904	A3904	A6924	A9903	FF90754-209
H1987	10	HK1713	A1907	A2907	A4901	A3901	A6916	A9902	FF90754-142
	12	HK1913	A1912	A2909	A4902	A3902	A6920	A9903	FF90754-157
H9949	4	HK1113	A1902	A2902	A4900	A3900	A6910	A9901	FF90754-79
	6	HK1313	A1904	A2904	A4900	A3900	A6912	A9902	FF90754-98
	8	HK1613	A1906	A2906	A4901	A3901	A6916	A9902	FF90754-122
	12	HK2017	A1912	A2910	A4902	A3902	A6920	A9903	FF90754-173
	16	HK2517	A1913	A2913	A4904	A3904	A6924	A9903	FF90754-209
35FH	40	HK0913	A1901	A2901	A4900	A3900	A6910	A9901	FF90754-68
	50	HK1013	A1902	A2901	A4900	A3900	A6910	A9901	FF90754-79
	60	HK1213	A1903	A2904	A4900	A3900	A6912	A9901	FF90754-91
GH001	4	HK0913	A1901	A2900	A4900	A3900	A6908	A9900	FF90754-68
	6	HK1113	A1902	A2902	A4900	A3900	A6910	A9901	FF90754-79
	8	HK1313	A1904	A2904	A4900	A3900	A6912	A9902	FF90754-98
	10	HK1413	A1905	A2905	A4900	A3900	A6914	A9902	FF90754-122
	12	HK1713	A1908	A2908	A4901	A3901	A6920	A9903	FF90754-142
	16	HK2117	A1912	A2911	A4903	A3903	A6924	A9903	FF90754-185
FC800	12	HK1913	A1912	A2909	A4902	A3902	A6920	A9903	FF90754-157
	16	HK2517	A1913	A2913	A4904	A3904	A6924	A9903	FF90754-209
	20	HK2617	A1913	A2913	A4904	A3904	A6928	A9903	FF90754-238
	24	HK3117	A1916	A2917	A4906	A3906	A6932	A9904	FF90754-288
S-Series	3	HK0709	A1901	A2900	A4900	A3900	A6908	A9900	FF90754-68
	4	HK0709	A1901	A2900	A4900	A3900	A6908	A9900	FF90754-68
	5	HK0809	A1901	A2900	A4900	A3900	A6908	A9900	FF90754-68
	6	HK0913	A1901	A2901	A4900	A3900	A6908	A9900	FF90754-68
	8	HK1113	A1902	A2902	A4900	A3900	A6910	A9901	FF90754-79
	10	HK1213	A1904	A2904	A4900	A3900	A6912	A9902	FF90754-91
	12	HK1413	A1905	A2905	A4900	A3900	A6914	A9902	FF90754-122
	16	HK1913	A1912	A2909	A4902	A3902	A6920	A9903	FF90754-157
	16Z	HK2017	A1912	A2910	A4902	A3902	A6920	A9903	FF90754-173
20Z	HK2517	A1913	A2913	A4904	A3904	A6924	A9903	FF90754-209	

*Sizes indicated are based on Hose O.D. only. If sleeve is to be placed over fittings, a larger sleeve size may be required, depending on type of fitting used.

*Sizes indicated are based on Hose O.D. only. If sleeve is to be placed over fittings, a larger sleeve size may be required, depending on type of fitting used.

Hose Type	Dash Size	Hose clamp	Round-wire spring guard	Flat-wire spring guard	Nylon(.045) abrasion sleeve	Nylon (.090) abrasion sleeve	Silicone fiberglass Firesleeve	Poly hose guard	Guardian sleeve
									
SC-Series	3	HK0709	A1901	A2900	A4900	A3900	A6908	A9900	FF90754-68
	4	HK0709	A1901	A2900	A4900	A3900	A6908	A9900	FF90754-68
	5	HK0809	A1901	A2900	A4900	A3900	A6908	A9900	FF90754-68
	6	HK0913	A1901	A2901	A4900	A3900	A6908	A9900	FF90754-68
	8	HK1113	A1902	A2902	A4900	A3900	A6910	A9901	FF90754-79
	10	HK1213	A1904	A2904	A4900	A3900	A6912	A9902	FF90754-91
	12	HK1413	A1905	A2905	A4900	A3900	A6914	A9902	FF90754-122
	16	HK1913	A1912	A2909	A4902	A3902	A6920	A9903	FF90754-157
S-TW Series	4	HK0709	A1901	A2900	A4900	A3900	A6908	A9900	FF90754-68
	5	HK0809	A1901	A2900	A4900	A3900	A6908	A9900	FF90754-68
	6	HK0913	A1901	A2901	A4900	A3900	A6908	A9900	FF90754-68
	7	HK1013	A1902	A2901	A4900	A3900	A6910	A9901	FF90754-79
	8	HK1013	A1902	A2901	A4900	A3900	A6910	A9901	FF90754-79
	10	HK1213	A1904	A2904	A4900	A3900	A6912	A9902	FF90754-91
	12	HK1413	A1905	A2905	A4900	A3900	A6914	A9902	FF90754-106
	14	HK1713	A1907	A2907	A4901	A3901	A6916	A9902	FF90754-142
	16	HK1813	A1912	A2909	A4902	A3902	A6920	A9903	FF90754-157
	18Z	HK2117	A1912	A2911	A4903	A3903	A6924	A9903	FF90754-185
SC-TW Series	4	HK0709	A1901	A2900	A4900	A3900	A6908	A9900	FF90754-68
	5	HK0809	A1901	A2900	A4900	A3900	A6908	A9900	FF90754-68
	6	HK0913	A1901	A2901	A4900	A3900	A6908	A9900	FF90754-68
	7	HK1013	A1902	A2901	A4900	A3900	A6910	A9901	FF90754-79
	8	HK1013	A1902	A2901	A4900	A3900	A6910	A9901	FF90754-79
	10	HK1213	A1904	A2904	A4900	A3900	A6912	A9902	FF90754-91
	12	HK1413	A1905	A2905	A4900	A3900	A6914	A9902	FF90754-106
	14	HK1613	A1907	A2907	A4901	A3901	A6916	A9902	FF90754-142
	16	HK1813	A1912	A2909	A4902	A3902	A6920	A9903	FF90754-157
	18Z	HK2117	A1912	A2911	A4903	A3903	A6924	A9903	FF90754-185
HI-PSI Series	4	HK0809	A1900	A2900	A4900	A3900	A6908	A9900	FF90754-68
	6	HK1013	A1900	A2901	A4900	A3900	A6910	A9901	FF90754-79
	8	HK1213	A1903	A2904	A4900	A3900	A6912	A9901	FF90754-91
	10	HK1413	A1905	A2905	A4900	A3900	A6914	A9902	FF90754-106
	12	HK1713	A1908	A2908	A4901	A3901	A6916	A9902	FF90754-142
	16	HK2317	A1912	A2912	A4903	A3903	A6924	A9903	FF90754-185
	20	HK2917	A1913	A2913	A4904	A3904	A6928	A9904	FF90754-238
	24	HK3117	A1916	A2917	A4906	A3906	A6932	A9904	FF90754-288
	24	HK3117	A1916	A2917	A4906	A3906	A6932	A9904	FF90754-288
	32	HK3817	—	—	A4907	A3907	A6948	A9904	—
8000 Series	8	HK1513	A1905	A2905	A4900	A3900	A6914	A9902	FF90754-122
	12	HK1913	A1912	A2910	A4902	A3902	A6920	A9903	FF90754-157
	16	HK2317	A1913	A2912	A4904	A3904	A6924	A9903	FF90754-209
	20	HK2917	A1913	A2913	A4904	A3904	A6928	A9904	FF90754-238
	24	HK3117	A1916	A2917	A4906	A3906	A6932	A9904	FF90754-288
	32	HK3817	—	—	A4907	A3907	A6948	A9904	—
8500 Series	8	HK1513	A1905	A2905	A4900	A3900	A6914	A9902	FF90754-122
	12	HK1913	A1912	A2910	A4902	A3902	A6920	A9903	FF90754-157
	16	HK2317	A1913	A2912	A4904	A3904	A6924	A9903	FF90754-209
	20	HK2917	A1913	A2913	A4904	A3904	A6928	A9904	FF90754-238
	24	HK3117	A1916	A2917	A4906	A3906	A6932	A9904	FF90754-288
	32	HK3817	—	—	A4907	A3907	A6948	A9904	—

Accessories

Ready-made hose assemblies

K

15CA Eclipse Air brake coil

Meets: SAE J844 Type B, DOT-FMVSS 106, (49 FR571.106)



Part number	Description	Valve pigtail length		Male ends				Working length	
				Valve		Gladhand			
		mm	in	mm	in	mm	in	mm	ft
15CA12-12	15' WL abt coil set w/ 12" pigtails	304,8	12	12,7	0.50	12,7	0.50	4,6	15
15CA48-12	15' WL abt coil set w/ 48" pigtails	1.219,2	48	12,7	0.50	12,7	0.50	4,6	15
15CAR12-12	15' WL single, red abt coil w/ 12" pigtails	304,8	12	12,7	0.50	12,7	0.50	4,6	15
15CAB12-12	15' WL single, blue abt coil w/ 12" pigtails	304,8	12	12,7	0.50	12,7	0.50	4,6	15
15CAR48-12	15' WL single, red abt coil w/ 48" pigtails	1.219,2	48	12,7	0.50	12,7	0.50	4,6	15
15CAB48-12	15' WL single, blue abt coil w/ 48" pigtails	1.219,2	48	12,7	0.50	12,7	0.50	4,6	15
12CA12-12	12' WL abt coils set w/ 12" pigtails	304,8	12	12,7	0.50	12,7	0.50	3,7	17
12CAR12-12	12' WL single, red abt coil w/ 12" pigtails	304,8	12	12,7	0.50	12,7	0.50	3,7	17
12CAB12-12	12' WL single, blue abt coil w/ 12" pigtails	304,8	12	12,7	0.50	12,7	0.50	3,7	17
20CA12-12	20' WL abt coil set w/ 12" pigtails	304,8	12	12,7	0.50	12,7	0.50	6,1	20

Construction

Tube: Synflex Eclipse air brake tubing, 100% polyamide

Reinforcement:

Polyester yarn

Brass end fitting with corrosion resistant spring guard

Operating parameters

-54°C to +93°C
(-65°F to +200°F)

Application

- Articulating connections for air brake line systems (connections between towed and towing motor vehicle)
- Tractor-to-trailer air connections used in extremely low temperatures

Features

- Superior abrasion resistance
- Excellent return and coil memory
- Enhanced flexibility and extension
- Brass end fittings with corrosion resistant spring guards

WARNING: California Proposition 65, see page A-2.

Gladhand couplings

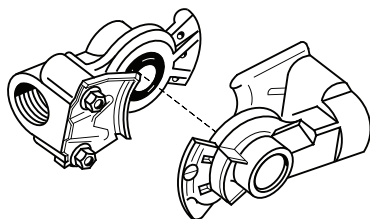

Part number

Part number	Description
W79850	Service – Signal (Connects only to service)
W79851	Emergency – Supply line (Connects only to emergency)
W76150	Universal (Connects to all three styles)
W14630**	Gladhand Seal

** For use with W79850, W79851, and W76150 gladhands

Construction

Die cast aluminum body

Features

- Conform to SAE J318
- Connect to 1/2" pipe

3SCE Eclipse Fifth-wheel slider coil

Meets: SAE J844 Type B, DOT-FMVSS 106, (49 FR571.106)



Construction

Tube: Synflex Eclipse air brake tubing, 100% polyamide

Reinforcement:
Polyester yarn

Brass end fitting with corrosion resistant spring guard

Operating parameters

-54°C to +93°C
(-65°F to +200°F)

Part number	Valve pigtail length		End fitting	Working length		Retracted length	
	mm	in		mm	ft	mm	in
3SCE-0303304-033	88,9	3.50	None	1.371,6	54.00	254,0	10.00
3SCE-0303304-166	88,9	3.50	1/4" male pipe	1.371,6	54.00	254,0	10.00

Application

- Articulating connections for air brake line systems (connections between towed and towing motor vehicle)
- Tractor-to-trailer air connections used in extremely low temperatures with enhanced flexibility and extension

WARNING: California Proposition 65, see page A-2.

Air Compressor discharge Teflon hose assembly

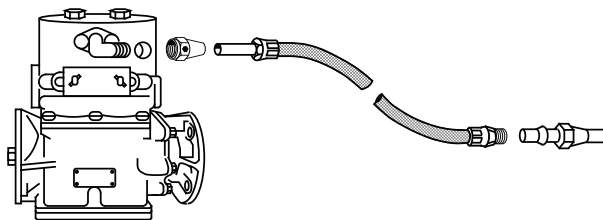

Ready-made hose Teflon assemblies eliminate tubing failures caused by vibration and heat. They make excellent replacements for troublesome copper tubing running from the air compressor discharge to the reservoir. The assemblies are easy to install with standard air brake nuts and sleeves. No special fittings or adapters are needed.

Maximum working pressure

1,000 psi

Operating temperature range

-65°F to +450°F
(-18°C to +232°C)

Standpipe to Standpipe



Description	Length	Part number
5/8" hose I.D. – 5/8" tube	24"	WTT024
	36"	WTT036
5/8" hose I.D. – 3/4" tube	36"	WTT236

SAE 45° Flare to SAE 45° Flare



Description	Length	Part number
1/2" hose I.D. – 5/8" tube	34"	W44034
	38"	W44038
	40"	W44040
	42"	W44042
	48"	W44048
	50"	W44050
	52"	W44052
	54"	W44054
	67"	W44067

Teflon is a trademark of The Chemours Company FC, LLC used under license by Eaton.

Accessories

Ready-made hose assemblies

K

Grease hose whip ends for high-pressure grease applications

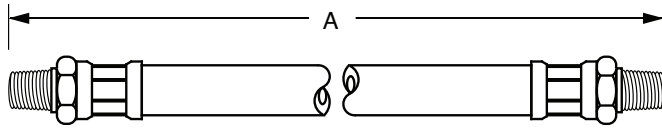

Part Number	Tube O.D.	Male Pipe	Working Length	Pigtail Length
11312	1/8-27	3/16"	12"	Rubber
11318	1/8-27	3/16"	18"	Rubber
11358	1/8-27	3/16"	18"	Nylon

Note: Use with hand-operated grease gun only!

Maximum operating pressure

3,000 psi

Operating temperature range

-40°F to +200°F (-40°C to +93°C)

Hose Part No.

H993903

Power trim Teflon hose assembly

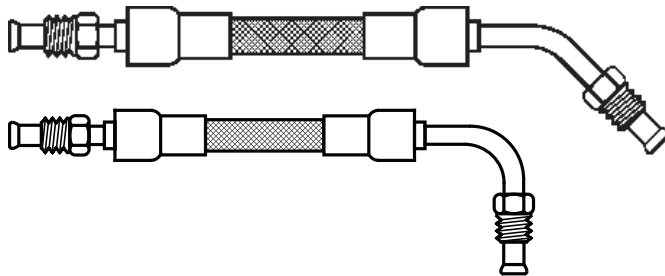

Part Number	Overall Length	Fitting Description
1909	14-1/2"	3/16" Inv. Nut Straight x 3/16" Inv. Nut 90° Elbow
1910	14-1/2"	3/16" Inv. Nut Straight x 3/16" Inv. Nut 45° Elbow

Teflon is a trademark of The Chemours Company FC, LLC used under license by Eaton.

Expand service to marinas with the inboard/outboard power trim Teflon hose assemblies, available in the most popular size, 3/16" I.D., 14-1/2" long, with inverted nut end styles.

Marine applications will benefit from the non-aging and temperature resistant qualities of Teflon, plus the corrosion resistance of 300 Series stainless steel fittings and braid.

Maximum operating pressure

3,000 psi

Operating temperature range

-65°F to +450°F

Air brake air chamber hose lines

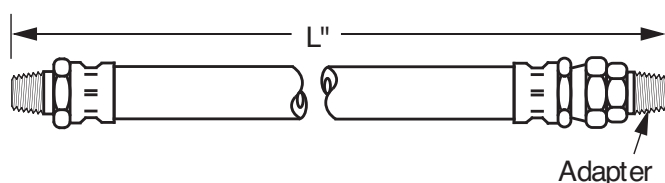

Features / Benefits

- Low cost
- Ready to install
- Available in both 3/8" and 1/2" I.D.

Hose Part No.

EC038 Weatherhead air brake hose

Hose Assembly I.D.	Male pipe	Air brake swivel*	Length L	Factory made assembly Part number**
1/2"	3/8"	3/8"	15"	38353-01500
1/2"	3/8"	3/8"	16"	38353-01600
1/2"	3/8"	3/8"	18"	38353-01800
1/2"	3/8"	3/8"	19"	38353-01900
1/2"	3/8"	3/8"	20-3/8"	38353-02037
1/2"	3/8"	3/8"	22"	38353-02200
1/2"	3/8"	3/8"	23"	38353-02300
1/2"	3/8"	3/8"	24"	38353-02400
1/2"	3/8"	3/8"	26"	38353-02600
1/2"	3/8"	3/8"	28-3/8"	38353-02837
1/2"	3/8"	3/8"	30"	38353-03000
1/2"	3/8"	3/8"	32"	38353-03200
1/2"	3/8"	3/8"	34-3/8"	38353-03437
1/2"	3/8"	3/8"	36"	38353-03600
1/2"	3/8"	3/8"	41-1/8"	38353-04112
1/2"	3/8"	3/8"	44"	38353-04400
1/2"	3/8"	3/8"	46"	38353-04600
1/2"	3/8"	3/8"	48"	38353-04800
1/2"	3/8"	3/8"	60"	38353-06000
1/2"	3/8"	3/8"	72"	38353-07200

*Includes 3/8" A.B.S. to 3/8" male pipe adapter.

**Air chamber hose assemblies can also be made using Eaton Weatherhead EC038 hose, 33808P-106 and 33808P-Y76 hose ends, and 1390x6x6 adapter.

Hose Assembly I.D.	Male pipe	Air brake swivel*	Length L	Factory made assembly Part number**
3/8"	1/4"	3/8"	18-1/8"	38166-01812
3/8"	1/4"	3/8"	20-3/8"	38166-02137
3/8"	1/4"	3/8"	22"	38166-02200
3/8"	1/4"	3/8"	24-1/8"	38166-02412
3/8"	1/4"	3/8"	24-7/8"	38166-02487
3/8"	1/4"	3/8"	26"	38166-02600
3/8"	1/4"	3/8"	27-5/8"	38166-02762
3/8"	1/4"	3/8"	28-3/8"	38166-02837
3/8"	1/4"	3/8"	29-1/8"	38166-02912
3/8"	1/4"	3/8"	30-1/8"	38166-03012
3/8"	1/4"	3/8"	32"	38166-03200
3/8"	1/4"	3/8"	34"	38166-03400
3/8"	1/4"	3/8"	34-3/8"	38166-03437
3/8"	1/4"	3/8"	36-1/8"	38166-03612
3/8"	1/4"	3/8"	38-1/8"	38166-03812
3/8"	1/4"	3/8"	40"	38166-04000
3/8"	1/4"	3/8"	41-1/8"	38166-04112
3/8"	1/4"	3/8"	42"	38166-04200
3/8"	1/4"	3/8"	48"	38166-04800
3/8"	1/4"	3/8"	60"	38166-06000
3/8"	1/4"	3/8"	72"	38166-07200

*Includes 3/8" A.B.S. to 3/8" male pipe adapter.

**Air chamber hose assemblies can also be made using Eaton Weatherhead EC038 hose, 33808P-106 and 33808P-Y76 hose ends, and 1390x6x6 adapter.

Hose Assembly I.D.	Male pipe	Air brake swivel*	Length L	Factory made assembly Part number**
3/8"	3/8"	3/8"	18"	38097-01800
3/8"	3/8"	3/8"	20"	38097-02000
3/8"	3/8"	3/8"	24"	38097-02400
3/8"	3/8"	3/8"	26"	38097-02600
3/8"	3/8"	3/8"	28"	38097-02800
3/8"	3/8"	3/8"	30"	38097-03000
3/8"	3/8"	3/8"	32"	38097-03200
3/8"	3/8"	3/8"	34"	38097-03400
3/8"	3/8"	3/8"	40"	38097-04000
3/8"	3/8"	3/8"	42"	38097-04200
3/8"	3/8"	3/8"	60"	38097-06000
3/8"	3/8"	3/8"	72"	38097-07200

*Includes 3/8" A.B.S. to 3/8" male pipe adapter.

**Air chamber hose assemblies can also be made using Eaton Weatherhead EC038 hose, 33808P-106 and 33808P-Y76 hose ends, and 1390x6x6 adapter.

Accessories

Ready-made hose assemblies

K

Automobile, light truck gas/oil lines

Maximum working pressure

50 psi

Temperature range

-40°F to +257°F

Weatherhead H057 Hose

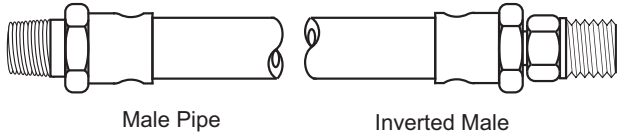

Part number	Overall length	Fitting description
11461	10"	1/8" Male pipe x 1/4" Inv. Male
11462	12"	1/8" Male pipe x 1/4" Inv. Male
11463	13"	1/8" Male pipe x 1/4" Inv. Male
11464	15"	1/8" Male pipe x 1/4" Inv. Male
11465	21"	1/8" Male pipe x 1/4" Inv. Male
11466	28"	1/8" Male pipe x 1/4" Inv. Male
11474	19"	1/8" Male pipe x 1/4" Inv. Male
11477	17"	1/8" Male pipe x 1/4" Inv. Male
11478	24"	1/8" Male pipe x 1/4" Inv. Male

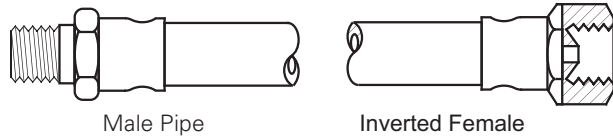

Part number	Overall length	Fitting description
11079	6-5/8"	1/8" Male pipe x 5/16" Inv. Female
11076	8-1/4"	1/8" Male pipe x 5/16" Inv. Female
11205	8-7/8"	1/8" Male pipe x 5/16" Inv. Female
11215	9-3/8"	1/8" Male pipe x 5/16" Inv. Female
11093	18"	1/8" Male pipe x 5/16" Inv. Female
11217	7-1/2"	1/4" Male pipe x 3/8" Inv. Female
11216	9"	1/4" Male pipe x 3/8" Inv. Female

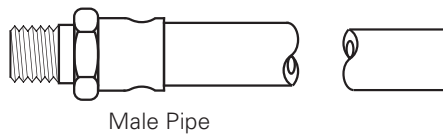

Part number	Overall length	Fitting description
11223	15-1/4"	1/4" Male pipe (one end only, other end blank)

Automobile, light truck gas/oil lines*

Maximum working pressure

50 psi

Temperature range

-40°F to +257°F

Weatherhead H057 Hose

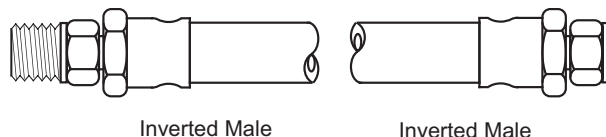

Inverted Male

Inverted Male

Part number	Overall length	Fitting description
11486	10"	1/4" Inv. Male x 1/4" Inv. Male

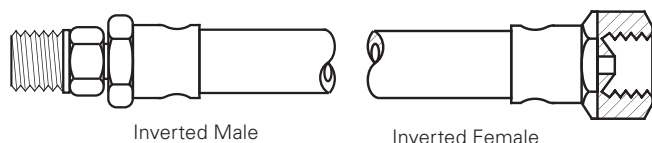

Inverted Male

Inverted Female

Part number	Overall length	Fitting inverted description
11080	5"	1/4" Male x 1/4" Female
11224	7"	1/4" Male x 1/4" Female
11089	10-5/8"	1/4" Male x 1/4" Female
11078	7"	5/16" Male x 5/16" Female
11212	7-7/8"	5/16" Male x 5/16" Female
11041	9"	5/16" Male x 5/16" Female
11208	10-3/4"	5/16" Male x 5/16" Female
11219	6-1/4"	5/16" Male x 5/16" Female

Automobile, light truck universal-type filter lines*

(1/4" SAE Swivel Nut to 1/8" Male Pipe)

Maximum operating pressure

400 psi

Operating temperature range

-40°F to +250°F

Weatherhead H05804 Hose



Note: Hose end material is brass.

*Hose assemblies listed are for automobile or light truck (up to 3/4-ton pickup truck) application only. Consult Eaton prior to any other use.

Part number	Overall length	Part number	Overall length
81430-08	8"	81430-20	20"
81430-10	10"	81430-22	22"
81430-12	12"	81430-24	24"
81430-14	14"	81430-28	28"
81430-16	16"	81430-30	30"
81430-18	18"	81430-36	36"

WARNING: California Proposition 65, see page A-2.

Accessories

Hose assembly

K

Hose insertion gauges

FF90308



Improve hose assembly reliability with these easy to use aluminum gauges that are designed to ensure proper fitting depth during pre-assembly.

Simply bottom the hose in the appropriately marked cavity and scribe a mark on the hose flush with the top surface of the gauge. Insert the fitting until the back of the socket is aligned with scribe line.

Part number	Usage
FF90308-01	For use with all hoses that mate with -4 through -16 Z-series fittings
FF90308-02	For use with all hoses that mate with -20, -24, -32 Z-series fittings
FF90308-04	For use with all hoses that mate with -06, -08, -10, -12, -16 spiral 4S/6S fittings
FF90308-05	For use with all hoses that mate with -20, -24, -32 spiral 4S/6S fittings

Pressure gauge kit

FF14802



Kit FF14802 Component Part numbers	Description	Quantity Per Kit
FF14783	1/8" NPT Test Coupling	2
FF14784	1/4" NPT Test Coupling	2
FF14787	7/16-20 UNF Test Coupling	1
FF14788	9/16-20 UNF Test Coupling	1
FF14794	1/4" NPT Gauge Adapter	3
FF14796	Union Adapter	2
FF14798	60" Test Hose Assembly	2
FF14799	(-) 30 in/Hg - 30 psi Gauge	1
FF14800	1,000 psi Gauge	1
FF14801	7,500 psi Gauge	1

Hose spacers

HSM-48



Hose spacers keep hoses organized and prevents hose abrasion at the points of contact.

Part number	Description
HSM-48	Case of 48 mixed hose spacers

Features

- Prevents damage from unrestrained hoses
- Available in 4 sizes – 3/4", 1", 1-1/8", 1-3/8"
- Packed in colorful counter display boxes of 48 – cable ties included
- Also available in mixed boxes of 48 (12 each size) or refill bags of 12

Hose protectors

HP4, HP6, HP8 and HPM



*Hose protectors available in black, orange or yellow.

Easy installation in minutes – no need to remove hose, formulated to resist solvents, oils, grease and gasoline.

Part number	Description
HP4*	4" Hose Protector Case of 50
HP6*	6" Hose Protector Case of 50
HP8*	8" Hose Protector Case of 50
HPM*	Mixed Hose Protectors Case of 60

Features

- Operating temperature range is -40° to 430°F
- Exceptionally cost effective
- Packed in easy to assemble, colorful, counter display box – cable ties included
- Available in 3 sizes: 4", 6" and 8"

Abrasion protection for

- Hydraulic hose
- Battery cables
- Wiring harness
- Brake systems
- Fuel lines
- Air lines
- Radiator hose
- Oil lines

Market applications:

- Farming
- Industrial
- Trucking
- Mining
- Construction
- Public transportation
- Aviation support
- Road maintenance
- Waste management
- Original equipment manufacturer

Accessories

Hose protection

K

Flaretite seals



The ideal product to enhance new installations of SAE 37° connections, as well as seal off minor leaks and weeping connections. Available sizes: -04 through -32.

Features

- Ribbed insert design
- Coated with Loctite sealant
- Economical method to reduce minor leaks and weeping connections
- Built-in clip to attach the Flaretite seal to the nose of the SAE 37° connection

Benefits

- Multiple surface contact points
- Locks the joint and fills surface imperfections
- Saves time & money associated with maintenance and rework
- Quick & easy assembly

Seal size	Package part number	Number of seals per package
-04	FF13267	100
-06	FF13268	100
-08	FF13269	100
-10	FF13270	100
-12	FF13271	100
-16	FF13272	50
-20	FF13273	50
-24	FF13570	25
-32	FF13571	10

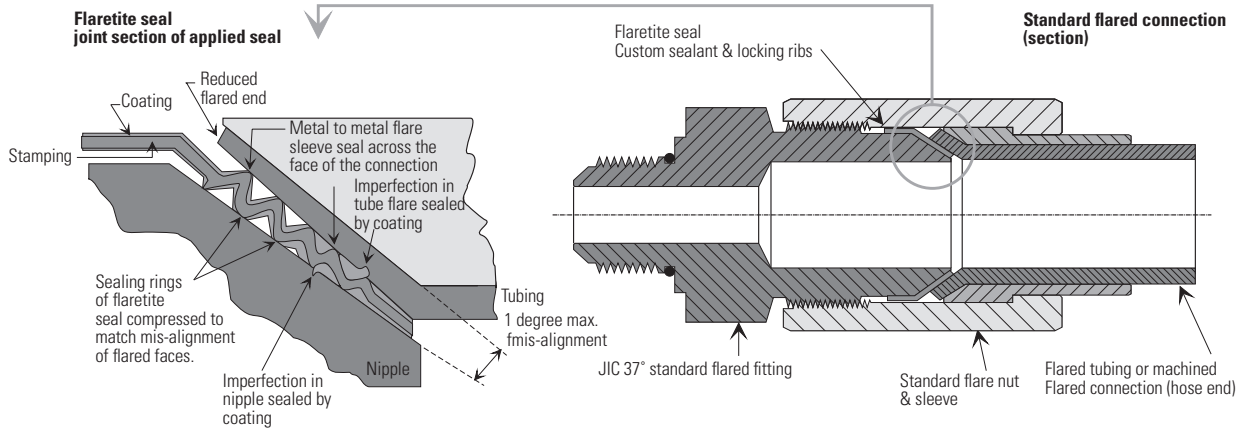

Assembly and torque requirements

To assemble an SAE 37° connection using a Flaretite seal, simply push the Flaretite seal onto the male portion of the connection. The built-in clip will hold the Flaretite seal onto the male half.

During assembly ensure:

- The seal is fitted squarely to the conical nose of the JIC fitting -37° flare.
- The sealing faces of the flared connector part are clean and free of burrs.
- The flared joint is correctly tightened with recommended torque settings noted below.

Recommended torque settings:

Tolerance: +10% -0%

-04 (1/4")	SAE 37°: 14lb-ft.	-10 (5/8")	SAE 37°: 80lb-ft.	-20 (1-1/4")	SAE 37°: 190lb-ft.
-06 (3/8")	SAE 37°: 26lb-ft.	-12 (3/4")	SAE 37°: 110lb-ft.	-24 (1-1/2")	SAE 37°: 220lb-ft.
-08 (1/2")	SAE 37°: 55lb-ft.	-16 (1")	SAE 37°: 140lb-ft.	-32 (2")	SAE 37°: 325lb-ft.

* Flaretite is a registered trademark of Flaretite Inc.
 All photos and the name Flaretite are the property of Flaretite Inc.
 ** Loctite is a registered trademark of the Henkel Corporation.

Bundling sleeves



Hydraulic lines are often subjected to tremendous stress and wear during use. Lines that are allowed to move freely are easily abraded, crimped, or cut. Common methods for binding hydraulic lines, such as cable ties, can restrict movement too much as the lines expand and contract.

Bundling sleeves hold lines securely in place to protect them from damage, while providing enough flexibility for normal operation.

The sleeves can be removed and replaced quickly, allowing easy access for hose repair.

Specifications

Part number	Fits Bundle outer diameter	Circumference of Bundle to be covered (laid flat)	sleeve width	bulk roll length (ft)	length tolerance
A4926	2	6.0	7-3/4	150	(+1 ft., - 0 ft)
A4927	3	9.4	11	150	(+1 ft., - 0 ft)
A4928	4	12.5	14	150	(+1 ft., - 0 ft)
A4929	5	15.7	17-1/4	150	(+1 ft., - 0 ft)
A4930	6	18.8	20-3/8	150	(+1 ft., - 0 ft)

Construction

1050 Ballistit nylon, .71 mm thickness

Urethane coating

Color

Black

Operating temperature range

175° F

Features

- Tight bundling and secure hose containment
- Resistant to heat, ozone, and abrasion
- Easy removal and replacement

Benefits

- Increase productivity in assembly and reassembly of hose bundles
- Reduce contamination of hose during bundle assembly
- Force routing of hydraulic lines for safety and efficiency
- Reduce risk of hose bursts, resulting in greater operator safety
- Reduce time spent on field repairs
- Replace inefficient bundling methods and line-damaging cable ties
- Eliminate cumbersome winding of spiral-formed products
- Reduce old-sock-syndrome bunching at end of bundled lines
- Eliminate line contamination during hose replacement

How to order Bundling sleeves

- Part numbers above are stocked in 150 foot shrink –wrapped bulk rolls, as rolled up and unfastened
- Orders the number of rolls needed, not footage.
- 150 foot bulk rolls are one continuous length.
- Order per foot

Accessories

Hose protection

K

Bundling straps

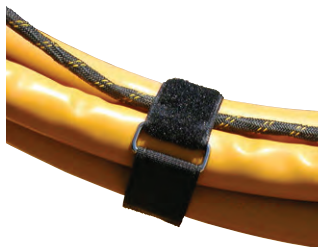

Bundling straps hold hose, cables, pipes, tubes, and other items securely in place. They can be removed, adjusted, and put back in place easily.

Unlike cable ties, bundling straps allow hose and tubes to expand and contract in changing conditions. Cable ties cannot be reused. Bundling straps, however, can be used again and again, with no loss of strength. Their hook-and-loop fasteners, developed for industrial applications, the safety industry, and the military, have superior sheer strength and peel compared to those used in the garment industry.

Construction

Standard Duty

1050 Ballistic nylon II webbing, .71 mm thickness with dense nylon backing

Delrin plastic fastening loop on cinch and hanging straps

Urethane coating

Heavy Duty

1000 nylon webbing, 3.18 mm thickness with dense nylon backing

Nickel-plated steel 12 L.14 fastening loop on cinch and hanging straps

Urethane coating

Color

Black

Operating temperature range

-40° to +250° F

Cinching strap (CS Series) bundling straps are designed for economical service applications, such as hose and cable bundling. All joints are ultrasonically welded and tested.

Hanging strap (HS Series) bundling straps are held in place by a 3/8" grommet. The straps can be mounted vertically or horizontally.

Both cinching and hanging straps are available in standard duty or heavy duty. Heavy-duty bundling straps are designed for severe industrial applications and ultrasonically welded to 1-1/2" hook-and-loop material. All heavy-duty hardware is nickel-plated steel.

Bundling straps are sold in packages of five, and discounts are offered for volume quantities of 50, 100, 250, 500, and 1,000. Special sizes, materials, colors, and configurations are available. Ordering information on next page.

Features

- Easy to remove and replace
- Adjustable to any size bundle
- Industrial strength strap fabric and fasteners
- Secure containment of hose, cables, and other items
- Clean professional appearance

Benefits

- Reduce cost of managing cables and hose
- Improve worker safety and productivity
- Reduce abrasion of bundles items
- Save money through reusability

Merchandising kits for Bundling straps



Standard duty kit

Part Number **FF13502**

Heavy duty kit

Part Number **FF13503**

Kit contains

Each merchandising kit comes with a quantity of individually cellophane-wrapped bundling straps in both cinch and hanging styles for bundling diameters of 8", 12", 16", and 20 inches. Resupply the merchandising kit by ordering the individually wrapped straps listed on the next page.

The box has a pop-up lid that can be positioned upright, making an effective advertising backdrop. Attached to the merchandising box is a handy bundling strap for demonstration purposes.

Note: Kit boxes are stocked with approximately half the available strap capacity to allow for lower kit pricing at startup.

Bundling straps

(continued)



Cinch straps

Bulk packed or
Individually wrapped



Hanging straps

Bulk packed or
Individually wrapped

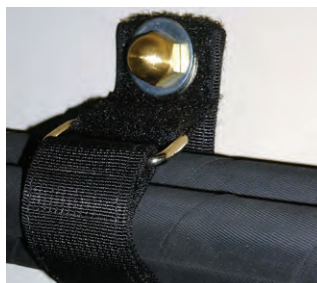

Cinch straps

Standard duty

Standard duty		Heavy duty		Circumference of hose bundle	Strap length (flat)	Ordering measurement
Bulk packed	Individually cellophane wrapped	Bulk packed	Individually cellophane wrapped			
Part number	Part number	Part number	Part number			
FF90519-4	FF90520-4	FF90521-4	FF90522-4	4"	7-3/4"	Each
FF90519-6	FF90520-6	FF90521-6	FF90522-6	6"	11"	Each
FF90519-8	FF90520-8	FF90521-8	FF90522-8	8"	14"	Each
FF90519-10	FF90520-10	FF90521-10	FF90522-10	10"	17-1/4"	Each
FF90519-12	FF90520-12	FF90521-12	FF90522-12	12"	20-3/8"	Each
FF90519-14	FF90520-14	FF90521-14	FF90522-14	14"		Each
FF90519-16	FF90520-16	FF90521-16	FF90522-16	16"		Each
FF90519-18	FF90520-18	FF90521-18	FF90522-18	18"		Each
FF90519-20	FF90520-20	FF90521-20	FF90522-20	20"		Each
	FF90520-22	FF90521-22		22"		Each
	FF90520-24	FF90521-24		24"		Each
	FF90520-26	FF90521-26		26"		Each

Hanging straps

Standard duty

Standard duty		Heavy duty		Circumference of hose bundle	Strap length (flat)	Ordering measurement
Bulk packed	Individually cellophane wrapped	Bulk packed	Individually cellophane wrapped			
Part number	Part number	Part number	Part number			
FF90523-4	FF90524-4	FF90525-4	FF90526-4	4"	7-3/4"	Each
FF90523-6	FF90524-6	FF90525-6	FF90526-6	6"	11"	Each
FF90523-8	FF90524-8	FF90525-8	FF90526-8	8"	14"	Each
FF90523-10	FF90524-10	FF90525-10	FF90526-10	10"	17-1/4"	Each
FF90523-12	FF90524-12	FF90525-12	FF90526-12	12"	20-3/8"	Each
FF90523-14	FF90524-14	FF90525-14	FF90526-14	14"		Each
FF90523-16	FF90524-16	FF90525-16	FF90526-16	16"		Each
FF90523-18	FF90524-18	FF90525-18	FF90526-18	18"		Each
FF90523-20	FF90524-20	FF90525-20	FF90526-20	20"		Each
		FF90525-22	FF90526-22	22"		Each
		FF90525-24	FF90526-24	24"		Each
		FF90525-26	FF90526-26	26"		Each

WARNING: Do not use this product for overhead lifting, support of human weight or athletic equipment, or other situations where personal safety or valuable property can be endangered.

Accessories

Hose clamps

K

Round-wire clamps

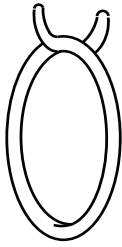

Clamp size	Hose size	Part number	Minimum diameter	Maximum diameter	Nominal diameter
06	1/4	1538	.370	.380	.375
08	5/16	1539	.551	.573	.562
10	3/8	1540	.610	.640	.625

Construction

Carbon steel spring wire,
Zinc-plated

Application

- Industrial
- Automotive
- Agriculture
- General market applications

E.F.I. Hose clamps

Electronic fuel injection hose clamps

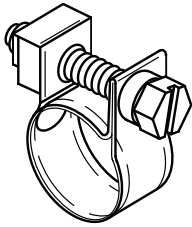

Clamp size	Part number	Minimum diameter	Maximum diameter	Nominal diameter
04	6207-004	.433	.551	.512
05	6207-005	.472	.590	.551
06	6207-006	.551	.669	.630

Construction

Plated carbon steel
23/64" (9mm) band width

FF90311

Heavy-duty hose support clamps



Heavy-duty weld-based clamps are designed to securely hold hose in applications subject to impulsing, flexing, and vibrating conditions.

The clamps help prevent abrasion and extend hose life through proper routing. Clamps are rated to ambient temperature of +250°F.

Part number	Inside Diameter	
	(mm)	(in)
FF90311-127	12.70	0.50
FF90311-137	13.70	0.54
FF90311-150	15.00	0.59
FF90311-160	16.00	0.63
FF90311-171	17.10	0.67
FF90311-174	17.40	0.69
FF90311-190	19.00	0.75
FF90311-205	20.50	0.81
FF90311-222	22.20	0.87
FF90311-239	23.90	0.94
FF90311-254	25.40	1.00
FF90311-266	26.60	1.05
FF90311-280	28.00	1.10
FF90311-300	30.00	1.18
FF90311-320	32.00	1.26
FF90311-334	33.40	1.31
FF90311-357	35.70	1.41
FF90311-381	38.10	1.50
FF90311-400	40.00	1.57
FF90311-422	42.20	1.66
FF90311-445	44.50	1.75
FF90311-483	48.30	1.90
FF90311-508	50.80	2.00
FF90311-572	57.20	2.25
FF90311-635	63.50	2.50
FF90311-700	70.00	2.76

Partial Stainless steel clamps

Full-sized and Micro-sized clamps SAE J1508 Type F

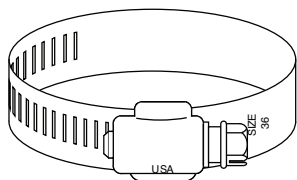

Partial stainless steel clamps utilize a 300 Series stainless steel band and housing with a steel case-hardened, zinc-plated screw. They feature a 14.3mm (9/16") band housing with a 8mm (5/16") hexagon and screwdriver slotted screw.

Application

- Heavy-duty equipment
- Agriculture
- General industry

Clamp size	Part number	Minimum diameter	Maximum diameter	Nominal diameter
*004	6205-004	7/32	5/8	1/4
*006	6205-006	5/16	7/8	1/2
006	6203-006	3/8	7/8	1/2
008	6203-008	7/16	1	9/16
010	6203-010	9/16	1-1/16	5/8
012	6203-012	9/16	1-1/4	3/4
016	6203-016	11/16	1-1/2	1
020	6203-020	3/4	1-3/4	1-1/4
024	6203-024	1-1/16	2	1-1/2
028	6203-028	1-5/16	2-1/4	1-3/4
032	6203-032	1-9/16	2-1/2	2
036	6203-036	1-13/16	2-3/4	2-1/4
040	6203-040	2-1/16	3	2-1/2
044	6203-044	2-5/16	3-1/4	2-3/4
048	6203-048	2-9/16	3-1/2	3
052	6203-052	2-13/16	3-3/4	3-1/4
056	6203-056	3-1/16	4	3-1/2
064	6203-064	3-9/16	4-1/2	4
072	6203-072	4-1/16	5	4-1/2
080	6203-080	4-5/8	5-1/2	5
088	6203-088	4-3/32	6	5-1/2
096	6203-096	4-1/2	6-1/2	6
104	6203-104	5	7	6-1/2

*Micro-sized clamps

All Stainless steel clamps

Full-sized and Micro-sized clamps SAE J1508 Type F

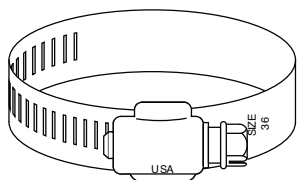

Clamps with an all stainless steel construction offers maximum protection against corrosion.

Full-sized all stainless clamps have a 14.3mm (9/16") band and housing manufactured with 300 Series stainless steel. The 8mm (5/16") hexagon and screwdriver slotted screw.

Micro-sized all stainless clamps have a 5/16" (8mm) band and housing manufactured with 300 Series stainless steel. The 6.35mm (1/4") hexagon and screwdriver slotted screw features 410 stainless steel.

Application

- Chemical
- Marine
- Food processing
- Dairy
- Automotive
- Electrical
- Plumbing

Clamp size	Part number	Minimum diameter	Maximum diameter	Nominal diameter
*004	6206-004	7/32	5/8	1/4
*006	6206-006	5/16	7/8	1/2
006	6204-006	3/8	7/8	1/2
008	6204-008	7/16	1	9/16
010	6204-010	9/16	1-1/16	5/8
012	6204-012	9/16	1-1/4	3/4
016	6204-016	11/16	1-1/2	1
020	6204-020	3/4	1-3/4	1-1/4
024	6204-024	1-1/16	2	1-1/2
028	6204-028	1-5/16	2-1/4	1-3/4
032	6204-032	1-9/16	2-1/2	2
036	6204-036	1-13/16	2-3/4	2-1/4
040	6204-040	2-1/16	3	2-1/2
044	6204-044	2-5/16	3-1/4	2-3/4
048	6204-048	2-9/16	3-1/2	3
052	6204-052	2-13/16	3-3/4	3-1/4
056	6204-056	3-1/16	4	3-1/2
064	6204-064	3-9/16	4-1/2	4
072	6204-072	4-1/16	5	4-1/2
080	6204-080	4-5/8	5-1/2	5
088	6204-088	4-3/32	6	5-1/2
096	6204-096	4-1/2	6-1/2	6
104	6204-104	5	7	6-1/2

*Micro-sized clamps

